

DISS. ETH NO. 15228

**SUCCESSION IN A PROTECTION FOREST AFTER
PICEA ABIES DIE-BACK**

**A dissertation submitted to the
SWISS FEDERAL INSTITUTE OF TECHNOLOGY ZÜRICH**

for the degree of
Doctor of Natural Sciences

presented by

ANDREA DORIS KUPFERSCHMID ALBISETTI

Dipl. phil. nat., University of Bern

born 5. 11. 1973

citizen of Sumiswald BE and Meride TI

accepted on the recommendation of

Prof. Dr. H. Bugmann, examiner

Dr. W. Schönenberger, co-examiner

Dr. P. Brang, co-examiner

2003

Contents

I	INTRODUCTION.....	11
I A	MOUNTAIN FORESTS AND PROTECTION AGAINST NATURAL HAZARDS	11
I B	MOTIVATION AND OBJECTIVES OF THE STUDY	22
I C	STUDY OVERVIEW	25
II	MATERIAL AND METHODS	26
II A	STUDY SITE GANDBERG	26
II B	OVERVIEW OF THE FIELD SURVEYS.....	33
III	SHORT-TERM SUCCESSION	40
III A	DECAY PROCESS.....	40
III B	DEVELOPMENT OF GROUND VEGETATION.....	54
III C	DEVELOPMENT OF TREE REGENERATION	63
IV	LONG-TERM SUCCESSION	80
IV A	REVIEW OF FOREST SUCCESSION MODELS WITH SPECIAL REGARD TO TREE REGENERATION	80
IV B	DECAY AND VEGETATION SUCCESSION MODEL	113
IV C	TREE REGENERATION MODEL 'REGSNAG'	157
V	DISCUSSION AND CONCLUSIONS.....	203
V A	THE MODEL 'REGSNAG'	203
V B	PROTECTIVE EFFECT OF SNAG STANDS OVER TIME	204
V C	CONCLUSIONS	210
VI	REFERENCES OF CHAPTERS I, II, IV A AND V.....	211
VII	APPENDIX	222
VII A	MICROSITE TYPES	222
VII B	SHORT DESCRIPTION OF THE SIMULATION MODEL 'REGSNAG'	225
VII C	SHORT DESCRIPTION OF THE DECAY AND VEGETATION SUCCESSION MODEL	236

Extended contents

<i>Abstract</i>	7
<i>Zusammenfassung</i>	9
I INTRODUCTION	11
I A MOUNTAIN FORESTS AND PROTECTION AGAINST NATURAL HAZARDS	11
1. <i>Natural hazards and protection forests</i>	12
1.1 Protective effects of green stands	13
1.1.1 Rockfall	13
1.1.2 Snow avalanches.....	14
1.2 Protective effects of windthrown and beetle-infested stands	15
2. <i>Tree regeneration in mountain forests</i>	17
2.1 Favourable microsites	17
2.2 Time required until young trees provide protection.....	18
2.3 Target values for tree regeneration in protection forests	19
2.4 Tree regeneration in disturbed sites	21
I B MOTIVATION AND OBJECTIVES OF THE STUDY	22
I C STUDY OVERVIEW	25
II MATERIAL AND METHODS	26
II A STUDY SITE GANDBERG	26
1. <i>Location, topography, geology and climate</i>	26
2. <i>The wildlife reserve 'Freiberg Kärf'</i>	29
3. <i>Forest structure</i>	30
4. <i>Storms and bark beetles</i>	30
II B OVERVIEW OF THE FIELD SURVEYS.....	33
1. <i>Objectives of field surveys</i>	33
2. <i>Sampling methods</i>	34
2.1 Long strip transects.....	34
2.2 Permanent plots	35
2.3 Lines and surrounding strip transects	36
2.4 Randomly sampled tree regeneration	39
III SHORT-TERM SUCCESSION	40
III A DECAY PROCESS.....	40
<i>Decay of Picea abies snag stands on steep mountain slopes</i>	41
1. <i>Introduction</i>	41
2. <i>Materials and methods</i>	43
2.1 Study site	43
2.2 Field sampling and analysis.....	43
2.2.1 Callipering in strip transects	43
2.2.2 Line-intersect sampling.....	44
3. <i>Results</i>	44
3.1 Growing stock.....	44
3.2 Number of broken snags	46
3.3 Height of broken snags	46
3.4 Orientation of logs	46
3.5 Ground contact of logs.....	48
3.6 Nurse logs.....	49
4. <i>Discussion</i>	49
4.1 Growing stock.....	49
4.2 Breakage of snags.....	49
4.3 Orientation and height of logs	50
4.4 Protective effect of the stands.....	50
5. <i>References</i>	51

III B	DEVELOPMENT OF GROUND VEGETATION.....	54
	<i>Bark influence on vegetation development in a dead Picea abies mountain forest</i>	55
	1. <i>Introduction</i>	55
	2. <i>Materials and Methods</i>	56
	2.1 Study site.....	56
	2.2 Methods.....	56
	3. <i>Results</i>	57
	4. <i>Discussion</i>	60
	5. <i>References</i>	61
III C	DEVELOPMENT OF TREE REGENERATION.....	63
	<i>Tree regeneration in a Norway spruce snag stand after tree die-back caused by Ips typographus</i> ... 64	
	1. <i>Introduction</i>	65
	2. <i>Materials and Methods</i>	66
	2.1 Study site.....	66
	2.2 Stand structure.....	66
	2.3 Methods.....	67
	3. <i>Results</i>	68
	3.1 Natural tree regeneration.....	68
	3.2 Sowing experiment.....	71
	4. <i>Discussion</i>	72
	4.1 Development of the snag stand.....	72
	4.2 High mortality rates.....	73
	5. <i>Conclusion</i>	74
	6. <i>References</i>	75
IV	LONG-TERM SUCCESSION	80
IV A	REVIEW OF FOREST SUCCESSION MODELS WITH SPECIAL REGARD TO TREE REGENERATION	80
	1. <i>Overview of forest succession models</i>	81
	1.1 Gap models and hybrid models.....	82
	1.1.1 Gap models.....	82
	1.1.2 Hybrid models.....	86
	1.2 Size class models.....	87
	1.2.1 Discrete approach based on transition matrices.....	87
	1.2.2 Discrete approach with continuous growth functions within each class.....	92
	1.3 Forest management simulators.....	94
	2. <i>Requirements for a model of tree regeneration in the Gandberg snag stands</i>	97
	3. <i>Assessment of existing tree regeneration models with respect to modelling the Gandberg snag stands</i>	100
	3.1 General considerations.....	100
	3.2 Gap models.....	102
	3.3 Size class models.....	105
	3.3.1 Discrete approach based on transition matrices.....	105
	3.3.2 Discrete approach with continuous growth functions within each class.....	107
	3.4 Forest management simulators.....	108
	4. <i>Selection of a model approach</i>	109
IV B	DECAY AND VEGETATION SUCCESSION MODEL	113
	<i>Predicting decay and vegetation development in Picea abies snag stands</i>	114
	1. <i>Introduction</i>	115
	2. <i>Study site</i>	117
	3. <i>Methods for field sampling</i>	118
	3.1 Field data for model initialisation and parameterisation.....	118
	3.1.1 Permanent plots.....	118
	3.1.2 Strip transects.....	119
	3.2 Sampling for model validation.....	120
	4. <i>Model description</i>	121
	4.1 General model description.....	121
	4.2 Model initialisation.....	123
	4.2.1 Woody microsite types (montane and subalpine stands).....	123
	4.2.2 Non-woody microsite types on the montane level.....	124
	4.2.3 Non-woody microsite types on the subalpine level.....	126
	4.3 Model parameterisation.....	127

4.3.1	Transition probabilities involving woody microsite types	127
4.3.2	Transition probabilities of non-woody microsite types at the montane level.....	127
4.3.3	Transition probabilities of non-woody microsite types at the subalpine level	130
4.4	Model implementation and simulation experiments	130
5.	<i>Simulation results</i>	131
5.1	Results for the montane level	131
5.1.1	Comparison with estimated microsite frequencies (model verification).....	131
5.2.2	Comparison with independent field data (model validation)	132
5.2	Results for the subalpine level	133
5.2.1	Comparison with estimated microsite frequencies (model verification).....	133
5.2.2	Comparison with independent field data (model validation)	134
5.3	Results for the time course of succession	135
5.3.1	Comparison with permanent plot data	135
5.3.2	Sensitivity analysis	135
5.3.3	Simulations over 25 years.....	136
6.	<i>Discussion</i>	138
6.1	Accuracy of the presented model.....	138
6.2	When to use which model parameter set?.....	139
7.	<i>References</i>	141
8.	<i>Appendix: model parameterisation</i>	147
8.1	Transition probabilities involving woody microsite types.....	147
8.2	Transition probabilities of non-woody microsite types at the montane level	150
8.3	Transition probabilities of non-woody microsite types at the subalpine level.....	154
IV C	TREE REGENERATION MODEL 'REGSNAG'	157
	<i>Predicting tree regeneration in Picea abies snag stands</i>	158
1.	<i>Introduction</i>	159
2.	<i>Study site</i>	160
3.	<i>Description of the model RegSnag</i>	161
3.1	Model structure.....	161
3.1.1	Microsite type module	161
3.1.2	Tree regeneration module	162
3.1.3	Module coupling: tree regeneration in microsites.....	163
3.1.4	Model implementation	165
3.2	Model initialisation.....	166
3.3	Model parameterisation	166
3.3.1	Seed rain, germination and mortality.....	166
3.3.2	Height increment.....	167
3.3.3	Browsing intensity	173
4.	<i>Sampling for model validation</i>	175
5.	<i>Simulation scenarios and sensitivity analysis</i>	175
6.	<i>Simulation results</i>	176
6.1	Short-term simulation compared with independent field data	176
6.1.1	Frequency of <i>Picea abies</i> in each microsite type.....	176
6.1.2	Frequency of tree regeneration in each height class	179
6.1.3	Browsing intensity	184
6.2	Long-term simulations	185
6.2.1	Montane level	185
6.2.2	Subalpine level.....	187
7.	<i>Discussion</i>	189
8.	<i>References</i>	191
9.	<i>Appendix: Details of model parameterisation</i>	196
9.1	<i>Picea abies</i>	196
9.1.1	Seed availability.....	196
9.1.2	Germination	197
9.1.3	Mortality	198
9.1.4	Height increment.....	199
9.2	<i>Betula pendula</i>	200
9.2.1	Seed availability.....	200
9.2.2	Germination	200
9.2.3	Mortality	200
9.2.4	Height increment.....	201
9.3	<i>Sorbus aucuparia</i>	201
9.4	<i>Acer pseudoplatanus</i>	202

V	DISCUSSION AND CONCLUSIONS.....	203
V A	THE MODEL ‘REGSNAG’	203
V B	PROTECTIVE EFFECT OF SNAG STANDS OVER TIME	204
1.	<i>Protection provided by snags, stumps and logs</i>	204
2.	<i>Density and size of tree regeneration</i>	206
3.	<i>Spatial distribution of tree regeneration</i>	208
V C	CONCLUSIONS	210
VI	REFERENCES OF CHAPTERS I, II, IV A AND V.....	211
VII	APPENDIX.....	222
VII A	MICROSITE TYPES	222
VII B	SHORT DESCRIPTION OF THE SIMULATION MODEL ‘REGSNAG’	225
VII C	SHORT DESCRIPTION OF THE DECAY AND VEGETATION SUCCESSION MODEL	236
	<i>Curriculum vitae</i>	237

Acknowledgements

Let me express my gratitude mainly to the following persons:

- Prof. Dr. Harald Bugmann, leader of the Mountain Forest Ecology group of the Department of Forest Sciences at the Swiss Federal Institute of Technology in Zürich, Dr. Walter Schönenberger and Dr. Peter Brang of the Section Silvicultural Strategies of the Swiss Federal Research Institute WSL in Birmensdorf for initiating this project and all their support, helpful suggestions, careful manuscript reviews, and particularly for their continuous interest in my work
- other members of the WSL who (i) helped during field work, e.g. Ulrich Wasem and Marc Battaglia, (ii) gave advice during the modelling work, e.g. Dr. Heike Lischke, or (iii) simply enriched my nice time at the WSL in Birmensdorf
- Stefan Landolt who sampled with me the data about snag decay. I am indebted to him for leaving me all the data of his diploma work
- the forest service of Schwanden, in particular the forester Adolf Tschudi, for their logistical help during the field work
- the members of the forest office in Glarus, in particular Jürg Walcher and Thomas Rageth, for their collaboration
- the members of the Seminar of Applied Statistics at the Swiss Federal Institute of Technology in Zürich for their helpful statistical discussions

- my family who made my studies possible
- and Massimo Albisetti who became my husband during this PhD thesis

This work was supported by the Foundation for the Advancement of Forest and Wood Research, the government of the canton Glarus and the Swiss Federal Research Institute WSL.

Abstract

The storm 'Vivian' in February 1990 struck large parts of Western Europe and downed $4.9 \cdot 10^6$ m³ of timber in Switzerland. The resulting breeding material triggered bark beetle (*Ips typographus* L.) infestations, which caused the die-back of many Norway spruce (*Picea abies* (L.) Karst.) stands, including protection forests on steep slopes. Little was known about the development of the resulting snag stands in the Swiss Alps. Particularly, it was unknown how snag decay, ground vegetation and the tree regeneration would develop. The main questions of this PhD thesis were therefore:

- How long do snags, stumps and logs provide effective protection against natural hazards such as rockfall and snow avalanches?
- How fast will *Picea abies* saplings and the regeneration of other tree species develop in a snag stand and build a new protection forest?

A combination of field studies and dynamic modelling was used to answer these questions. The Gandberg forest in the Swiss Alps, where *Picea* trees had been killed by bark beetles on an area of ca. 30 ha, was selected as a case study. These steep snag stands are a potential area of rockfall and snow avalanche release, but they are not classified as a forest with direct protection function because no village or other human infrastructure is located downslope. The field surveys were used to describe short-term succession, and with a new mathematical model the long-term development of the snag stands on the Gandberg was projected. Particular emphasis was placed on modelling the density and height of tree regeneration.

Since 1994, the ground-vegetation and tree-regeneration development had been studied annually on 24 permanent plots (1 m x 1 m). In 2000, microsite types were quantified along 4 strip transects (5 m x 100-160 m) on the montane (1200-1450 m a.s.l.) and subalpine (1450-1600 m. a.s.l.) levels of the Gandberg forest, and snag decay was studied using full-callipering within these strip transects. In addition, the height of lying logs above ground level was studied in 2001 using the line intersect method along 128 lines that had a length of 10 m.

None of the dead trees had been uprooted, but 75% were broken in 2000. On average, logs were at a distance of 85 cm above the soil surface in 2001. The orientation of the logs could be explained with the prevailing wind direction even on this steep slope. These results and a comparison with windthrow areas suggest that unharvested *Picea abies* snag stands on such steep slopes provide effective protection against rockfall and avalanche release for about 30 years.

The ground vegetation of the *Galio-Abieti-Piceetum* association on the montane level changed into a *Rubus idaeus* brushwood during the first years after *Picea* die-back. In contrast, ferns, *Calamagrostis villosa* and *Polytrichum formosum* still dominated the former *Homogyno-Piceetum vaccinietosum myrtilli* association at the subalpine level.

No advance tree regeneration was present after tree death. Three *Picea abies* seedlings m⁻² germinated in 1994, originating from natural regeneration. However, their mortality amounted to about 25% each year, regardless of their age (1-7 years), probably because of the increasing impact of competing ground vegetation. In 2001, *Acer pseudoplatanus* saplings were almost as numerous as *Picea* (0.58 m⁻²), but *Betula pendula* (0.29 m⁻²), *Sorbus aucuparia* (0.16 m⁻²) and *Salix caprea* (0.04 m⁻²) were rare. Tree saplings were still very small in 2001 (ca. 15 cm tall), except some infrequent birch trees (ca. 2 m).

A new simulation model 'RegSnag' was developed. It simulates the establishment of 4 tree species (*Picea abies*, *Betula pendula*, *Acer pseudoplatanus* and *Sorbus aucuparia*) with 8 height classes (<10 cm, 10.1-20, 20.1-40, 40.1-70, 70.1-130, 130.1-250, 250.1-500, >500 cm) on 26 microsite types (e.g. moss on boulders, coarse woody debris, *Rubus* brushwood). As these microsite types change over time, snag decay and ground-vegetation development were modelled using a modified matrix model approach. Model parameters were estimated based on data from the field surveys and from the literature. For model validation, microsite types were quantified in 2001 using the line-intercept method along the 128 10-m long lines on both elevational levels, and tree regeneration was counted in 2-m wide strip transects around these lines.

Simulation runs showed that on both the montane and the subalpine level the microsite frequencies and the amount and height of tree saplings during the first eight years after tree die-back were simulated accurately, starting from the conditions in the stands before the bark beetle attack. Model predictions of the frequency and height of tree regeneration were closest to those observed in the field when the rates of germination, height growth and mortality were estimated separately for each microsite type. Moreover, the density and height of trees strongly depended on seed availability and browsing intensities.

According to the model simulations, *Picea* and not *Betula*, *Sorbus* or *Acer* trees will replace the current vegetation in these snag stands. Furthermore, only about 330 *Picea* saplings ha⁻¹ out of those that germinated in 1994 and 1996 will probably reach the height of 5 m about 35 years after *Picea* die-back on the montane level of the Gandberg. This is due to the high browsing pressure. On the subalpine level, in contrast, about 930 *Picea* saplings ha⁻¹ will reach the height of 5 m after 30 years, which is likely to be sufficient for providing effective protection against snow avalanches and probably also against rockfall. The simulations on the development of the trees together with the investigations on snag decay and the height of logs suggest that the protective effect will first be maintained by the snags, stumps and logs, then by both the dead wood and the new *Picea* regeneration, and finally by the new *Picea* trees. Thus I conclude that leaving a snag stand uncleared on a steep slope will maintain effective protection for several decades, provided that the browsing pressure is not too high. Therefore this strategy is a valid management option.

Zusammenfassung

Der Sturm 'Vivian' vom Februar 1990 traf weite Teile von Westeuropa und warf rund 4.9 Mio. m³ Holz im Schweizer Wald. Das viele liegen gebliebene Holz bot gutes Brutmaterial für den Buchdrucker (*Ips typographus*) und führte zu einer Buchdrucker-Massenvermehrung in Fichtenwäldern (*Picea abies* (L.) Karst.). Man wusste aber nur wenig über die Entwicklung des Baumzerfalls, der Bodenvegetation und der Baumverjüngung in Totholzbeständen. Es stellten sich deshalb die folgenden zwei Fragen:

- Wie lange können stehende tote Bäume, Strünke und Baumstämme vor Naturgefahren wie Waldlawinen und Steinschlägen schützen?
- Wie entwickelt sich die Baumverjüngung in solchen Totholzbeständen, und wie lange dauert es, bis ein schutzwirksamer Wald herangewachsen ist?

Für die Beantwortung dieser Fragen wurden Felduntersuchungen und dynamische Modellierung genutzt. Als Studienobjekt wurden die Totholzbestände im Gandbergwald, Kanton Glarus, gewählt (ca. 30 ha). Dieser steile Gebirgshang ist ein potenzielles Anrissgebiet von Steinschlägen und Waldlawinen. Er hat jedoch keine direkte Schutzfunktion, da keine Dörfer oder andere Infrastrukturanlagen unterhalb des Waldes liegen. Anhand von Felderhebungen wurde die Entwicklung der Totholzbestände in den ersten 8 Jahren nach dem Absterben der Fichten untersucht, und mit einem neu entwickelten Modell wurde die zukünftige Bestandesentwicklung simuliert.

Seit 1994 war die Deckung der Vegetation und die Dichte der natürlichen Baumverjüngung jährlich in 24 1 m x 1 m grossen Dauerflächen aufgenommen worden. Zusätzlich wurde im Jahre 2000 entlang von 4 horizontalen Streifentransekten (5 m breit und 100-160 m lang) in der montanen (1200-1450 m ü.M.) und subalpinen (1450-1600 m ü.M.) Höhenstufe die Häufigkeit von Kleinstandortstypen geschätzt. Mittels Vollkluppierung wurden die stehenden toten Bäume, die Strünke und das liegende Holz ebenfalls in diesen Streifentransekten vermessen. Die Distanz der liegenden Baumstämme zum Boden wurde im Jahre 2001 an Schnittpunkten mit 128 Linien von je 10 m Länge gemessen.

Im Sommer 2000 waren 75% der toten Bäume gebrochen, aber keine waren entwurzelt worden. Die Baumstämme befanden sich durchschnittlich 85 cm über dem Boden und waren ineinander verkeilt. Die Fallrichtung der toten Bäume konnte auch an diesem steilen Hang mit den vorherrschenden Windrichtungen erklärt werden. Aufgrund dieser Resultate und einem Vergleich mit Windwurfflächen ergab sich, dass die liegenden Stämme und Strünke während ca. 30 Jahren vor Naturgefahren schützen dürften.

In der montanen Höhenstufe entwickelte sich die Bodenvegetation des Labkraut-Tannen-Fichtenwaldes in den ersten Jahren nach dem Absterben der Fichten zu einem üppigen Himbeergestrüpp. In der subalpinen Höhenstufe dominierten hingegen weiterhin Farne, *Calamagrostis villosa* und *Polytrichum formosum* die Bodenvegetation der Assoziation Alpenlattich-Fichtenwald mit Heidelbeere.

In den Beständen war keine Vorverjüngung vorhanden. Rund 3 Fichten m⁻² keimten im Jahre 1994. Die jährliche Mortalitätsrate dieser natürlichen Fichtensämlinge und des Anwuchses lag konstant bei ungefähr 25%, wahrscheinlich infolge der zunehmenden

Konkurrenz durch Bodenvegetation. Im Jahr 2001 war fast gleich viel Verjüngung von *Acer pseudoplatanus* (0.58 m^{-2}) vorhanden wie Fichten, dagegen waren *Betula pendula* (0.29 m^{-2}), *Sorbus aucuparia* (0.16 m^{-2}) und *Salix caprea* (0.04 m^{-2}) selten. Die Baumverjüngung war noch sehr klein (ca. 15 cm hoch), mit Ausnahme einiger Birken (ca. 2 m).

Ein neues Modell der Wiederbewaldung von Totholzbeständen („RegSnag“) wurde entwickelt. Das Modell simuliert die jährliche Dichte und die Höhe der 4 Baumarten Fichte, Birke, Vogelbeere und Bergahorn mit Hilfe von 8 Höhenklassen (<10 cm, 10.1-20, 20.1-40, 40.1-70, 70.1-130, 130.1-250, 250.1-500, >500 cm) verteilt auf 26 Kleinstandortstypen (z.B. Himbeergestrüpp, Moderholz, mit Moosen bewachsener Blockschutt). Da sich im Laufe der Sukzession die Häufigkeit der Kleinstandortstypen ändert, umfasst das Modell nicht nur die Baumverjüngung, sondern auch die Zerfallsdynamik und die Vegetationsentwicklung (modifiziertes Matrizen-Modell). Die Modellparameter wurden mit Hilfe der Resultate aus den Felderhebungen sowie anhand von Werten aus der Literatur geschätzt. Für die Modellvalidierung wurde die Häufigkeit der Kleinstandorte im Jahre 2001 entlang der 128 Linien aufgenommen („Linien-Abschnitt-Methode“), und die Baumverjüngung wurde in 2 m breiten Streifentransekten um diese Linien herum gezählt.

Ausgehend vom Bestand vor dem Buchdruckerbefall konnte mit Hilfe des Modells die Häufigkeit der Kleinstandortstypen, sowie die Dichte und Höhe der Baumverjüngung während den ersten 8 Jahren nach dem Absterben der Fichten, gut simuliert werden. Die im Feld beobachteten Verjüngungsdichten und gemessenen Höhen wurden bei den Simulationen dann am genauesten abgebildet, wenn Keimungs-, Wachstums- und Mortalitätsraten im Modell kleinstandortspezifisch geschätzt waren. Die Verfügbarkeit von Samen und der Wildverbiss beeinflussten Dichte und Höhe der Baumverjüngung stark.

Langzeitsimulationen ergaben, dass Fichten die heutige Vegetation ablösen werden und nicht Birken, Vogelbeeren oder Bergahorne. Von den Fichten, die im Jahre 1994 und 1996 gekeimt waren, erreichen laut Modellberechnungen in der montanen Höhenstufe nur ca. 330 Stück ha^{-1} nach rund 35 Jahren eine Höhe von 5 m. Dies ist bedingt durch den sehr hohen Wildverbiss. In der subalpinen Stufe erreichen dagegen ca. 930 Fichten ha^{-1} nach 30 Jahren eine Höhe von 5 m. Diese Dichte dürfte für einen effizienten Schutz vor Lawinenanrissen und eventuell auch vor Steinschlag genügen. Die Simulationsergebnisse deuten zusammen mit den Resultaten des Totholzerfalls darauf hin, dass die Schutzwirkung des Gandbergwaldes zuerst durch die Strünke und liegenden Stämme gewährleistet wird, danach durch das Totholz und die aufkommenden Fichten und später nur noch durch die neuen Fichten. Die Studie zeigt, dass ungeräumte Totholzbestände in steilen Gebirgslagen über mehrere Jahrzehnte vor Naturgefahren schützen können, sofern der Wildverbiss nicht zu hoch ist. Das Belassen von Totholzbeständen ist deshalb eine prüfungswürdige Management-Option.

I INTRODUCTION

I A Mountain forests and protection against natural hazards

Mountain regions make up about one-fourth of the Earth's land surface (Kapos *et al.* 2000). In the European Alps, the term 'mountain forest' generally refers to forests between ca. 600-800 m a.s.l. and the treeline, which is located at 1600-2400 m a.s.l. (Mayer and Ott 1991). They include montane and subalpine forest ecosystems. The boundary between these two broad forest types is usually between 1200 and 1600 m a.s.l. (Ott *et al.* 1997). Around 55% of the mountain forests are dominated by Norway spruce (*Picea abies* (L.) Karst.) in the Swiss Pre-Alps and Alps (Brassel and Brändli 1999). The higher the altitude of *Picea abies* forests in the European Alps, the more the stands are characterised by a mosaic structure of so-called 'Rotten' collectives, i.e. clusters of trees (Schönenberger 2001).

Until the 19th century, European mountain forests have been heavily exploited commercially for timber. Large-scale clear cuts were common. In steep mountain forests, this practice led to an increase in erosion and thus negatively affected slope stability. Over the years mountain people realised that forests are not only a timber resource, but are also important for protecting people, settlements, traffic routes, etc. against natural hazards. In the 19th century, it was therefore regulated by law for large parts of the Swiss Alps that clear cut areas had to be afforested (e.g. Forstverwaltung Kt. Glarus 1949, KÜchli and Baumgartner 2001). This was mostly done with *Picea abies*. The simultaneous planting of one tree species together with the emergence of natural tree regeneration in the first years after clear cutting often led to homogeneous, dense, single-species forests (cf. Wasser and Frehner 1996). These *Picea abies* stands are characterised by high intraspecific competition, short crowns, and similar tree age and height. In particular, the dense stands of trees with tall stems and short crowns at the montane level are quite susceptible to storm damage (Rottmann 1985, Dobbertin 2002), bark beetle infestations and snow break (cf. Brang *et al.* 2001). Furthermore, these stands often are so dense today that they impede tree regeneration (Brang and Duc 2002). Restocking in such mountain forests takes therefore mainly place after the breakdown of the old stands or after disturbances (cf. Leibundgut 1984).

1. Natural hazards and protection forests

Protection forests have a protective effect, that means they prevent or mitigate damage that natural hazards or adverse climate would otherwise cause to people or assets (Brang *et al.* 2001). On the basis of the potential damage to people or assets, protection forests in Switzerland are classified as ‘protection forests with direct protection function’ and ‘other protection forests’ (Schweizerische Waldverordnung of 30. November 1992, Art 42, Absatz 2). According to the second National Forest Inventory (LFI), about 8-20% of the forested area in the Swiss Alps provide protection against avalanches and/or rockfall (Brändli and Herold 1999). In mountain regions, 16% of the plots recorded in the LFI exhibited evidence of erosion, 37% of moving snow and 31% of rockfall (Mahrer *et al.* 1988).

To ensure the protective effect of these forested areas over time, larger clear cuts of intact forest are forbidden in protection forests since 1902 ('Swiss federal forest law' = Eidgenössisches Forstgesetz). Nowadays, a minimum maintenance of forests which provide protection has to be ensured by the cantons. The main objective of forest management in such protection forests is to reduce the risk of forest breakdowns and die-backs by enhancing resistance and resilience. Thereby, the produced timber may be harvested, and it is sometimes used in the same stands for construction (e.g. avalanche barriers) or left unused in the forest. Of course, the latter can only be made if the logs are not a risk themselves since they could move downslope.

In the past decades, salvage logging after natural disturbances was the most common practice in Swiss mountain forests. About half of all harvesting activities in Swiss mountain forests over the last three decades took place after forest breakdowns, caused by windthrow or insect attacks (Brassel and Brändli 1999). Salvage logging was so frequent because forest practices in the 19th and first half of 20th century led to rather dense *Picea abies* forests which have become susceptible to natural disturbances, as mentioned above. A much more resistant forest structure would be a small-scale mosaic of all classes of tree size and age, the so-called 'selection forest' (e.g. Ott 1996). Current management practices are aimed at facilitating the development of this desired forest structure (e.g. Wasser and Frehner 1996).

1.1 Protective effects of green stands

A forest cannot prevent avalanches, rockfall etc. with absolute certainty. Nevertheless, the incidence and magnitude of such events is lower under forest cover than under any other natural land cover or land use (e.g. Rickli 2000).

At a given site, the natural hazards determine the minimum requirements for the structure of a stand to ensure permanent protection.

1.1.1 Rockfall

The protective ability of a forest is mainly determined by the number and sizes of the trees. The stems of living or dead trees can stop falling stones (Cattiau *et al.* 1995, Dorren *et al.* 2003), and an appropriate number and size of trees, given a certain typical diameter of the falling rocks, may entirely prevent the passage of stones across the stand. The minimum requirements with respect to stem density and their size distribution within a stand to provide effective protection (i.e. line indicating threshold of effective protection in Fig. 1) have not been defined well to date (Chauvin *et al.* 1994). According to the Second Swiss National Forest Inventory (Brändli and Herold 1999), stands with a stand density index ($SDI = \text{stem density} * (\frac{25}{\text{mean dbh}})^{-1.6}$) larger than about 800 generally have good effects against rockfall. In a revised version of the “Minimale Pflegemassnahmen für Wälder mit Schutzfunktion” (Wasser and Frehner, in prep.) the following forest structure is recommended:

- at least 400 stems ha^{-1} with dbh >12 cm if the stones have a diameter < 40 cm
- at least 300 stems ha^{-1} with dbh >24 cm if the stones have a diameter of 40–60 cm
- at least 150 stems ha^{-1} with dbh >36 cm if the stones have a diameter of 60–180 cm.

This is in broad agreement with the general rule that the effective target dbh of a forest to protect against rockfall should be 1/3 of the decisive size of the falling stones (Schweizerische Gebirgswaldpflegegruppe 1998). It is clear that further studies need to be conducted to define the minimum demands for the structure of forests that are to protect against rockfall.

It is evident that dense stands with only small tree-free gaps parallel to the slope are highly effective in preventing rockfall hazard (Gsteiger 1990, Cattiau *et al.* 1995). Unfortunately, very dense stands are probably not the best solution for effective long-term protection, as they are usually susceptible to storm damage and do not allow for sufficient regeneration. In protection forests, a continuous renewal of the tree canopy is crucial since this ensures a continuous forest cover in the long-term. Forests with early pole stages (i.e. coppice, low forests) or mountain selection forests are generally assumed to provide good protection (Gsteiger 1990, Baumgartner 2002).

1.1.2 Snow avalanches

The build-up of a homogenous snow layer that may glide as a compact blanket can be prevented by tree crowns, as snow is intercepted by the forest canopy. When this snow drops to the ground as snow clumps or melt-water, it prevents the formation of mechanically weak snow layers, which are a prerequisite for avalanche formation in forests (Bründl *et al.* 1999a, Bründl *et al.* 1999b).

Gap size requirements for protection against snow avalanches are probably similar to those against rockfall, but stand density is less important (e.g. Meyer-Grass 1985). In closed conifer stands, avalanche formation is very rare because uniform snow layers are not formed and snow density is relatively high (Meyer-Grass and Imbeck 1985, Mössmer *et al.* 1990). In forest gaps, small-scale avalanches can occur, as reduced interception leads to the formation of more uniform snow layers, and snow density tends to be lower. According to several studies (Meyer-Grass and Schneebeli 1992, Kaltenbrunner 1993, Bebi 2000), avalanches are to be expected in forested areas when all of the following critical stand conditions are fulfilled:

- crown cover less than 35%
- less than 190 trees ha⁻¹ (dbh > 16 cm)
- tree-free gaps larger than 10-15 m in downward slope direction (measured from crown edge to crown edge)
- a slope inclination of more than about 35°

Some of these critical stand conditions are correlated, and a change of slope inclination of more than 5° may reduce the critical slope inclination or gap length. Furthermore, trees generally contribute against the release of avalanches if they are higher than twice the maximum snow height (e.g. Meyer-Grass 1985). In a revised version of the “Minimale Pflegemassnahmen für Wälder mit Schutzfunktion” (Wasser and Frehner, in prep.) the authors therefore recommend:

- 500 trees ha⁻¹ larger than 8 cm dbh if the slope angle is about 30°
- 1000 trees ha⁻¹ larger than 8 cm dbh if the slope angle is about 40°.

However in avalanche zones, successful tree regeneration may collapse completely due to snow movements when the trees reach a stem diameter of more than 10 cm and have therefore lost their elasticity (see e.g. discussion in Schönenberger 2001).

To conclude, coniferous stands with only small treeless distances parallel to the slopes (< 15 m) and with about 500-1000 trees taller than twice the height of the average maximum snow height, are supposed to be effective in minimising the risk of snow avalanches.

1.2 Protective effects of windthrown and beetle-infested stands

Stand destruction by storms does not imply an immediate loss of the protective effect. In contrary, during about the first 10 years, broken trees, logs and treefall mounds act as barriers for snow movements (which could trigger avalanches) and enhance surface roughness (Frey *et al.* 1995). Therefore, the protection provided against avalanches and rockfall is similar or even higher compared to that of an intact green forest for a few years following windthrow (Fig. 1, brown curve). During the following decades, the logs subside and begin to decompose. The protective effect of logs therefore gradually declines over time (Fig. 1, brown curve). More details about the importance of the height, the distribution and the orientation of logs for effective protection are given in chapter III A. According to Frey and Thee (2002), it takes about 30 years until the snapped trees and logs in a windthrow area lose their protective effect. In contrast, the protective effect of new trees increases over time (Fig. 1, green curve). A potentially critical phase may occur when the stumps and logs lose their protective effect before new protection is provided by the tree regeneration (Fig. 1, cf. discussion in Brang and Lässig 2000).

Compared to the persistence and resilience of green *Picea abies* forests and windthrow areas, little is known about the persistence of dead trees or even of whole snag stands (i.e. stands of dead standing trees, see chapter III A). Generally, there is a lack of knowledge about the decay process of snag stands in European mountain forests and their effectiveness in protecting against natural hazards (see chapter III A).

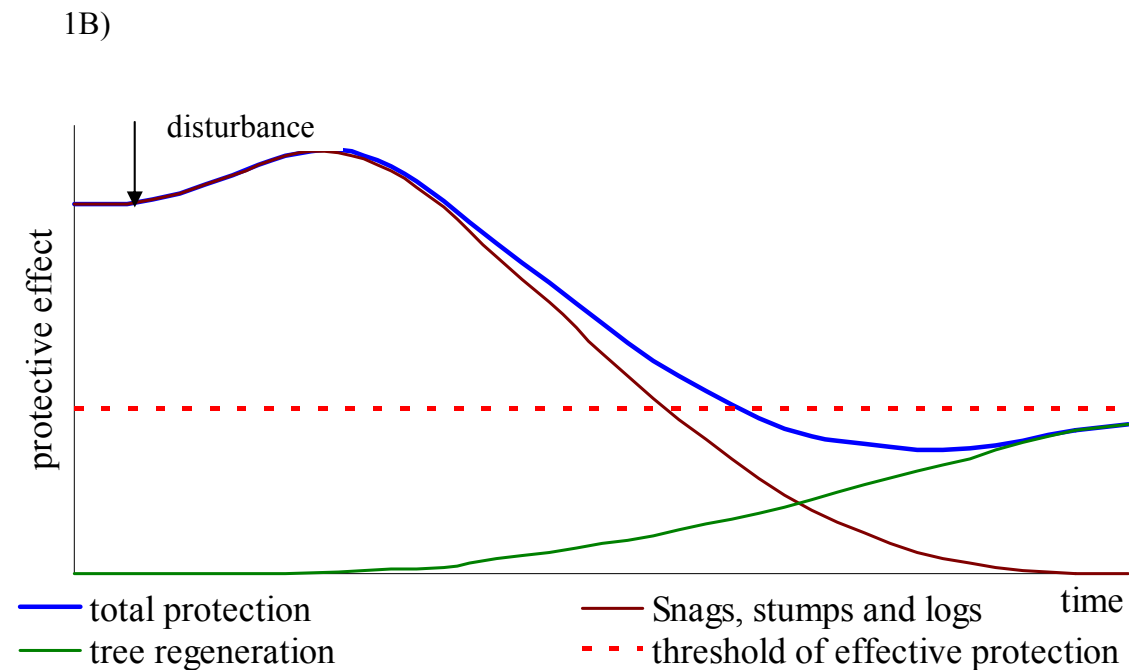
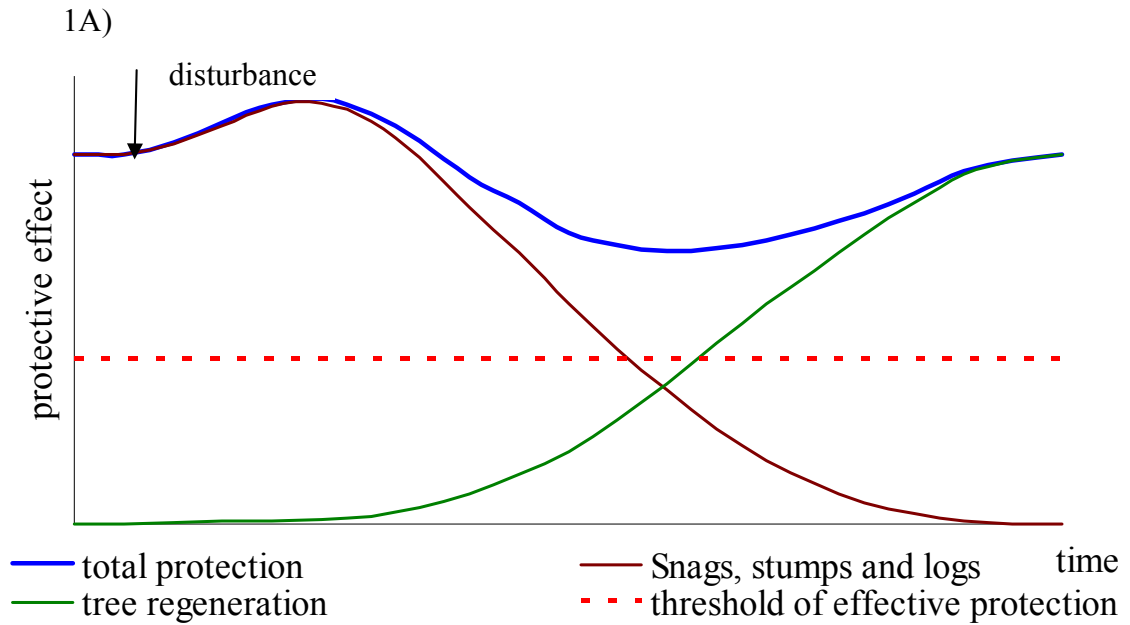

Fig. 1: Schematic representation of the development of the protective effect of a stand after disturbance. The total protective effect of a stand (blue curve) can be divided into the protective effect of (i) the decaying stand (brown curve) and (ii) the natural tree regeneration (green curve). In the lower panel (B), total protection is below a particular threshold during a certain period (see section 1.1.1 and 1.1.2 of this chapter for thresholds of minimum protection in green stands), therefore the stand cannot effectively impede natural hazards for that period. (The figure is based on Brang and Lässig 2000).

2. Tree regeneration in mountain forests

2.1 Favourable microsites

With increasing altitude, tree growth decreases as a consequence of adverse climatic impacts, e.g. low temperature (e.g. Lüscher 1990). Direct radiation becomes crucial for most tree species, including *Picea abies* in high-elevation Norway spruce forests (Brang 1997). In such forests, concave and convex terrain forms are experiencing large differences in radiation, snow cover, and soil moisture and are therefore not equally suitable for tree regeneration. When a microsite is characterised by a set of environmental conditions that meet the demands of a given tree species for establishment and growth, this site is referred to as a ‘favourable’ microsite (corresponding to a ‘safe’ site as defined by Harper *et al.* 1965).

In general, the following sites are assumed to be favourable for *Picea abies* regeneration (according to e.g. Schönenberger 1975, Leibundgut 1984, Imbeck and Ott 1987, Schönenberger and Rüschi 1990, Mayer and Ott 1991, Brang 1997, Camaret 1997, Senn 1999, Frehner 2000, Schönenberger 2001, Hunziker and Brang submitted):

- locally elevated terrain such as ridges, shoulders, rocks, rotten wood and tree stumps
- microsites with sufficient direct sunlight
- microsites without vegetation or at least with only sparse vegetation cover (naturally this depends on the species, i.e. *Sorbus* does not seem to prevent *Picea* regeneration (Hillebrand and Leder 1995))
- microsites with early snowmelt, for example around stumps or generally where there is little snow cover
- microsites with exposed mineral soil.

In contrast, the following sites are assumed to be unfavourable for *Picea abies* regeneration:

- microsites with a long duration of snow cover, especially because of snow mould (mainly *Herpotrichia sp.* in the case of *Picea abies*)
- microsites in depressions or, more generally, all cold microsites (e.g. slopes with northern aspect), due to a lack of solar energy
- microsites with snow movements
- microsites with thick layers of raw humus
- microsites with dense competing ground vegetation, mostly because tree seedlings and saplings suffer from a lack of light.
- very moist sites
- sites with very high winds and risk of winter desiccation.

For example, in mountain forests that are dominated by *Vaccinium myrtillus* or *Calamagrostis*, tree regeneration is found almost exclusively on elevated sites that have a higher incident radiation, which are warmer and therefore covered by snow for a shorter time, particularly in spring (cf. discussion in Leibundgut 1984). According to Schönenberger (2001), the rougher the topography of a mountain forest, the larger is the proportion of such favourable microsites. Generally, microsites are more important on the subalpine than on the montane elevational level because of the rougher climate. A consequence of these favourable and unfavourable microsites is a clumpy stand structure which is characteristic for many high-elevation forests (see e.g. discussion in Brang 1998).

However, tree regeneration is not only limited spatially by favourable microsites, but also temporally, due to irregular seed availability. Seed production per tree is generally lower at higher altitudes compared to lowlands (Mayer and Ott 1991, Mencuccini *et al.* 1995) because years with high seed production (i.e. mast years = episodic, synchronised high seed production) become rarer (Mencuccini *et al.* 1995).

A more detailed review about the influence of microsites with different vegetation cover on tree regeneration in mountain forests is given in chapter IV C.

2.2 Time required until young trees provide protection

Successional cycles are long in high-elevation forests because tree regeneration is a slow process in mountain regions. It is not easy to state how long it takes a tree to reach the height and dbh sufficient to effectively protect against snow avalanches or rockfall. That means, how long it takes until a tree sapling can be considered as a part of the protective regeneration (i.e. 'schutzfähige Verjüngung' (Ott 1989), green line above the critical limit in Fig. 1). Lüscher (1990) determined the age of 5 m high *Picea abies* and obtained between 35-105 years at the subalpine level and 25-85 years at the montane level. Mayer and Ott (1991) and Ott *et al.* (1997) quote about 50 to 80 years until tree regeneration in the subalpine level reaches the status of a protective regeneration. In the revised version of the „Minimale Pflegemassnahmen für Wälder mit Schutzfunktionen“ (Wasser and Frehner, in prep.), the time until trees have grown from a height of 40 cm to a dbh of 12 cm is estimated with 50 years for subalpine and 25 years for montane forests. Brang and Duc (2002) estimated for small gaps, based on a literature review, the time tree regeneration needs in subalpine and high montane *Picea* forests to pass from 0 to 10 cm height with 10 years, from 0 to 5 m with 68 years, and from 0 m height to 12 cm dbh with 100 years. However, browsing and fraying of ungulates on tree shoots may slow down the tree growth process. To make detailed estimates of the course of tree height growth on a specific site, it is probably best to model the height of tree regeneration over time, because with such a model approach

different assumptions (e.g. regarding ungulate and pathogen effects) can be incorporated in different simulation scenarios.

2.3 Target values for tree regeneration in protection forests

As many trees die before reaching the height and dbh sufficient to provide effective protection against snow avalanches or rockfall, it is even more difficult to determine how many tree seedlings and saplings are needed to fulfil the minimum requirements (listed in section 1.1 of this chapter) in the future when they are tall enough to provide protection. Such target values of minimum numbers of tree regeneration have been given by several authors (Table 1).

These target values range from about 1'000 to 4'500 tree saplings ha⁻¹ (except for the high value of > 8'000 by Mayer and Ott 1991), depending on the height of the young trees, the elevational level and the assumptions made by the various authors (Table 1). Moreover, the variability in the described target values shows that it is difficult to give target values that are generally applicable.

In addition, ungulates have the potential to hinder sapling establishment of all or some tree species, in particular *Abies alba*, *Sorbus aucuparia* and *Acer pseudoplatanus* (cf. Ott *et al.* 1991). Apart from this ungulate problem, pathogens like snow mould (*Herpotrichia sp.*) may kill all tree regeneration in very snow-rich years. These two factors make it more difficult to state accurate target values for particular sites. Again, mathematical models may help us to find improved, though still approximate values.

Table 1: Compilation of literature data on target values for tree regeneration in montane (m) and subalpine (s) *Picea abies* or *Picea abies*-*Abies alba* forests.

authors	level	tree height	number / ha	remarks
Schodterer (1998)	s	young trees	> 1'500	
	m	young trees	> 1'750	thereby, > 250 <i>Abies</i> trees
Reimoser (1998)		< 3 m	> 2'000-5'000	depends on the species and forest type
Carmignola <i>et al.</i> (1998)	s	young trees	> 3'000	but at least > 300 unbrowsed <i>Picea</i> that are > knee height
Schönenberger <i>et al.</i> (1990)	s	10-20 cm	> ca. 1'640	structured in clusters and small collectives of ca. 20 trees (Rottenaufforstung)
Brang and Duc (2002)	s	10 cm height to 12 cm dbh	cover > 3-26% of the area	when ca. 65-85% of the total are can be stocked with trees
Wasser and Frehner (1996)	s	40 cm height to 12 cm dbh	80–150 groups	in an intact green forest
	m		1-3 groups	
LFI 1 Mahrer <i>et al.</i> (1988)		30-130 cm (JK 1)	> 4'500	distance between planted trees is 1.5 m
		1.3-2.5 m (JK 2)	> 3'200	according to yield tables of the Eidg. Anstalt für das forstliche Versuchswesen
		2.5-6.5 m (JK 3)	> 1'600	
		6.5-11 m (JK 4)	> 1'000	
Mayer and Ott (1991)	s (tree line)	20-30 cm	8'000-12'000 > 200 groups	calculated with 80% tree mortality. alternative: 1-1.5 kg. seeds ha ⁻¹
	m		6'000-8'000	
Ott <i>et al.</i> (1997)	s	3 years old – 50-80 years	cover > 1/6 – 1/3 of the area ≅ 59 cluster ha ⁻¹ ≅ 1'200-1'800	20-30 saplings per cluster (Rotte)

2.4 Tree regeneration in disturbed sites

Some general problems of tree regeneration in large tree-free gaps and disturbed sites (such as windthrow areas, clear-cuts and snag stands) are to some extent fairly similar to those in other high-elevation forests, for example:

- the limited availability of favourable microsites (cf. section 2.1)
- the high tree mortality (cf. section 2.3)
- and browsing by ungulates (cf. section 2.2 and 2.3).

However, the effect of browsing may even be more pronounced in disturbed sites, as the ground vegetation is growing better than in living stands and therefore the availability of other forage plants is higher, which may attract ungulates (Jehl 1995).

Anyway, disturbed sites differ also from intact green stands because:

- more light is available, which results not only in a lush ground vegetation, but also in a better growth of *Picea* regeneration (e.g. Örländer and Karlsson 2000)
- an increase in nutrients occurs during the first few years after disturbance
- seed availability is limited even more strongly as seeds do not fly far away from the source trees.

Some examples for this seed limitation; Kuoch (1965) found 20 m upside a horizontally running treeline only about 1% of the *Picea* seeds he observed in the mountain forest. Parallel to the contour lines (i.e. horizontal), *Picea* seeds may be spread up to 1000 m from the source trees, but usually the distance is smaller than about twice the height of trees (Lässig *et al.* 1995). Furthermore, the amount of silver birch (*Betula pendula*) seeds declines exponentially with the distance from the seed source (Cameron 1996). The size of disturbed sites is therefore important in determining the amount of seeds which are available during seed years (e.g. Mössnang and Kühnel 1999, Schmidt-Schütz 1999).

The various disturbances differ among each other in their effects on tree regeneration. Regeneration that established prior to disturbance – so called “advance tree regeneration” - almost completely survives some disturbances, like windthrows or tree die-backs (e.g. chapter III C). In contrast, tree seedlings and saplings are often destroyed during normal tree harvest and salvage logging or during a ground fire. Disturbances can also cause favourable and unfavourable microsites for tree regeneration. For example, mounds and pits are created during windthrows and this new microsites exhibit different conditions for the tree regeneration. In snag stands, however, no perturbation of the soil surface is normally caused.

Although many studies have been done about tree regeneration in clear cut or windthrow areas, scant attention has been given to the natural tree regeneration process after disturbance agents that kill standing trees (i.e. beetles, fungi). In particular there is a lack of knowledge about tree regeneration in steep snag stands in the Swiss Alps.

I B Motivation and objectives of the study

Natural disturbances drive forest ecosystem dynamics over a wide range of spatial scales. For example, a remarkably large disturbance was the windstorm ‘Vivian’ on 26 – 28 February 1990, which struck large parts of Western Europe. In Switzerland, ‘Vivian’ was the heaviest storm in the last century that struck mountain forests. A total of $4.9 \cdot 10^6$ m³ timber was thrown in Switzerland, including 268'000 m³ timber in the canton of Glarus (BUWAL 1994). The abundance of breeding material in the windthrow areas and the dry weather conditions that followed led to one of the largest known outbreak of European spruce bark beetle (*Ips typographus* L.) in Switzerland (Wermelinger *et al.* 1999). Overall, until 1995 bark beetles killed *Picea abies* trees on an area which amounted to about 60% of the area on which trees had been thrown by the wind (BUWAL 2000).

Due to the high cost associated with tree harvesting in the steep mountains of the Swiss Alps, harvesting all windthrow areas and snag stands was not attractive. Therefore the question arose, whether some of the snag stands could be left unharvested, or if this constitutes a risk with respect to the protection provided by some of these stands against natural hazards. The decision to leave snag stands unharvested in formerly managed forests was not without risks, because little was known about the decay process, the ground-vegetation succession and the tree regeneration development in steep, large snag stands compared with salvage logging. Above all, there was a lack of scientific understanding regarding natural succession processes in these areas and their relationship to various forest ‘services’ such as the protection of people and infrastructure from natural hazards. It is clear that snag stands that are to provide effective protection need a rapid restoration of the tree cover to maintain their protective effect (Chauvin *et al.* 1994, Mössmer 1998, Schönenberger 2000), i.e. before the snags, stumps and logs become ineffective. The main questions were therefore:

- **How long do snags, stumps and logs provide effective protection against natural hazards such as rock fall and snow avalanches?**
- **How fast will *Picea abies* and other tree regeneration grow in a snag stand and build a new protection forest?**

These questions cannot be answered generally for all snag stands in Switzerland. Therefore, a case study site was chosen. The Gandberg forest in the canton of Glarus, northern Swiss Prealps, was selected for this purpose because:

- 90% of the *Picea abies* trees had been killed by bark beetles within a few years
- the forest was dominated by *Picea abies*
- the snag stands cover a large continuous area (about 30 ha)
- the slope is an area of rockfall source and also a transit area of rockfall

- as long as it is non-forested or has large treeless gaps, the Gandberg forest is a potential area of downslope mass transfer, above all snow avalanches
- the forests had been managed formerly, but further harvesting will not occur since the forest became a nature reserve after tree die-back, so that observations of the succession will be possible over time.

However, the Gandberg forest is not classified as a protection forest with a ‘particular protection function’ because there are no people or assets downslope that may be damaged. Thus, the Gandberg forest provides a unique setting to study natural succession of a potential protection forest after *Picea abies* die-back.

Based on field observations, the short-term succession in the Gandberg snag stands will be described and analysed. In particular, the following more detailed questions will be addressed in this thesis:

Decay process:

- Is stem breakage or uprooting the more important process in *Picea abies* decay, especially as a result of storms?
- When do the snags break, and at what height?
- In which direction do the logs fall (parallel or diagonal to the slope)?
- What is the vertical height of the piled up logs and the remaining stumps?

Ground-vegetation succession:

- How does the ground-vegetation develop in the first years after *Picea abies* die-back?
- Which species benefits from the *Picea* die-back?
- Does the large amount of bark pieces accumulated on the ground after *Picea* die-back influence plant succession?

Tree regeneration development:

- Which tree species were present on the Gandberg in the first years after *Picea abies* die-back? How abundant are they, and what height and age (i.e. advance tree regeneration, tree seedlings or saplings) do they have?
- Does the large amount of bark pieces accumulated on the ground after *Picea* die-back influence the establishment of tree regeneration?
- Has browsing by ungulates caused a measurable loss of tree growth in the last 2-3 years?
- Is tree regeneration on logs already present in the Gandberg forest?

Long-term succession in the snag stands on the Gandberg cannot be described yet with field observations because decay and in particular the development of natural tree regeneration are quite slow processes in mountain regions (see 2.2 of chapter IA). Obviously, it would be risky to adopt the strategy ‘wait and see’ to determine what happens in an unharvested protection forest after *Picea abies* die-back. Instead,

mathematical modelling of snag stands can be used to study the future tree regeneration processes under these novel conditions. Therefore, the development and application of a tree regeneration model for the snag stands on the Gandberg was at the core of this PhD thesis.

Although such a model can only be based on field data from the first few years after the *Picea* die-back as well as data from studies in other sites, it is possible to perform simulations of the tree regeneration for several decades. Such long-term projections of the future development of the snag stands on the Gandberg serve to answer the following questions:

- Which tree species will be present on the Gandberg in the coming years?
- What tree densities and tree heights can be expected to occur within the coming years?
- When will the first trees enter the early pole stage (i.e. height > 5 m)?

It is clear that the uncertainty associated with the simulation results increases with time, but such a modelling approach has the potential to help us understand the basic processes of tree regeneration in snag stands. Assuming that the amount and height of tree regeneration which is required to provide effective protection in a stand is known or can be estimated (chapter IA), the main question about how fast *Picea abies* will form a new protection forest can be answered. Based on that, it is possible to evaluate at an early stage whether there are problems with respect to the amount and size of tree regeneration in a snag stand that should provide effective protection.

I C Study overview

In chapter II, the study site Gandberg forest is presented (II A) and the methods used for the various field observations are introduced (II B). Note that only an overview is given, no details about the methods are described because they are presented in detail in chapters III and IV.

Chapter III describes and discusses succession in the Gandberg forest during the first few years after the *Picea abies* die-back. Firstly, field methods to quantify stem volume and the decay process are presented, and the results are discussed (chapter III A). Secondly, ground-vegetation succession is described based on a study carried out in permanent plots (chapter III B). In chapter III C, the development of tree regeneration in the same permanent plots is studied.

Chapter IV describes the future succession of this Gandberg forest based on a model approach. To do so, first a suitable modelling approach had to be chosen. The chapter starts with a review of existing forest succession models, with special regard to the use of such a model to simulate tree regeneration in the snag stands of the Gandberg forest (IV A). In chapter IV B, the tree decay process and the ground-vegetation succession are projected into the future with a model that I have developed and applied to the snag stands on the Gandberg. In chapter IV C, the tree regeneration development of the Gandberg forest is predicted with a model called 'RegSnag' (Regeneration in a Snag stand), which was also constructed by myself.

In chapter V, these short- and long-term successional processes in the snag stands are discussed with respect to the protective effect of forests.

This PhD thesis ends with references of chapter I, II, IV A and V. The references of the articles published or submitted are listed in the individual chapters where the articles are reprinted, i.e. chapter III A-C and IV B and C.

The appendix contains the definition of the used microsite types (chapter VII A) and a detailed description of the model 'RegSnag' (chapter VII B-C), including a CD with the model implemented in the software STELLA®.

II MATERIAL AND METHODS

II A Study site Gandberg

1. Location, topography, geology and climate

The study site Gandberg is situated on the north face of the Gandstock, south of Schwanden (canton of Glarus, Switzerland), between the valleys Sernftal and Linthal (Fig. 1). The Gandberg forest is at an elevation of 1100-1600 m a.s.l. It inclines towards the North at an angle of about 14-36° (30-80%), except for a part that faces North-Northeast. The Gandberg forest is owned by three different municipalities (Schwanden, Schwändi and Ennenda).

Geologically, the Gandberg is composed of red conglomeratic Verrucano (Oberholzer and Heim 1910). The soil is an acid brown soil with a tendency to podsol (Roth 1996). Its depth varies greatly due to the presence of boulders deposited by rockfall. The Gandberg is a zone of rockfall origin, but also a transition zone for rockfall.

The Gandberg forest can be divided into two major elevational levels, i.e. a montane (1100-1450 m.a.s.l.) and a subalpine level (1450-1600 m.a.s.l.). These zones can then be further split into upper and lower parts (see chapter III A).

Orographic shading is the cause of no direct sunshine between October and April on the steeper parts of the montane elevational level; and on the subalpine level, potential direct sunshine in winter (October to February) is restricted to ca. 9-11 a.m.

Precipitation and temperature were not recorded directly in the Gandberg forest, but nearby at the bottom of the surrounding valleys (Tables 1 and 2). Annual air temperature decreases by about 0.6-0.7 °C every 100 m (Table 1) and is assumed to be slightly lower on a north facing slope than on south facing slopes or flat terrain. Hence, the mean annual temperature on the Gandberg site is estimated to be about 2-3 °C (Table 1), which is well within the atlas data from the Landestopographie (1997). This relatively mild climate is due to the influence of the frequent föhn, a strong, very warm wind from the Southern Alps. However, it is particularly the heavy west winds that represent a hazard for this forest (danger of windthrow, see chapter III A).

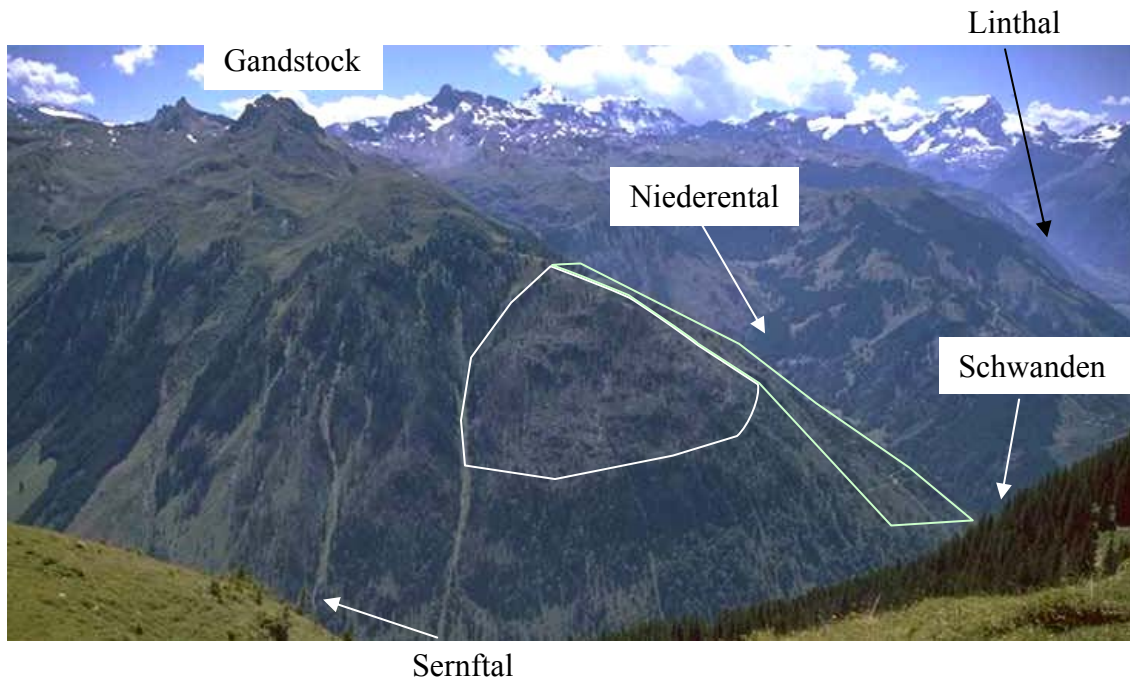

Fig.1: Snag stands along the north facing slopes of the valley Sernftal (around 100 ha), including the snags stands of the Gandberg forest (white perimeter, around 30 ha). The green perimeter shows the adjacent windthrow area above Schwanden. The photograph was taken in August 2000.

Table 1: Average annual temperature in Glarus, Tierfehd and Elm (MeteoSchweiz), atlas data of the Gandberg region (Landestopographie 1997) and based on these data an estimation for the Gandberg forest. Temperature was measured in Glarus since 1939, in Tierfehd (Linthal) since 1971 and in Elm (Sernftal) since 1964.

	Glarus (470 m)	Tierfehd (812 m)	Elm (962 m)	Atlas data for the Gandberg	Gandberg (1100-1600 m)
Temperature [° C]	7.5	6.0	5.4	0-5	ca. 2-3

Generally, the amount of precipitation increases with height above sea level (see e.g. Landestopographie 2001). The estimated mean annual precipitation for the Gandberg forest is 1600-2000 mm (Table 2).

Table 2: Average precipitation between 1901-1960 in Glarus, Tierfehd and Elm (MeteoSchweiz), atlas data of the Gandberg region (Landestopographie 1997, 2001) and based on these data an estimation for the Gandberg forest.

	Glarus (470 m)	Tierfehd (812 m)	Elm (962 m)	Atlas data for the Gandberg	Gandberg (1100-1600 m)
average precipitation [mm/year]	1447	1686	1540	1600-2400	ca. 1600-2000
average rainy days [days/year]	146	154	152	150-160	ca. 150

On the Gandberg, precipitation falls mainly in the form of snow between about October and May; and the Gandberg forest is normally covered by snow from about November to April (e.g. Landestopographie 2001). On the subalpine level, the average maximum snow height is estimated to about 1.6 m (Table 3). This estimation is mostly based on the measured snow depth in the nearby windthrow area (Table 3), but it was corrected for the higher altitude and the north-facing instead of west-facing aspect. On the montane level, snow depth is on average smaller (Table 3). The 100-year snow depth (HS_{100}) recurrence can be calculated in this region according to Landestopographie (2001) by:

$$HS_{100} = 2 * (0.15 * \text{elevation} - 20),$$

where elevation is the elevation above sea level (e.g. 1100-1600 m a.s.l.). With this equation, I calculated a HS_{100} of about 3-4.5 m for the Gandberg forest (Table 3). These data clearly show that in the absence of tree cover, the Gandberg would be an area of snow avalanching.

Table 3: Snow depth in Braunwald, Elm (both SLF-Vergleichstationen, data from W. Frey and SLF 2000), above Schwanden in the nearby windthrow area (Frey and Thee 2002), atlas data of the Gandberg region (Landestopographie 1997, 2001) and based on these data an estimation for the Gandberg forest.

location snow depth [cm]	Braunwald (1340 m)	Schwanden windthrow area (900- 1000 m)	Elm (962 m)	Atlas data for the Gandberg	Gandberg montane (1100- 1450 m)	Gandberg subalpine (1450- 1600 m)
average	120	ca. 50				
average max	260	84	250	230	ca. 100	ca. 160
measured max (1998/99)	320	168	>300	330	-	-
calculated max every 10 years	275				ca. 200	ca. 260
every 30 years	335	200			ca. 250	ca. 320
every 100 years	400				ca. 290-395	ca. 395-440

2. The wildlife reserve ‘Freiberg Kärpf’

Since 1548, the Gandberg has been a part of the wildlife sanctuary ‘Freiberg Kärpf’, which covers an area of 102 km² between the valleys Linthal and Sernftal. At least until 1865, the ungulates were fed with hay in the Gandberg forest (Forstverwaltung Kt. Glarus 1949). Nowadays, the entire Gandberg forest is an important habitat for chamois in summer (Schmidt 1983). 680 chamois (*Rupicapra rupicapra*), 173 red deer (*Cervus elaphus*) and 143 roe deer (*Capreolus capreolus*) were counted in the wildlife reserve in 1997 (Müller and Zopfi 1999). During my field work, I observed in average three chamois every day (Fig. 2), but no red deer and roe deer in the Gandberg forest.



Fig.2: Chamois (*Rupicapra rupicapra*) in the Gandberg forest, March 2003.

Besides ungulates, many other animals are present in the Gandberg forest, including mice, snakes (common viper), woodpeckers (e.g. *Picoides tridactylus*) and wren (*Troglodytes troglodytes*) to name just a few (e.g. Schmidt 1983, Kupferschmid 2001).

3. Forest structure

The entire Gandberg forest has been dominated by Norway spruce (*Picea abies* (L.) Karst.) at least since the clear-cut in the 19th century. Only a few silver fir (*Abies alba*, 1%) and sycamore maple (*Acer pseudoplatanus*, 3%) trees were present. The forest belongs to the *Galio-Abieti-Piceetum* association (Ott *et al.* 1997) at the montane level and to the *Homogyno-Piceetum vaccinietosum myrtilli* (Ott *et al.* 1997) at the subalpine level (Kägi 1992).

The stands at the montane level originate from natural tree regeneration after a clear-cut in 1842-1846 (Forstverwaltung Kt. Glarus 1949). On both elevational levels, the stands have undergone some high thinning. In 1949, the montane forest had a growing stock of about 640 m³ ha⁻¹ and was dominated by trees with a diameter at breast height of 35-50 cm (Forstverwaltung Kt. Glarus 1949). Growing stock of the forest in 1990 and 2000 is calculated in chapter III A.

The latest large mast years of *Picea abies* occurred in 1992 (Lässig *et al.* 1995) and 1995 (Burkart 2001).

4. Storms and bark beetles

In the Niederental south of Schwanden (canton of Glarus), the storm event 'Vivian' from 26 to 28 February 1990 destroyed about 154 ha of forest (Fig. 1, Marti 1995). Triggered by this event, *Picea abies* trees were killed by a large-scale bark beetle outbreak on an area of about 100 ha around the windthrow area and along the north facing slopes of the Sernftal (including the Gandberg forest, cf. Fig. 1 and 3). Especially in summer 1993, *Picea* trees in stands of totally ca. 20 ha were killed in the Gandberg forest alone (Fig. 4). High precipitation in the following years probably minimised further propagation of the bark beetles. In contrast, the wet weather conditions permitted antagonists of the bark beetles, such as parasitoids, predators and fungi, to control the bark beetles more effectively (Wermelinger *et al.* 1995, Forster 1998, Wermelinger 2000). Consequently, *Picea* trees of stands covering only about 6.6 ha were killed in 1994, and only a few islands of *Picea* trees and some scattered individual trees died between 1995 and 2000 (Fig. 4).

A more detailed review of the development of the bark beetle infestation on the Gandberg, including photo series of the die-back, can be found in Walcher and Kupferschmid (2001). The possible relationships between stand structure and the extensive bark beetle outbreak are discussed in chapter III A.

In 1994, the three municipalities that own these forests decided to leave the snags unharvested at elevations above 1100 m. However, below 1100 m, the forest will be converted actively into a deciduous forest which will be dominated by beech.



Fig. 3: Snag stands of the Gandberg forest and on the right side of the photograph parts of the adjacent windthrow area above Schwanden. The photograph was taken in August 2000.

In December 1999, another storm ‘Lothar’ caused again large windthrows in Switzerland (Eidg. Forschungsanstalt WSL and Bundesamt für Umwelt, Wald und Landschaft BUWAL 2001). However, on the Gandberg forest only some trees were broken, and almost no trees were uprooted (cf. chapter III A).

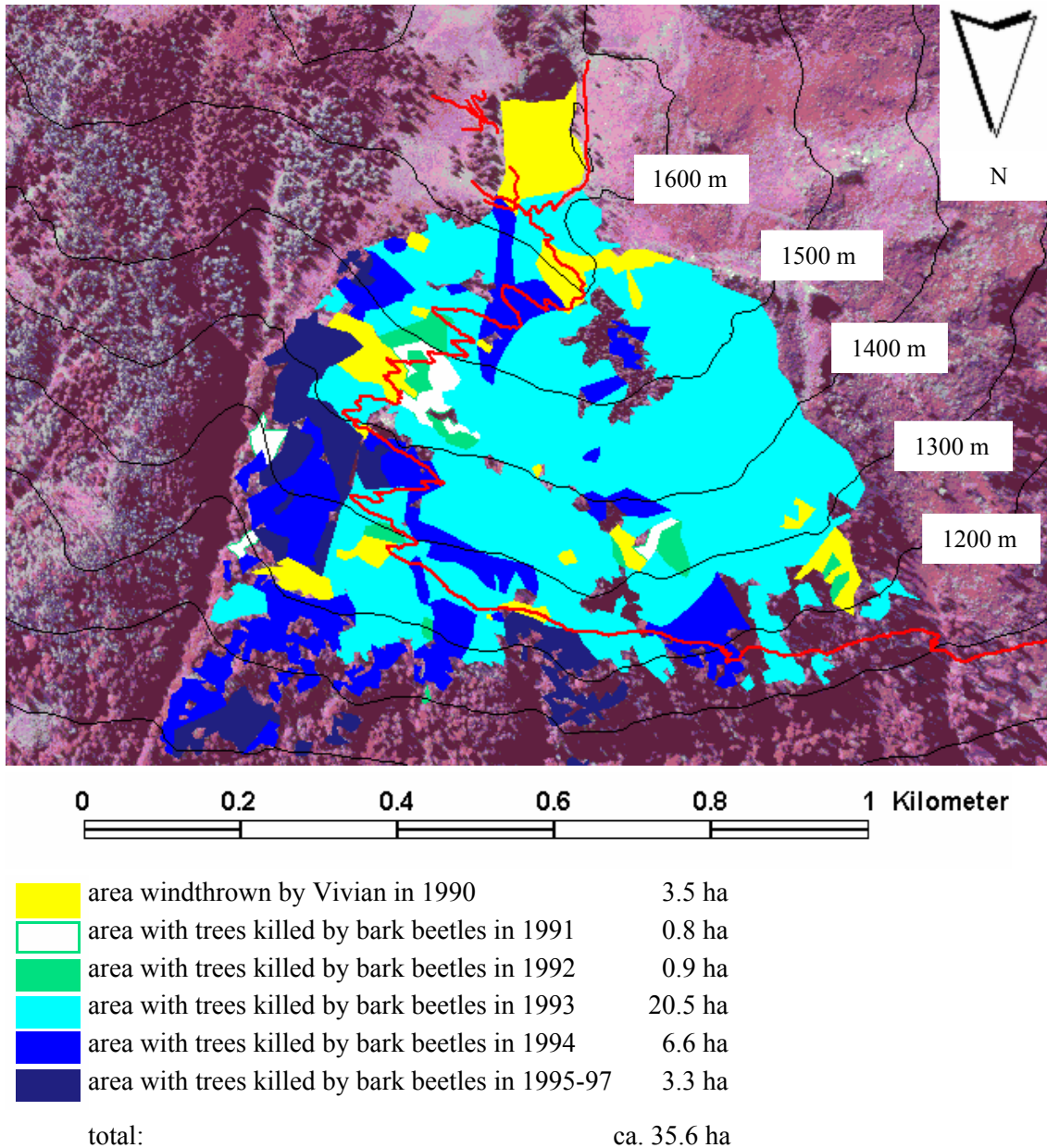

Fig. 4: Map of the time of tree death as I have reconstructed from terrestrial photographs of the Gandberg forest that were taken from the opposite mountain side in the years 1992 to 1999 (photographs courtesy of J. Walcher, Kt. Glarus). Black lines represent contour lines and red lines indicate the footpath through the snag stands. In the background a orthophotograph is shown (i.e. greyish blue trees are dead trees, red trees are alive).

II B Overview of the field surveys

In this chapter, an overview of all sample surveys is given. Firstly, the objectives underlying the various surveys are described. Secondly, the sampling methods are outlined and it is shown where the sampling units were located in the Gandberg forest. Details of the individual surveys are presented in the following chapters (III A-C and IV B-C).

1. Objectives of field surveys

All data that were collected on the Gandberg forest can be divided into 3 groups according to their purpose:

- **Data for describing short-term succession:** Some field surveys were carried out to describe wood-decay, ground-vegetation and tree-regeneration development during the first 8 years after *Picea abies* die-back. For this purpose, vegetation cover and tree regeneration have been observed annually in permanent plots since 1994. Along strip transects, a full callipering was carried out in which trees, snags, stumps and logs were measured in 2000. In addition, the height above the soil surface of the piled-up logs was measured along lines (line-intersect method). The sampling methods and results of these studies are described in chapters III A-C.
- **Data for model parameterisation:** Results from the above field surveys were also used to estimate the initial values of the models and to parameterise the model of wood-decay and ground-vegetation development (chapter IV B) and the model of tree-regeneration (chapter IV C). However, additional surveys were carried out only with the aim to better parameterise the models. They include a quantification of the frequencies of various microsite types in the permanent plots and in the strip transects, and measurements of the height increments of randomly sampled tree saplings. Sampling methods and results of these studies are described together with the models in chapters IV B-C.
- **Data for model validation:** Independent surveys on the Gandberg forest were carried out to test the accuracy of the simulation results of the models. Microsite type frequencies were quantified along lines (line-intercept method) and tree saplings were counted around these lines in strip transects in 2001. The sampling method and results of these surveys are described together with the models in chapters IV B-C.

2. Sampling methods

As is evident from the above description of the objectives of the field surveys, various sampling methods and units were used, including permanent plots, strip transects and lines. This was mostly due to the different spatial and temporal scales of the data required. The development of ground vegetation and early tree regeneration were observed on a scale of 1 m² (permanent plots), whereas stand structure, the decay processes of snags and the orientation of logs were investigated on a larger spatial scale of about 500 m² (long strip transects). The average height above the soil surface of the piled-up logs (i.e. lying dead trees) was most efficiently measured at the crossing points between lines and logs (line transects), and not on areas. Furthermore, ground vegetation and tree regeneration were observed in several time steps (i.e. annually) at the same locations to assess the succession (permanent plots), whereas the decay process of snags was reconstructed from different stands in which trees had died in 1992, 1993, 1994 or 1996 (long strip transects). Therefore, a space-for-time-replacement approach (i.e. zonation) was used to capture the snag-decay process and not a longitudinal study as for the ground vegetation and tree regeneration. The zonation approach could not be used for the reconstruction of the ground-vegetation succession because soil characteristics and slope exposition were slightly different in stands in which *Picea abies* had died in 1992, 1994 and 1996 as compared to stands in which *Picea* had died in 1993. For the decay of snags, this difference was assumed to be unimportant, and was neglected. In chapter III A, it is discussed whether this assumption was correct.

2.1 Long strip transects

In 2000, full callipering took place in 4 strip transects that were 5 m wide and 100-160 m long and were parallel to the contour lines (Fig. 1) at all four elevational levels (Fig. 5). The following measurements were carried out:

- number of living trees, snags and stumps in each snag stand crossed by the transects
- dbh, height, breakage height and breakage age of living trees, snags and stumps
- length, diameter and orientation of logs (= lying dead trees)
- frequency of microsite types within each 5 x 5 m grid of the strip transects (only in stands in which *Picea abies* survived or had died in 1993 or 1994)

The results of the tree measurements are described in chapter III A. Together with the frequencies of the microsite types, they were used to estimate the initial values and parameters of the decay and ground-vegetation model in chapter IV B.

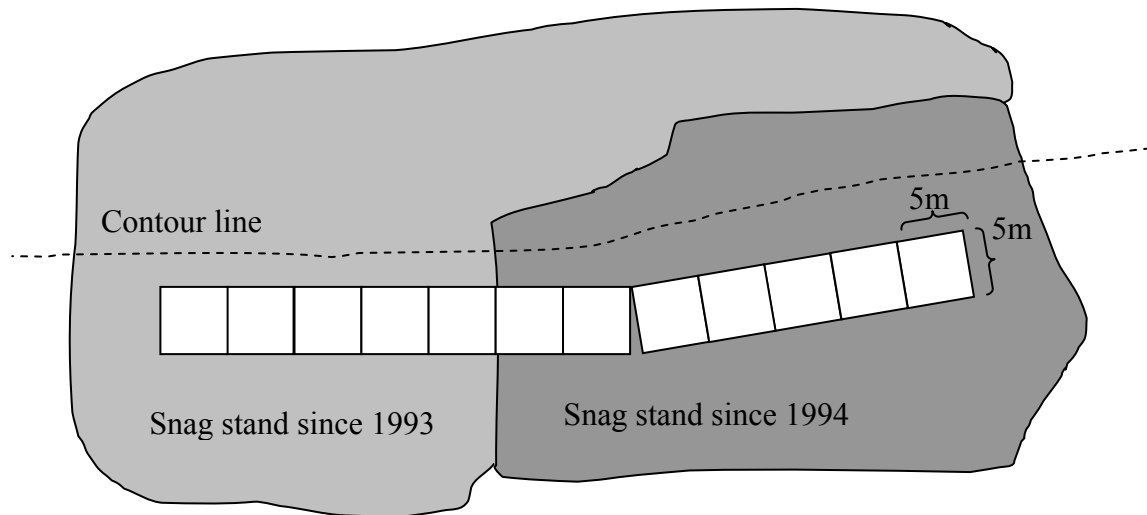

Fig. 1: Schematic sketch of a fictitious strip transect through the Gandberg forest (cf. Fig. 5).

2.2 Permanent plots

In 1994, the Swiss Federal Research Institute WSL (Birmensdorf) started a field experiment on the montane level of the Gandberg forest (cf. Fig. 5). The aims were (i) to observe the ground-vegetation development and natural tree regeneration, (ii) to assess the impacts of bark pieces on the ground-vegetation and the tree regeneration and (iii) to test the germination ability of *Picea abies* under these particular conditions. For these purposes, 24 permanent plots of 1 m x 1 m were arranged in a randomised block design with 4 treatments and 6 replicates (Fig. 2). From 12 of those plots, the bark litter was removed in 1994 and 1995. On 8 May 1995, 200 *Picea abies* seeds per plot were sown in one plot with and one without bark litter per block (total 12 plots).

The following measurements were carried out annually in the permanent plots:

- percent cover of each plant species, bark litter and branches
- number of newly established seedlings and number of dead saplings (the position of each tree was marked on a grid map)

The following measurements and observations were carried out additionally in 2001:

- height of *Rubus idaeus* plants
- height increment of trees in 1999 and 2000
- sapling damage caused by browsing, fungi or other impacts
- frequency of microsite types (definition of these types cf. Appendix chapter VII A)
- microsite types on which tree seedlings and saplings occurred (assignment method cf. Appendix chapter VII A).

The results of the ground-vegetation development are described in chapter III B, and the results of the natural tree regeneration surveys and the sowing experiment in chapter III C. The microsite type frequencies were used to parameterise the ground-vegetation model (chapter IV B).

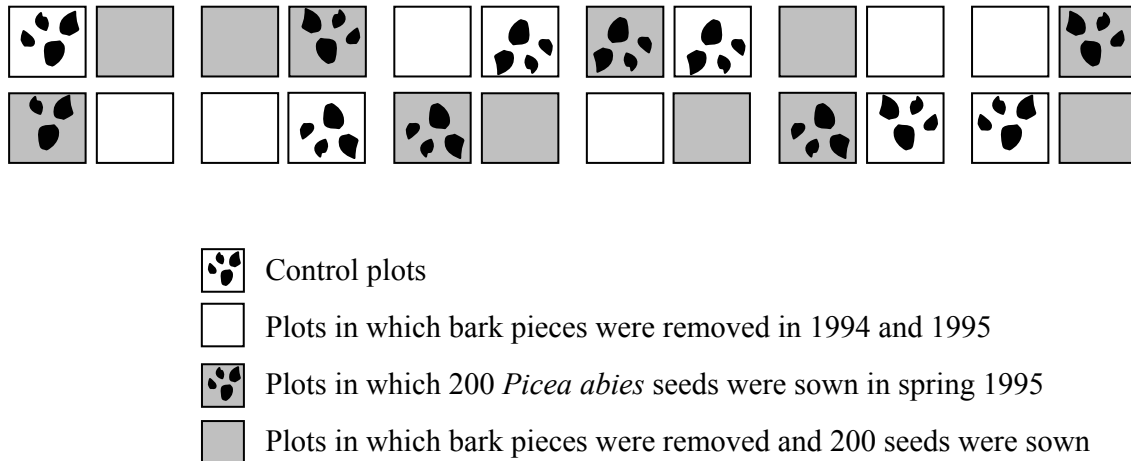

Fig. 2: Arrangement of the 24 permanent plots in 6 blocks in the Gandberg forest (cf. Fig. 5). Each block contained 4 plots, 1 control plot, 1 plot with bark pieces removed, 1 plot with bark pieces removed and 200 *Picea abies* seeds sown and 1 plot without bark removal but with 200 seeds sown in 1995.

2.3 Lines and surrounding strip transects

In June 2001, 128 lines of 10 m length were arranged in 8 blocks on each elevational level (Fig. 3 and 5). Along these lines, the height of the logs above the soil surface was measured at the crossing points with the lines (line-intersect method, Fig. 4A), and the lengths of 26 microsite types (defined in the Appendix chapter VII A) were measured (line-intercept method, Fig. 4B). From these intercepts, the frequencies of the microsite types were calculated (cf. chapter IV B). In 2 m wide strip transects around each of these lines (Fig. 4C), tree regeneration was assessed. For each tree seedling and sapling found, I noted (i) species, (ii) tree height, (iii) height increment in 1999 and 2000, (iv) browsing damage on terminal shoots, and (v) the microsite type it occupied (assignment cf. Appendix chapter VII A).

The results on the height of logs above the soil surface are described in chapter III A. The microsite type frequencies were used to test (i.e. validate) the accuracy of the simulation results obtained with the model of decay and ground-vegetation (chapter IV B), and the densities and heights of the seedlings and saplings were used to test the corresponding variables of the trees in the tree regeneration model (chapter IV C).

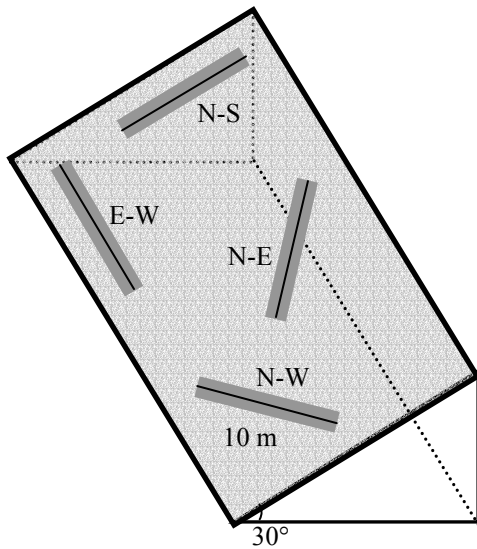

Fig. 3: Arrangement of the four 10 m long lines and surrounding 2 m wide strip transects in one block.

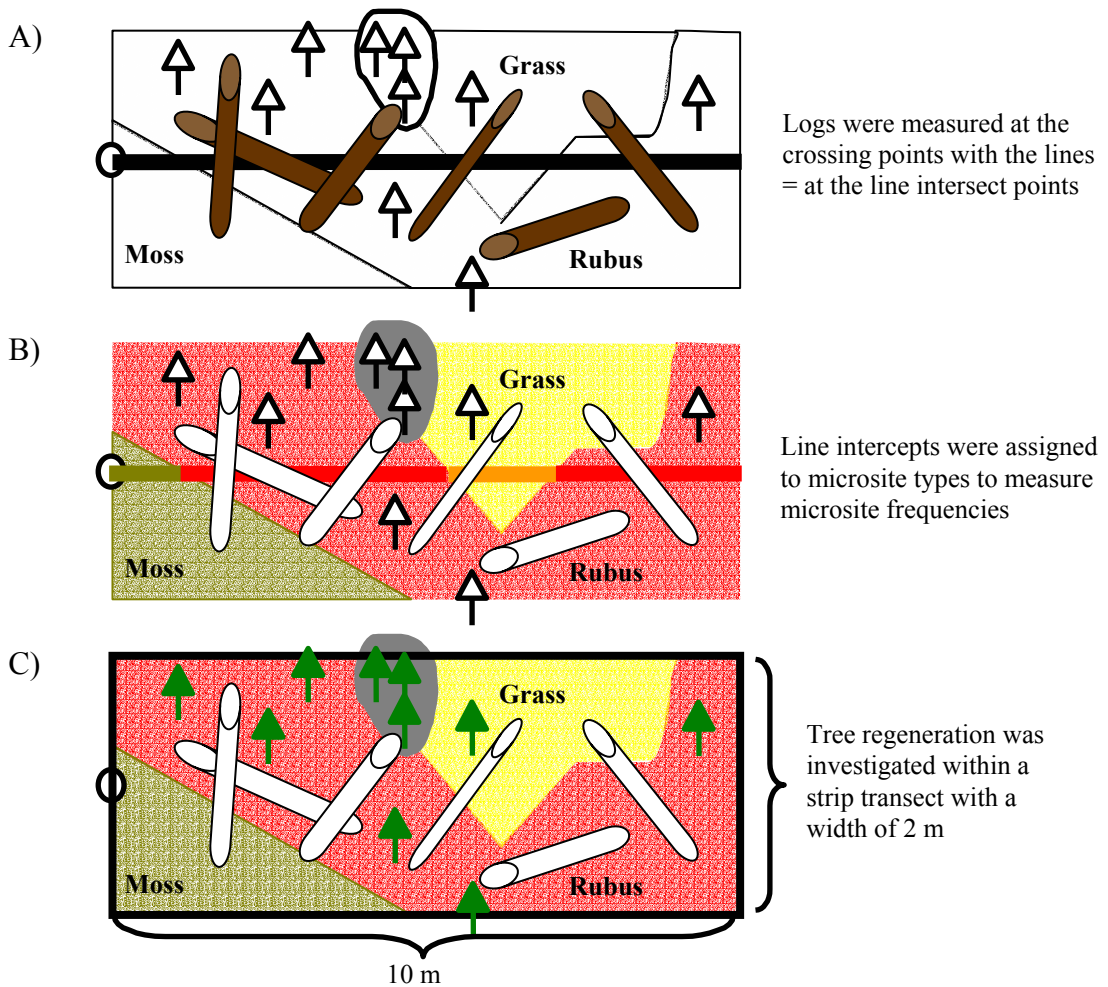

Fig. 4: Sampling methods which were used along all 10 m long lines and surrounding 2 m wide strip transects. A) line-intersect method, B) line-intercept method and C) strip transect method.

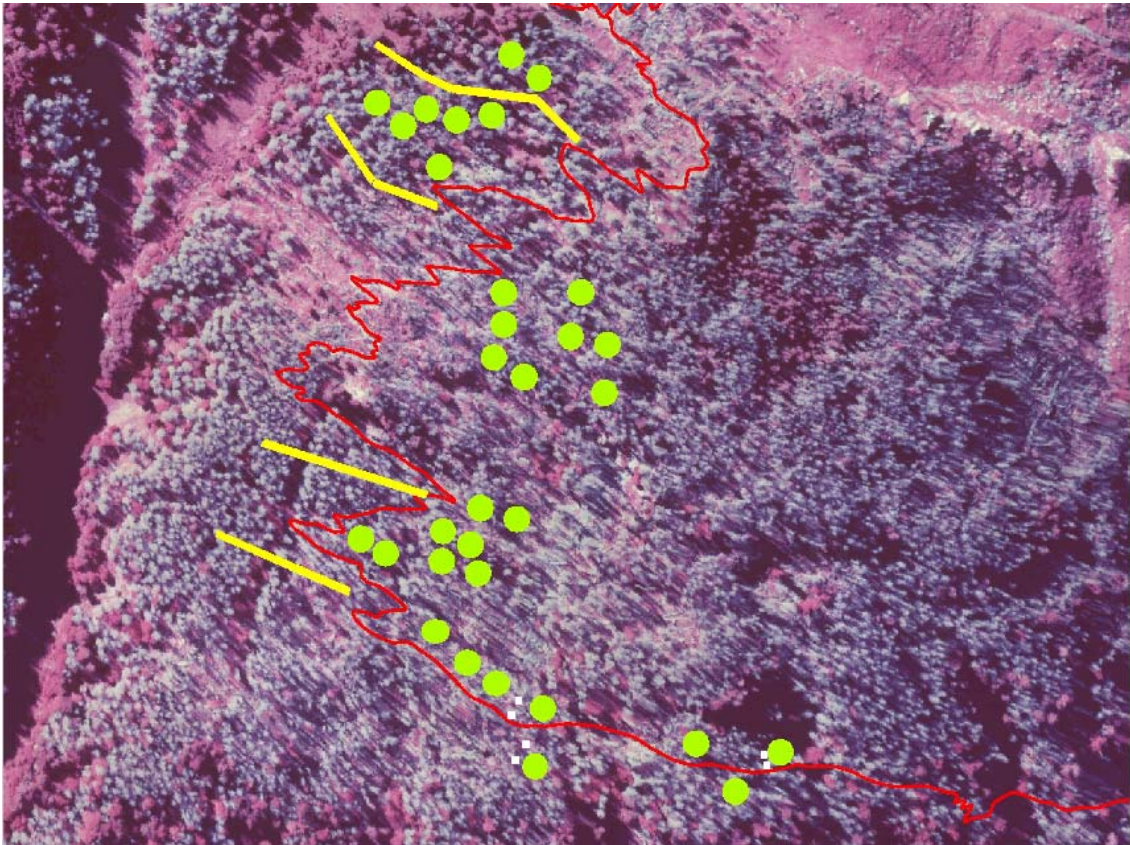

Fig. 5: Orthophoto of the Gandberg forest in 1998 with the location of the sampling units described in this section. White squares: location of a block of 4 permanent plots; yellow bars: long strip transects of 5 m x 100 – 160 m; green circles: block of 4 lines and surrounding strip transects.

2.4 Randomly sampled tree regeneration

Heights and height increment of unbrowsed *Picea abies* saplings were measured on the Gandberg forest (Fig. 6). A total of 113 saplings were randomly chosen in the snag stands at the subalpine level in the year 2001, and an additional 69 saplings in a *Picea* thicket on the lower montane level beneath the Gandberg snag stands in 2003.

The heights and shoot lengths of these saplings were used to estimate growth rates for the tree regeneration model (cf. chapter IV C).

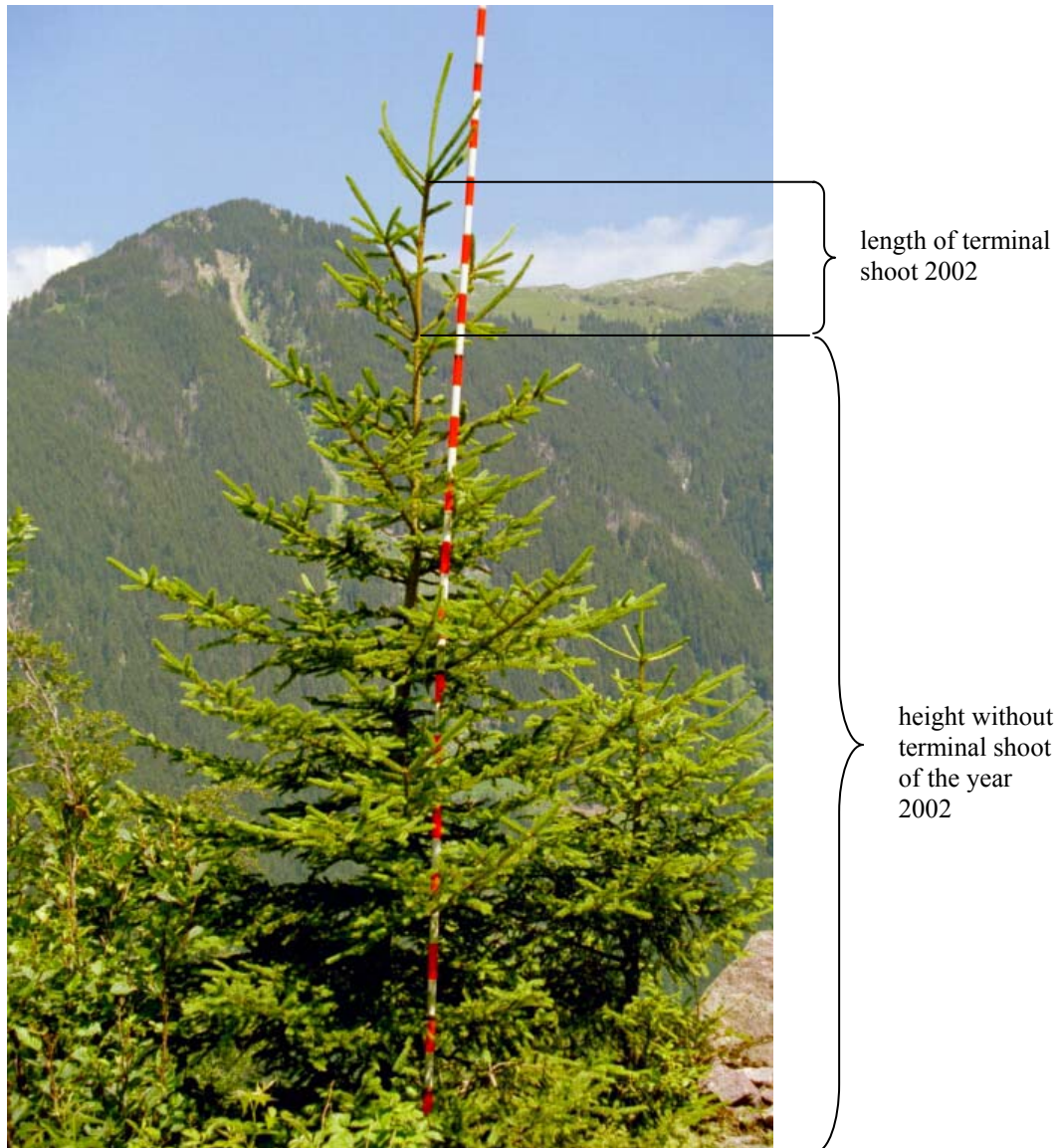

Fig. 6: Example of the measurement of absolute height and shoot length of an unbrowsed *Picea abies* sapling (< 5 m). Photograph was taken in the windthrow area adjacent to the *Picea* thicket in the Gandberg forest in June 2003.

III SHORT-TERM SUCCESSION

III A Decay process

Reprint of the published article:

Kupferschmid Albisetti A.D., Brang P., Schönenberger W. and Bugmann H. (2003): Decay of *Picea abies* snag stands on steep mountain slopes. *For. Chron.* 79(2): 247-252.



Photograph of the Gandberg forest on the montane elevational level in spring 2000. Bright tree break points document mostly breakage due to the storm 'Lothar' in December 1999, but also breakage during the rest of the winter 1999/2000.

Decay of *Picea abies* snag stands on steep mountain slopes

Kupferschmid Albisetti A.D., Brang P., Schönenberger W. and Bugmann H.

Abstract:

In a 30 ha *Picea abies* mountain forest in the Swiss Alps, almost all trees were killed by bark beetles (*Ips typographus*) between 1992 and 1996. Snag decay was studied using full-callipering within transects, and the height of lying logs above ground level was studied using the line intersect method. None of the dead trees had been uprooted, but 75% were found broken in 2000. The probability of snag breakage was independent of both tree diameter and time since stand death, but 28% of the snags broke close to the ground during a storm in December 1999. The log sections that were not in direct contact with the ground (73% of the log length sampled) were on average 85 cm above the soil surface in 2001. The orientation of the logs could be explained with the prevailing wind direction even on this steep slope. Leaving snag stands unharvested in *P. abies* forests on such slopes is likely to result in effective protection against rockfall and avalanche release for about 30 years.

Keywords: Norway spruce, bark beetle, decay process, rockfall, avalanche, mountain forest, Switzerland, decomposition, coarse woody debris.

1. Introduction

Mountain regions make up one-fourth of the earth's surface (Kapos *et al.*, 2000). Most mountain forests prevent or mitigate damage that natural hazards (i.e. snow avalanches, rockfall, debris flow) or adverse climate would otherwise cause to people or assets (Brang *et al.* 2001). The protective ability of mountain forests is mainly provided by the presence of trees. Living trees can stop falling stones, or at least reduce their velocity of fall (Cattiau *et al.* 1995, Gsteiger 1993). Also, tree crowns intercept snow that may either sublimate or evaporate directly from the crown, or drop as snow clumps or melt-water to the ground. Redistributed snow and melt-water affect the snow structure and prevent the formation of mechanically weak layers, which are a prerequisite for avalanche formation (Bründl *et al.* 1999).

Stand destruction by storms or bark beetles does not imply an immediate loss of the protective effect. At least during the first 10-30 years after a storm, broken trees, logs (i.e. stems of lying or broken trees) and treefall mounds may act as barriers for avalanches (Frey and Thee 2002) and rockfall (Gerber 1998). The height structure of

'obstacles' (e.g. logs, stumps and treefall mounds) is considered the most important variable in preventing avalanche release and rockfall, because these obstacles enhance surface roughness (Frey and Thee 2002, Gerber 1998). Notably, the vertical height of the piled up logs is about 0.5 - 2.5 m immediately after a windthrow (Frey and Thee 2002), and this increases roughness considerably. The spatial distribution and orientation of the logs are also crucial if they are to be effective in preventing rockfall. When logs lie diagonally relative to the slope, they are likely to be efficient in slowing down rolling stones, but perhaps not in stopping them entirely. However, if the logs are arranged parallel to the contour lines, stones may accumulate behind them (Gerber 1998). When such a log breaks due to advanced wood decay, the rocks piled up behind it may be released, giving rise to new rockfall. Another risk in very steep windthrow areas is that the logs themselves may become a safety hazard by sliding or rolling down-slope (Frey and Thee 2002).

Salvage logging of trees damaged by windthrow, snow break, bark beetles and avalanches is currently the most common forest practice in the Swiss Alps (49.4% of logging in the period 1983/85-1993/95, Brassel and Brändli 1999). However, harvesting trees on steep slopes is dangerous and quite costly. In protection forests, expensive avalanche barriers or fences to protect against rockfall are often constructed after salvage logging to ensure protection. The severe storm 'Vivian' in February 1990 triggered large-scale die-back of Norway spruce (*Picea abies* (L.) Karst.) stands caused by European spruce bark beetles (*Ips typographus*) in the following years (Wermelinger *et al.* 1999). The question arose whether such snag stands could be left unharvested, or whether this would constitute a safety hazard. There have been several studies of the persistence of living Norway spruce stands (Brückert *et al.* 2000, Peltola *et al.* 2000, Peterson and Pickett 1991) and unharvested windthrow areas (Frey and Thee 2002), but little is known about the decay dynamics of snag stands and their effectiveness in protecting against natural hazards. Snags were found to remain standing for long periods in dry *Picea engelmannii* stands in Utah (Hinds *et al.* 1965, Mielke 1950) and in *Pinus mugo* stands in the central Alps (Brang 1988), but the time between death and the first tree decay was only 2-3 years for Norway spruce trees in Russia (Tarasov and Birdsey 2001). Therefore, decay of *Picea abies* snags probably proceeds much faster in the oceanic European Alps than in semi-arid climates.

As mentioned above, leaving trees in protection forests unharvested after windthrow is not without risk, and this may also be the case after mortality due to beetle infestations. A literature search provided no answers to the following key questions for the northern Alps: (i) Is stem break or uprooting the more important process in *P. abies* snag decay, especially as a result of storms? (ii) When do the snags break, and at what height? (iii) In which direction will the logs fall (parallel or diagonal to the slope)? (iv) What will be the vertical height of the piled up logs and the remaining stumps? To address these questions, we investigated the decay of snag stands in which trees had

died in 1992, 1993, 1994 or 1996. These stands are all on a steep slope in the northern Swiss Alps. As long as this slope is ‘unforested’, it is a zone of rockfall origin and also a transit area for rockfall as well as an area prone to snow avalanche release.

2. Materials and methods

2.1 Study site

The study site Gandberg (30 ha) is situated south of Schwanden (Canton Glarus, Switzerland) at 1200-1600 m a.s.l and has a northerly aspect with a slope angle of about 30-80%. The entire Gandberg forest was dominated by *Picea abies* and belongs to the *Galio-Abieti-Piceetum* association (Ott *et al.* 1997) on the montane level and to the *Homogyno-Piceetum vaccinietosum myrtilli* association (Ott *et al.* 1997) on the subalpine level. Only about 1% of the trees were silver fir (*Abies alba* Mill.) and 3% were sycamore maple (*Acer pseudoplatanus* L.). At the montane level, the stands originated from a clear-cut in 1842-1846. On both elevational levels, the stands have undergone some high thinning (Forstverwaltung Kt. Glarus 1949). In 1949, the montane forest had a growing stock of about 640 m³ ha⁻¹ (Forstverwaltung Kt. Glarus 1949) and was dominated by trees with a diameter at breast height (dbh) of 35-50 cm. In February 1990, the severe storm Vivian caused scattered windthrows on the Gandberg forest, on a total area of 3.4 ha. Between 1992 and 1997, an outbreak of the European spruce bark beetle (*Ips typographus*) caused the death of almost all *P. abies* trees over approximately 100 ha in the northerly part of the Sernftal valley. The outbreak peaked in 1993, when about 20 ha of *P. abies* trees died in the Gandberg forest alone (Walcher and Kupferschmid 2001). The snags were left unharvested.

2.2 Field sampling and analysis

2.2.1 Callipering in strip transects

In summer 2000, we established strip transects along the contour lines at the elevational levels lower montane (1220-1300 m a.s.l.), upper montane (1310-1440 m a.s.l.), lower subalpine (1450-1530 m a.s.l.) and higher subalpine (1540-1600 m a.s.l.). The 4 transects crossed stands which had been attacked by bark beetles in 1992, 1993, 1994, or 1996 (Table 1). In these transects, the diameter at breast height (dbh) was measured using a slide calliper and the height of all snags (h) using the altimeter Suunto (Pardé and Bouchon 1988). The lower callipering limit was set to 16 cm dbh. The approximate time of breakage was estimated as: (1) before the storm Vivian 1990 (resulting in coarse woody debris); (2) during the storm Vivian 1990 (uprooted trees); (3) between the storm Vivian 1990 and the storm Lothar 1999 (stumps with dark breakpoint surfaces); or (4) during the storm Lothar in December 1999 (stumps with

bright breakpoint surfaces, or freshly uprooted trees). The orientation of all logs (i.e. stems of lying dead trees) in the strip transects was also recorded to a precision of 5°.

Based on these measured dbh (excluding trees broken before the storm Vivian 1990), the living stand volumes before the beetle infestation (1990) were calculated for all stands using the local timber tariff table of Schwanden for site class 20. Standing dead-wood volume in 2000 was estimated with the formula for calculating the volume of a truncated cone; $V = V_{\text{below breast height}} + V_{\text{above breast height}} = ((\text{dbh} + d_o)/4)^2 * \pi * 1.3 + ((\text{dbh} + d_b)/4)^2 * \pi * (h_b - 1.3)$ [m³], where d_o = diameter at tree base = dbh + 0.02 [m], h_b = height of the breakpoint (h, [m]), d_b = diameter at height of the breakpoint = dbh - $(h_b - 1.3) * 0.01$ [m]. The factor 0.01 implies a 1 cm diameter loss per 1 m of height above breast height. This factor was obtained by measuring diameters of logs.

Linear regression analyses were performed to evaluate (1) the number of broken snags, (2) the height of breakage (after a square root transformation) and (3) the snag-volume fraction (i.e. the volume of snags in percent of total dead-wood volume, after an arcsine transformation) using elevation, death year, aspect, dbh class and time of breakage as independent variables. The function 'lm' of the base package of the program 'R', Version 1.3.0, 2000, was used to this end.

2.2.2 Line-intersect sampling

At each of the four elevational levels, eight groups of lines were randomly selected in stands in which *P. abies* had died in 1993. Each group of lines contained four lines 10 m long which were parallel ('E-W'), perpendicular ('N-S') and at an angle of 45° to the contour lines ('N-W', 'N-E'). Along these 128 lines (4 elevational levels x 8 groups x 4 lines per group), the diameters of all logs which crossed the lines were measured at the point of intersection with the line (line-intersect method, De Vries 1974). The distance between the lower end of the log and the ground surface was also measured at that point in 2001.

3. Results

3.1 Growing stock

The average living timber volume calculated for 1990 was 816 m³ ha⁻¹ on the montane level and 593 m³ ha⁻¹ on the subalpine level (Table 1). Almost no snags were present before the storm Vivian 1990 (11% and 2% of the trees (Table 1), resulting in a timber volume of 3.3 and 0.3 m³ ha⁻¹). Mean diameter at breast height (dbh) was 40.2 cm with a standard deviation of 11.5 cm on the montane level, and 37.2 ± 11.7 cm on the subalpine level. The basal area was 84 m² ha⁻¹ on the montane level and 66 m² ha⁻¹ on the subalpine level. In 2000, between 17% and 97% of the volume of dead *Picea*

abies trees was still standing. This percentage was lower in stands that had died in 1992 than in stands that had died later (Table 1).

Table 1. Location and surface of the four strip transects on the Gandberg. The area of windthrown tree groups and a strip of forest on the two montane levels that was logged many decades ago and has still not regenerated were excluded from the surface calculation of the death years. Suffix n stands for north-east-facing stands and the rest are north-facing stands. Volume 1990 = volume [$\text{m}^3 \text{ha}^{-1}$] and numbers of living trees per ha in 1990 (in brackets), snags 2000 = volume of dead standing trees [$\text{m}^3 \text{ha}^{-1}$] and snag-volume proportion [%] calculated as volume of snags in percent of dead-wood volume, time of breakage = percent of trees broken either before the storm Vivian 1990, between the storms Vivian and Lothar, during the storm Lothar in December 1999 or not broken in 2000 (or only in the tree-top).

Elevational level	Height <i>Length</i>	Death year	Area [m^2]	Volume 1990 [$\text{m}^3 \text{ha}^{-1}$]	Snags 2000 [$\text{m}^3 \text{ha}^{-1}$]	Snags 2000 [%]	Time of breakage			
							before Vivian 1990 [%]	between Vivian and Lothar [%]	during Lothar 1999 [%]	not broken [%]
lower montane	1280	1992	156	922	453	49	10	30	20	40
	<i>110</i>	1993	84	710	515	73	14	14	43	29
		1994	106 ⁿ	1081	1049	97	0	20	20	60
upper montane	1360	1994	245	680	347	54	10	30	50	10
	<i>110</i>	1996	143 ⁿ	797	626	79	15	46	16	23
montane	220	all	882	816	545	68	11	31	29	29
				(560)						
lower subalpine	1520	1992	40	116	20	17	50	50	0	0
	<i>100</i>	1993	89	607	402	66	0	38	44	19
		1994	207 ⁿ	757	498	66	0	31	31	38
upper subalpine	1570	1993	320	904	484	54	0	57	17	26
	<i>160</i>	1994	198	603	351	58	0	71	14	15
subalpine	260	all	1116	593	346	59	2	51	25	23
				(513)						

3.2 Number of broken snags

In the strip transects in 2000, 75% of the trees were found broken and 25% were either not broken, or were broken only in the tree-top (29% on the montane level and 23% on the subalpine level, Table 1). No snags had been uprooted, even during the severe storm Lothar, but in average 28% of all trees burst during this storm (29% on the montane level and 25% on the subalpine level, Table 1). In the regression analysis (including the factors elevation, death date, aspect, dbh class and time of breakage), only aspect had a significant effect on the number of broken snags. Snags in stands on north-facing slopes were broken more often than those in stands on north-east-facing slopes ($n = 94$, $p = 0.011$), which has to do with the first stands being more exposed to the westerly storms. However, the number of broken trees was not different in smaller vs. larger diameter classes ($p = 0.37$), or between the death ages ($p = 0.716$).

3.3 Height of broken snags

In the strip transects in 2000, 25% of the trees were broken at a stem height between 10 m and the tree-top, and 50% at a height below 10 m. Death age was not significantly correlated with the height at which trees were broken, neither for trees broken before ($n = 40$, $p = 0.582$) nor for those broken during the storm Lothar ($n = 26$, $p = 0.744$, Fig. 1). However, time of breakage was significantly negatively related to breakage height ($p < 0.01$). The severe storm Lothar in 1999 often broke the snags at about 2-10 m, while in earlier storms most snags had broken near the tree-top or near bole height, i.e. near the lower crown end (Fig. 1). Therefore, the snag-volume fraction was smallest for trees broken by the storm Lothar ($n = 94$, $p < 0.01$). Thicker snags broke at similar heights to those of thinner ones ($p = 0.38$, Fig. 2).

3.4 Orientation of logs

In the lower and upper montane zones, most logs faced east or south-east (Fig. 3). This corresponds to the most frequent wind direction, i.e. westerlies. In the subalpine zone, the logs were more randomly oriented, i.e. they most often faced north, east and south (Fig. 3), corresponding to the westerlies (which locally may turn into north-westerlies or even northerlies) and foehn (warm southerlies). Orientation of the logs was not significantly related to year of death, tree dbh, or the time of breakage. Many logs were found far away from their stumps. Logs were often clumped, probably due to nearby clusters of snags, or because they slid down-slope and were stopped by large boulders or other logs.

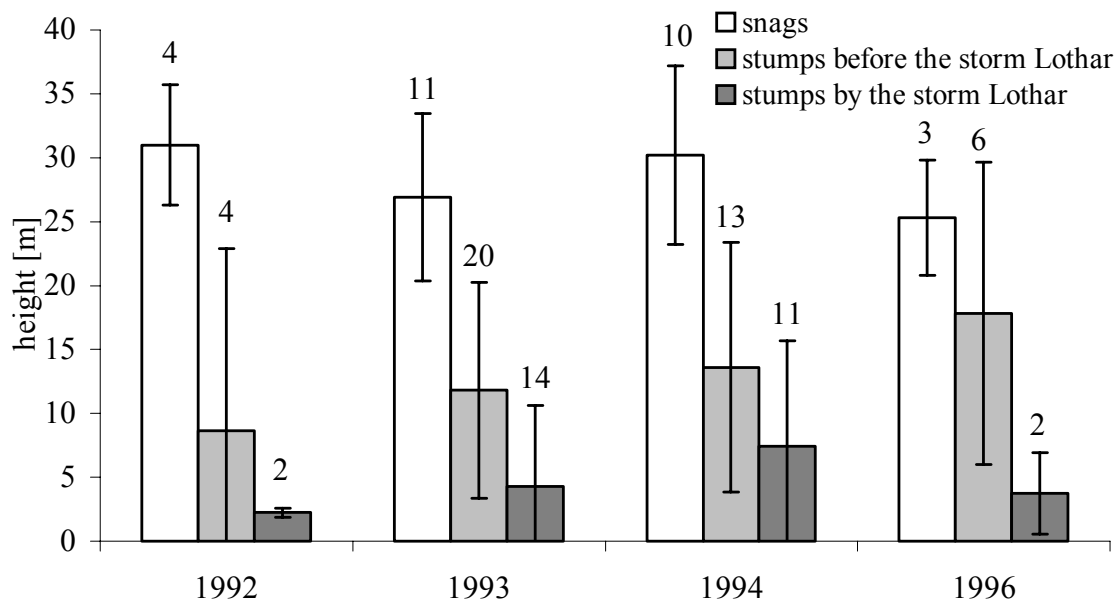

Fig. 1. Mean height \pm standard deviation of *Picea* snags and stumps in stands that had died 1992-1996 in the strip transects on the Gandberg. Figures represent numbers of measured trees.

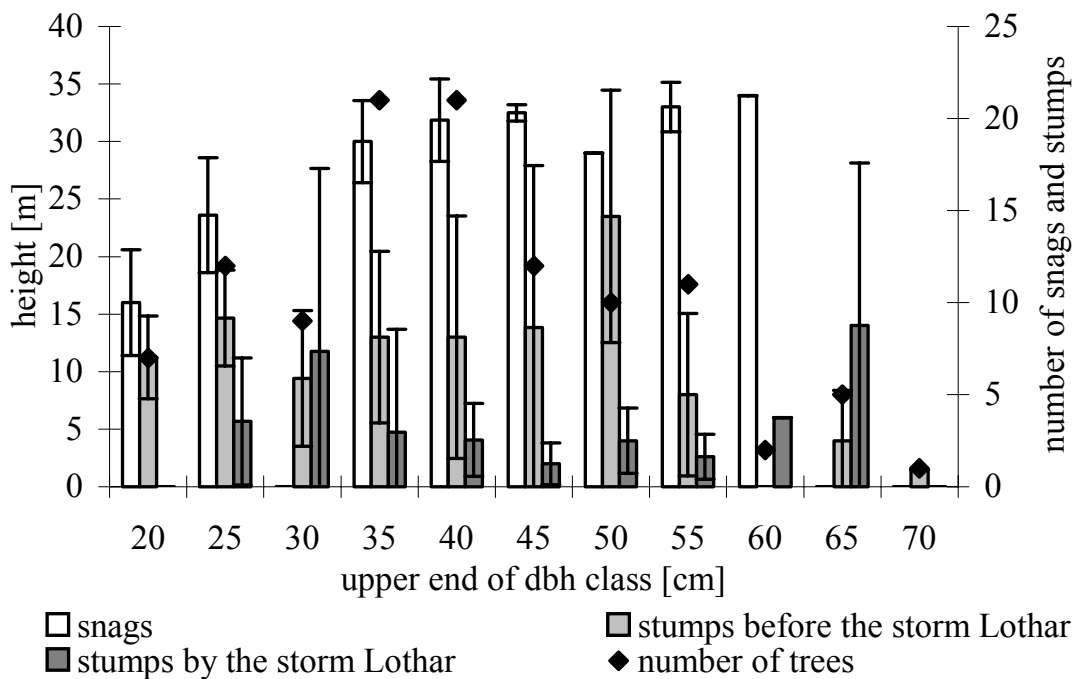

Fig. 2. Mean height \pm standard deviation and number of *Picea* snags and stumps in 5 cm diameter classes in the strip transects on the Gandberg.

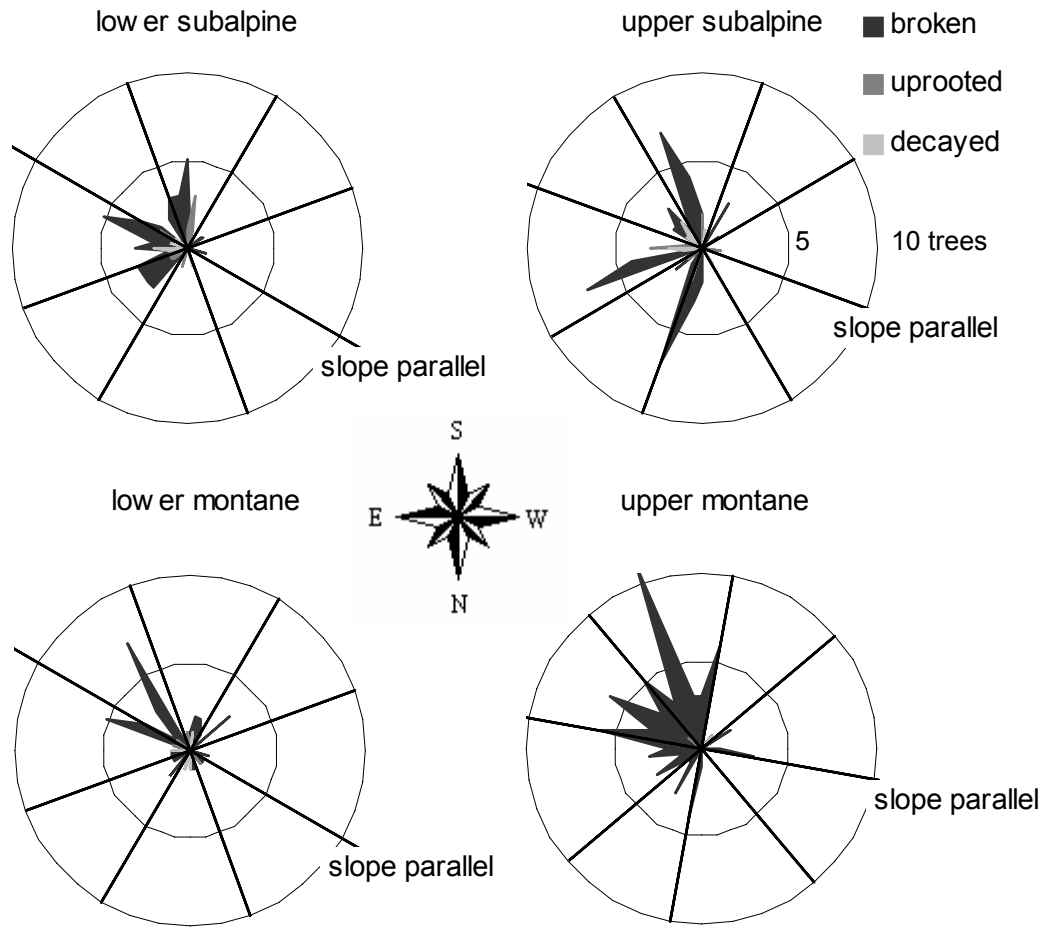

Fig. 3. Orientation of logs (i.e. stems of lying dead trees) in classes of 5° in the 4 strip transects of the north-facing Gandberg. Number of logs recorded were 63, 72, 51 and 77, on the lower subalpine, upper subalpine, lower montane, and upper montane level.

3.5 Ground contact of logs

The analysis of ground contacts of the logs at the intersection points revealed that the logs had direct ground contact on 27% of their total length, while 73% of their length was in the air, with an average distance to the forest floor of 85 cm (Table 2). At the upper subalpine level, logs had more ground contact (Table 2).

Table 2. Number of logs (N) crossing the 32 lines on each elevational level on the Gandberg, percent of logs lying with ground contact (lying) or without (hanging) and average height \pm standard deviation of logs without ground contact at the intersection point.

	elevation [m a.s.l.]	N	Logs		Height [cm]
			Lying [%]	Hanging [%]	
lower montane	1220-1300	195	26	74	97 \pm 60
upper montane	1310-1440	192	24	76	87 \pm 49
lower subalpine	1450-1530	191	24	76	72 \pm 42
upper subalpine	1540-1600	100	40	60	83 \pm 61
total		678	27	73	85 \pm 53

3.6 Nurse logs

Some tree seedlings and saplings were found on rotten pre-windthrow wood (logs and stumps) and on some uprooted trees (scattered windthrow 1990), but none on the logs that broke after 1990.

4. Discussion

4.1 Growing stock

The average living timber volume on the Gandberg in 1990 was higher than the average growing stock of mountain forest stands in the Swiss Alps, which amounts to about 320 m³ ha⁻¹ (Brassel and Brändli 1999). However, Bachofen and Zingg (2001) calculated 860 and 925 m³ ha⁻¹ for 73 years old *Picea abies* afforestations in Elm (Canton Glarus, 1410 m a.s.l.). The high values recorded in our study are due to the dense and rather uniform stands and the lack of thinning during the last decades. The high stand density may be one factor explaining the susceptibility of the stands on the Gandberg to bark beetles (cf. Christiansen and Bakke 1988, Becker and Schröter 2001).

4.2 Breakage of snags

Heavy storms are important factors in snag breakage. But why did the snags break at lower heights during the storm Lothar than before? Brown rot cuts cellulose microfibrils and can therefore cause dramatic losses in tensile strength of up to 70% after 6 weeks of incubation (Schwarze 1995). In Finland, *Fomitopsis* infections occurred mostly at the stem base and up to 1 m stem height (Norden 1997). In trees which had died in 1993 on the Gandberg, Hamdan (2002) found in 2001 *Fomitopsis pinicola* in 80% of the stumps that were shorter than 4 m, in 65% of the stumps that

were 4.1 to 20 m tall, but only in 37% of snags taller than 20 m. Consequently, we surmise that the increasing frequency of small stumps, i.e. lower breakages, is due to the advancing fungal decomposition in the lower parts of the snags. The high infection rate by *Fomitopsis* may also explain why the snags were broken, and not uprooted.

On the Gandberg, thicker snags did not stand unbroken for a longer time than thinner ones. This is inconsistent with findings for *Pinus* snags in Oregon (Bull 1983, Keen 1955) and with the positive correlation of the third power of dbh with the maximum resistive bending moment of Norway spruce (Peltola *et al.* 2000). However, Hamdan (2002) found *Fomitopsis* in all diameter classes on the Gandberg. This may have been the result of the spread of *Fomitopsis* by bark beetles (cf. Petty and Shaw 1986). It is well known that brown rots produce brittle wood in a short time (Schwarze *et al.* 1997, Wilcox 1978). Hence, 4 to 8 years after tree death, wood degradation was probably equally advanced in thicker and thinner snags, and their likelihood of breaking was therefore similar.

4.3 Orientation and height of logs

In the Gandberg forest, most logs were diagonally oriented (south-east or subalpine north-east), but some lay parallel to the contour lines which caused (and will lead to further) accumulation of other logs and some stones. However, these piles of more or less horizontally lying logs can provide effective protection against avalanche release (Frey and Thee 2002). Thus we conclude that at least at the moment, the risk of avalanches, erosion and rockfall would be higher if the snag stands of the Gandberg were logged.

The orientation of the logs corresponded with the main wind directions, enabling prediction of future tree-fall directions. We assume that trees will, in the future, continue to fall in directions similar to those of today in the Gandberg. If this happens, then logs will ensure efficient stone retention, but there will also be a risk of undesired accumulations of stones behind logs.

4.4 Protective effect of the stands

Logs decay faster near soil surface due to higher moisture content of logs on the ground and in the vegetation than above that. The stems of uprooted trees with ground contact are expected to withstand snow loads effectively for at least 10-20 years, and those without ground contact for about 30 years (Frey and Thee 2002). Logs originating from snags have hardly any branches at time of snag breakage and are thus wedged at lower distances from the ground surface than uprooted trees. Therefore, the logs in the Gandberg were already closer to the ground (average distance 85 cm) 8 years after tree death and were more exposed to humidity at the ground surface, than logs in an adjacent

uncleared windthrow site 10 years after the storm Vivian (average distance 110 cm, Frey and Thee 2002). However, the decay of snags proceeds slower than the decay of uprooted trees because the wood of snags is drier (Schwarze 1995). This retarded decay of snags may compensate for the quicker proximity to ground surface of logs originating from snags and, therefore, overall decay rate is probably similar in both the snag stand Gandberg and the adjacent windthrow area. We tend to conclude that the snags, stumps and logs of the Gandberg will provide effective protection against natural hazards for about 30 years. Afterwards, tree regeneration will have to provide protection. In 30 years, the logs will probably have become important as nurse logs for tree regeneration (cf. Ott *et al.* 1997), which is another reason in this case for leaving the snag stands uncleared.

Acknowledgement

We would like to thank Stefan Landolt, Ulrich Wasem and Marc Battaglia and the forest service of Schwanden for their help during fieldwork. This study was supported by the Foundation for the Advancement of Forest and Wood Research, by the government of Canton Glarus and by the Swiss Federal Research Institute for Forest, Snow and Landscape Research (WSL).

5. References

- Bachofen H. & Zingg A. (2001): Effectiveness of structure improvement thinning on stand structure in subalpine Norway spruce (*Picea abies* (L.) Karst.) stands. *For. Ecol. Manage.* **145**(1-2): 137-149.
- Becker T. & Schröter H. (2001): Die Ausbreitung des Borkenkäferbefalls im Bereich von Sturmwurf-Sukzessionsflächen. *Ber. Freibg. Forstl. Forsch.* Heft **26**: 1-79.
- Brang P. (1988): Decline of mountain pine (*Pinus mugo* ssp. *uncinata*) stands in the swiss national park - a dendrochronological approach. *Dendrochronologia* **6**: 151-162.
- Brang P., Schönenberger W., Ott E. & Gardner B. (2001): Forests as protection from natural hazards. In: Julian Evans (ed.) *The forest handbook*. Blackwell Science. 53-81.
- Brassel P. & Brändli U.-B. (1999): *Schweizerisches Landesforstinventar. Ergebnisse der Zweitaufnahme 1993-1995*. Verlag Paul Haupt, Bern. 442 p.
- Brückert F., Becker G. & Speck T. (2000): The mechanics of Norway spruce (*Picea abies* (L.) Karst): mechanical properties of standing trees from different thinning regimes. *For. Ecol. Manage.* **135**: 45-62.
- Bründl M., Schneebeli M. & Flüeler H. (1999): Routing of canopy drip in the snowpack below a spruce crown. *Hydrol. Process.* **13**(1): 49-58.
- Bull E.L. (1983): Longevity of snags and their use by woodpeckers. *USDA, For. Serv. Gen.Tech.Rep. RM* **99**: 64-67.

- Cattiau V., Mari E. & Renaud J.-P. (1995): Forêt et protection contre les chutes de rochers. *Ingénieries: EAT* **1**(3): 45-54.
- Christiansen E. & Bakke A. (1988): The spruce bark beetle of Eurasia. In: Alan Andrew Berryman (ed.) *Dynamics of forest insect populations*. Plenum, New York. 480-503.
- De Vries P.G. (1974): Multi-stage line intersect sampling. *Forest Sci.* **20**(2): 129-133.
- Forstverwaltung Kt. Glarus (1949): Wirtschaftsplan über die Gemeindewaldungen von Schwanden (1. Revision). *Unveröffentlicht*. Forstverwaltung Kt. Glarus, Glarus.
- Frey W. & Thee P. (2002): Avalanche protection of windthrow areas: A ten year comparison of cleared and uncleared starting zones. *For. Snow Landsc. Res.* **77**(1/2): 89-107.
- Gerber W. (1998): Grundlagen zur Beurteilung des Steinschlagprozesses. In: Schweizerische Gebirgswaldpflegegruppe (ed.) *Dokumentation der 14. Arbeitstagung der schweizerischen Gebirgswaldpflegegruppe (GWG) mit der FAN: Waldwirkungen und Steinschlag*. WSL, Grafenort / Engelberg OW.
- Gsteiger P. (1993): Steinschlagschutzwald: Ein Beitrag zur Abgrenzung, Beurteilung und Bewirtschaftung. *Schweiz. Z. Forstwes.* **144**(2): 115-132.
- Hamdan A. (2002): Dominante Fäuleerreger an der Stammbasis stehender toter Fichten am Gandberg, Kt. Glarus. *Diplomarbeit*. Professur für Forstschutz und Dendrologie, Departement Forstwissenschaften, ETH, Zürich. 51 p.
- Hinds T.E., Hawksworth F.G. & Davidson R.W. (1965): Beetle-killed Engelmann spruce. Its deterioration in Colorado. *J. For.* **63**(7): 536-542.
- Kapos V., Rhind J., Edwards M., Ravilious C. & Price M.F. (2000): Developing a map of the world's mountain forests. In: M.F. Price & N. Butt (eds.), *Forests in sustainable mountain development: A state-of-knowledge report for 2000*. CAB International, Wallingford, UK.
- Keen F.P. (1955): The rate of natural falling of beetle-killed ponderosa pine snags. *J. For.* **53**:720-732.
- Mielke J.L. (1950): Rate of deterioration of beetle-killed Engelmann spruce. *J. For.* **48**(12): 882-888.
- Norden B. (1997): Genetic variation within and among populations of *Fomitopsis pinicola* (Basidiomycetes). *Nord. J. Bot.* **17**(3): 319-329.
- Ott E., Frehner M., Frey H.-U. & Lüscher P. (1997): *Gebirgsnadelwälder: Ein praxisorientierter Leitfaden für eine standortgerechte Waldbehandlung*. Verlag Paul Haupt, Bern, Stuttgart, Wien. 287 p.
- Pardé J. & Bouchon J. (1988): *Dendrométrie*, 2 edition. Engref, Nancy. 328 p.
- Peltola H., Kellomäki S., Hassinen A. & Granander M. (2000): Mechanical stability of Scots pine, Norway spruce and birch: an analysis of tree-pulling experiments in Finland. *For. Ecol. Manage.* **135**: 143-153.
- Peterson C.J. & Pickett S.T.A. (1991): Treefall and resprouting following catastrophic windthrow in an old-growth hemlock-hardwoods forest. *For. Ecol. Manage.* **42**: 205-217.
- Petty T.M. & Shaw C.G. (1986): Isolation of *Fomitopsis pinicola* from in-flight bark beetles (Coleoptera: Scolytidae). *Can. J. Bot.* **64**(7): 1507-1509.
- Raphael M.G. & Morrison M.L. (1987): Decay and dynamics of snags in the Sierra Nevada, California (USA). *For. Sci.* **33**(3): 774-783.

- Schwarze F. (1995): *Entwicklung und biomechanische Auswirkungen von holzzersetzenden Pilzen in lebenden Bäumen und in vitro*. SVK-Verlag, Erndtebrück. 163 p.
- Schwarze F., Lonsdale D. & Fink S. (1997): An overview of wood degradation patterns and their implications for tree hazard assessment. *Arboricultural J.* **21**: 1-32.
- Tarasov M.E. & Birdsey R.A. (2001): Decay rate and potential storage of coarse woody debris in the Leningrad region. *Ecol. Bull.* **49**: 137-147.
- Walcher J. & Kupferschmid A.D. (2001): Borkenkäfer-Schadenflächen bei Schwanden. In: T. Rageth (ed.) *Binding Preis für vorbildliche Waldpflege 2001: Vivian als Chance. Gemeinde Schwanden GL*. Sophie und Karl Binding Stiftung, Basel. 43-45.
- Wermelinger B., Obrist M.K., Duelli P. & Forster B. (1999): Development of the bark beetle (Scolytidae) fauna in windthrow areas in Switzerland. *Mitt. Schweiz. Entomol. Ges.* **72**: 209-220.
- Wilcox W.W. (1978): Review of literature on the effects of early stages of decay on wood strength. *Wood and Fiber Science* **9**(4): 252-257.

III B Development of ground vegetation

Reprint of the published article:

Kupferschmid A.D. (2002): Bark influence on vegetation development in a dead *Picea abies* mountain forest. In: Bottarin R. & Tappeiner U. (eds.), *Interdisciplinary mountain research*. Blackwell Science, Berlin. 242-247.



Photographs of one of the permanent plots in the Gandberg forest (plot # 63); left: in summer 1994 (photograph courtesy of U. Wasem, WSL), right: 26 September 2000.

Bark influence on vegetation development in a dead *Picea abies* mountain forest

Andrea D. Kupferschmid

Swiss Federal Research Institute WSL, Zürcherstrasse 111, CH-8903 Birmensdorf, Switzerland.
andrea.kupferschmid@wsl.ch

Abstract:

In a steep *Picea abies* mountain forest in the alpine foothills of northern Switzerland, trees were killed by *Ips typographus* in 1993 and left unharvested. Since this death the ground-vegetation development has been studied on permanent plots. From 1993 till 2001 the ground-vegetation of the *Galio-Abieti-Piceetum* association changed into a *Rubus idaeus* brushwood. Even if 50% of the soil surface was covered with bark litter pieces in 1994, bark reduced the frequency of *Polytrichum formosum* only in the first years after the death of *Picea*.

Keywords:

Forest regeneration, snags, bark beetle, *Polytrichum formosum*, *Rubus idaeus*.

Nomenclature:

Lauber and Wagner (1996) for ground-vegetation and tree species; Jahns (1995) for mosses.

1. Introduction

Disturbances are important processes in forest dynamics. An example of a large disturbance was the windstorm event ‘Vivian’ in 1990, which struck large parts of Western Europe and triggered die-backs caused by *Ips typographus* (Wemelinger *et al.* 1999). Due to the high cost associated with tree harvesting in the steep mountains of the Swiss Alps, the question arose whether some of these steep formerly managed forests could be left unharvested. This decision, however, is not without risks; little is known about the succession of the ground vegetation and the tree regeneration in large snag stands (e.g. Reif and Przbylla 1995) as compared with windthrow areas and clear-cuts (e.g. Carlton and Bazzaz 1998, Fischer 1998, Peterson and Picket 1990).

In the highlands of the Bavarian National park in Germany, *Calamagrostis villosa* reached predominance after the death of the Norway spruce stands (Reif & Przbylla 1995). Sinner (1999) supposes that bark pieces and needles can prevent this grass invasion around dead trees. However, it is unknown how a dense cover of bark pieces influences the development of the ground vegetation in a steep mountain forest with few

grasses. The natural succession of the ground vegetation in a large dead forest was therefore investigated in 12 permanent plots with bark and 12 plots with bark removed.

2. Materials and Methods

2.1 Study site

The study site is situated on the north face of the Gandstock, south of Schwanden (canton of Glarus, Switzerland) at an elevation of 1220-1260 m a.m.s.l. The Gandberg inclines towards the North (30-80%). The soil is an acid brown soil with a tendency to podsol and its depth varies strongly due to the presence of Verrucano boulders. The estimated mean annual precipitation for the Gandberg forest is 1600-2000 mm and the estimated mean annual temperature is 2-3 °C.

The entire Gandberg forest was dominated by *Picea abies*. The site belongs to the *Galio-Abieti-Piceetum* association (Kaegi 1992). In 1992, the ground vegetation was dominated by the mosses *Dicranella heteromalla*, *Dicranum scoparium*, *Polytrichum formosum* and by *Oxalis acetosella* (Kaegi 1992). The stands grew up after a clear-cut in 1842-1846 (Forstverwaltung Kt. Glarus 1949).

In 1993, a bark beetle (*Ips typographus*) outbreak, triggered by the wind-throw event from Hurricane Vivian in 1990, caused the death of almost all *Picea abies* trees on the Gandberg (30 ha) and surrounding area (overall 100 ha).

2.2 Methods

In 1994, the Swiss Federal Research Institute WSL (Birmensdorf) started a pilot experiment with 24 permanent plots of 1 x 1 m² in the montane zone of the Gandberg (1220-1260 m a.m.s.l.). From 12 of those plots, bark litter was removed in 1994 and 1995. Since 1994, the ground-vegetation cover of plants and mosses with a frequency higher than 5% was estimated annually on all plots. A cover of more than 100% was possible. Bark influence on ground vegetation was tested with ANOVA, including the Repeated Measurement Analysis function of Systat 7.0.1.

3. Results

Vegetation development after the death of the stand

In 1994, the ground vegetation was dominated by *Oxalis acetosella* (Fig.1). Other species were not present, apart from some moss cushions of *Polytrichum formosum* and very little *Hylocomium splendens*, *Thuidium tamariscinum* and *Dicranum scoparium* (Fig. 1). These mosses increased their cover over the next few years and other mosses, such as *Plagiothecium undulatum*, *Plagiomnium sp.*, *Rhizomnium sp.* and *Pleurozium schreberi* reached a cover of more than 5% in at least one of the plots (not included in Fig. 1). *Rubus idaeus* started to invade the plots in 1995, together with *Dryopteris dilatata* and some *Dryopteris carthusiana*, *Athyrium filix-femina* and *Oreopteris limbosperma* (all ferns counted as *Dryopteris* in Fig. 1) and a few individuals of *Sambucus racemosa* and *Vaccinium myrtillus* (not included in Fig. 1). *Epilobium angustifolium* emerged in 1996 and *Rubus cf fruticosus* in 2000. Since then, *Rubus idaeus* has become the most frequent herb.

Although bark was removed from the plots only during 1994 and 1995, the amount of bark litter remained higher on the undisturbed plots until 1999 (Fig. 2, ANOVA, 1994-1999 each $p < 0.001$). *Polytrichum formosum* was the only species negatively affected by the presence of bark litter during this time (Fig. 1, ANOVA 1994-1999, $p = 0.04$). At first, *Oxalis acetosella* tended to be more frequent on the bark-free plots (Fig.1, ANOVA 1994-1995, $p = 0.06$), but from 1998 till 1999 it was more frequent on the undisturbed plots (ANOVA 1998-1999, $p = 0.04$). By then, bark had already become scarce.

In 2000 and 2001 there was no difference in bark litter cover between the treatments, due to few bark pieces which fell down from surrounding snags and logs (Fig. 2). Since then there was also no more any difference in the cover of *Polytrichum formosum* and *Oxalis acetosella* (ANOVA 2000-2001, $p > 0.84$, $p = 0.35$). The cover of all the other species was never affected by the presence of bark litter.

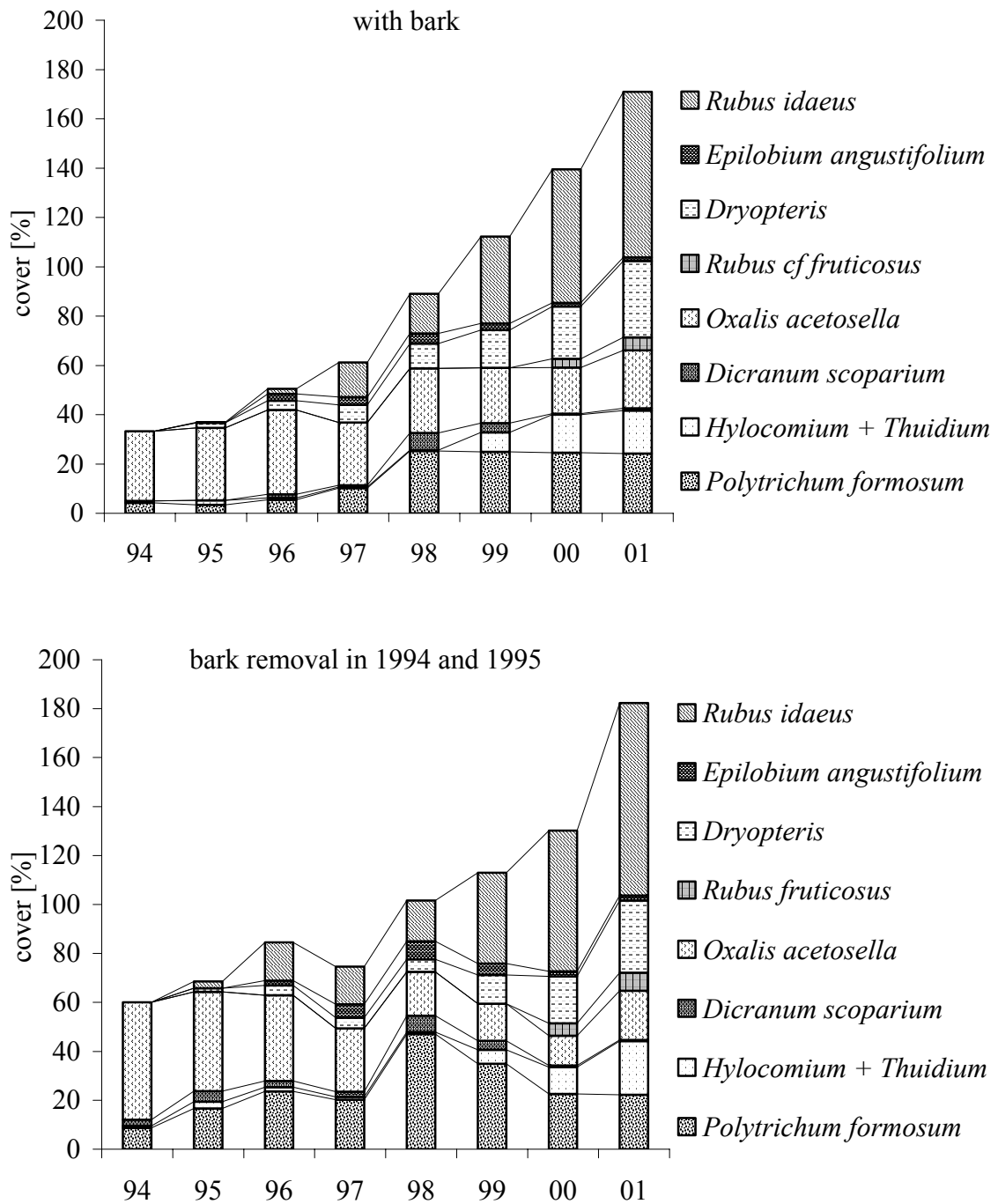

Fig. 1: Ground-vegetation development in the 24 permanent plots. The bark was removed in 1994 and 1995 from 12 of the plots. Only the most frequent herbs and mosses were included.

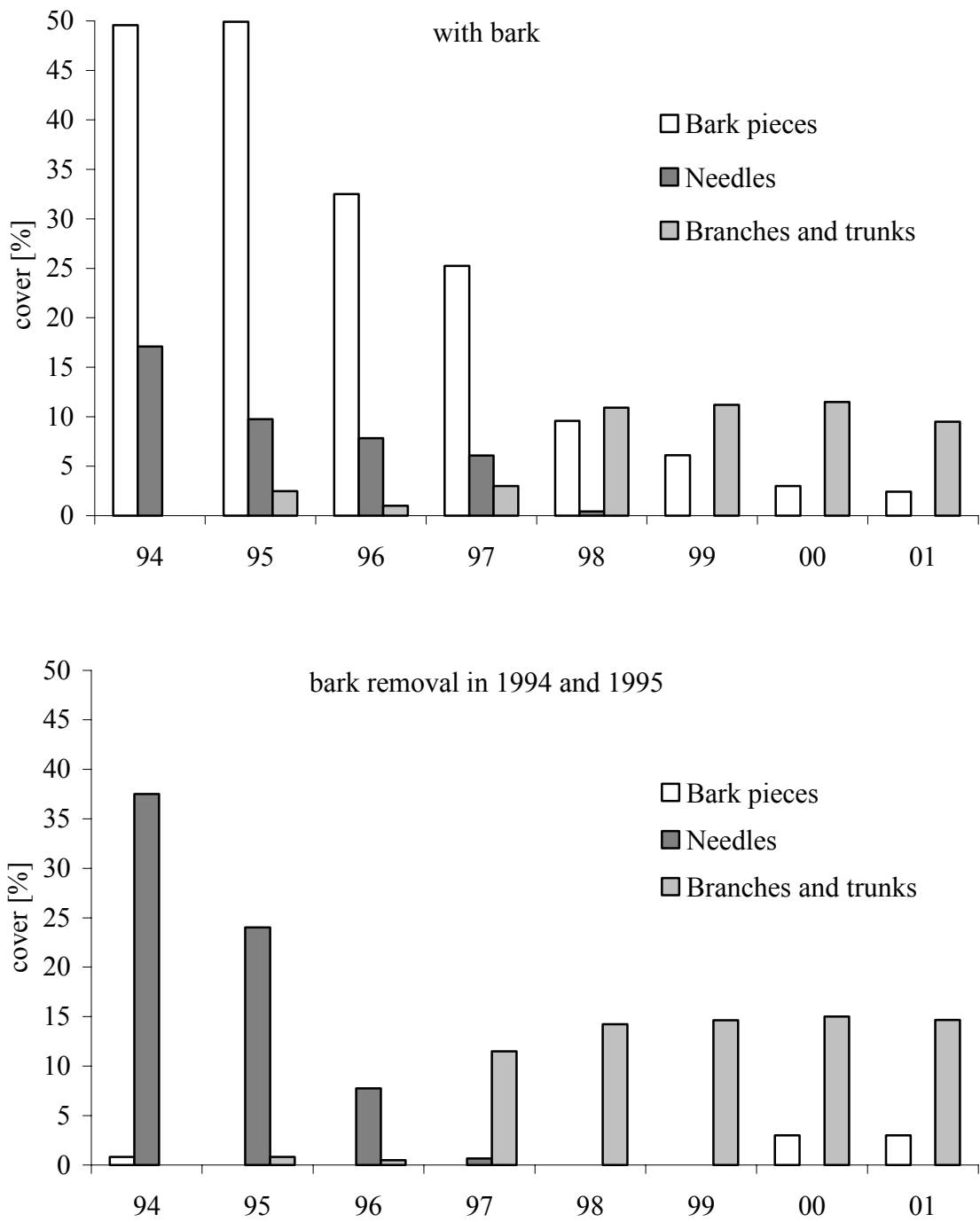

Fig. 2: Ground cover of bark pieces, needles, branches and trunks in the 24 permanent plots. The bark was removed in 1994 and 1995 from 12 plots.

4. Discussion

In the dead *Picea abies* forest on the Gandberg, the ground vegetation changed from a typical forest ground vegetation in 1994 into a *Rubetum idaei* association by 2001. *Rubus idaeus* invaded the stand shortly after the death of the trees, probably by germinating from the soil seed bank and by lateral growth with rhizomes. The seeds of *Rubus* are quite persistent and can be viable after more than 100 years stored in the soil seed bank (Hodgson *et al.* 1995). Moreover, seeds of *Rubus idaeus* are very often transported by birds and game and the ability of seeds to germinate is not reduced by the passage through the stomachs of game (Bonn and Poschlod 1995).

This pattern of succession contrasts that found in the large snag stands of the Bavarian National Park in Germany (Jehl 1995, Reif & Przbylla 1995) and in the Chugach National Forest in south-central Alaska (Holsten *et al.* 1995), where *Rubus idaeus* was almost negligible. However, *Rubus idaeus* established itself after wind-throws in formerly managed mountain forests in Europe (e.g. Copper-Ellis *et al.* 1999, Schoenenberger & Ruesch 1990, Wohlgemuth *et al.* 1995) and in clear-cuts (e.g. Ishizuka *et al.* 1998, Ricard & Messier 1996, Roberts & Dong 1993, Whitney 1982). Therefore I assume that the former forest management (clear-cut in 1842-1846) on the Gandberg has influenced the ground-vegetation succession after tree death.

In our experiment, pieces of bark smothered *Polytrichum formosum* cushions, causing a reduction in the viability of the moss shoots. Due to the rather fast decomposition of bark and not much further litter from fallen bark pieces, the negative influence of the bark-pieces cover, which seemed important in 1994, was limited to a very short period of time. By 2001 differences in the cover had disappeared. In conclusion, bark litter has no long lasting effect on the ground-vegetation succession in a dead, but still standing mountain forest.

Acknowledgement:

I thank Walter Schönenberger for initiating this project and Ulrich Wasem, Isabelle Roth, Sepp Senn, Daniela Csencsics and the forest service of Schwanden for their help during the field work.

5. References

- Bonn S. & Poschod P. (1998): *Ausbreitungsbiologie der Pflanzen Mitteleuropas; Grundlagen und kulturhistorische Aspekte*. UTB, Quelle & Meyer Verlag GmbH & Co., Wiesbaden.
- Carlton G.C. & Bazzaz F.A. (1998): Resource congruence and forest regeneration following an experimental hurricane blowdown. *Ecology* **79**(4): 1305-1319.
- Cooper-Ellis S., Foster D.R., Carlton G. & Lezberg A. (1999): Forest response to catastrophic wind: results from an experimental hurricane. *Ecology* **80**(8): 2683-2696.
- Fischer A.H. (1998): *Die Entwicklung von Wald-Biozönosen nach Sturmwurf*. Ecomed, Landsberg.
- Forstverwaltung Kt. Glarus (1949): Wirtschaftsplan über die Gemeindewaldungen von Schwanden (1. Revision). *Unveröffentlicht*. Forstverwaltung Kt. Glarus, Glarus.
- Hodgson J.G., Grime J.G., Hunt R. & Thompson K. (1995): *The electronic comparative plant ecology*. Chapman & Hall, London.
- Holsten E.H., Werner R.A. & Develice R.L. (1995): Effects of a spruce beetle (Coleoptera: Scolytidae) outbreak and fire on Lutz spruce in Alaska. *Env. Entomol.* **24**(6): 1539-1547.
- Ishizuka M., Toyooka H., Osawa A., Kushima H., Kanazawa Y. & Sato A. (1998): Secondary succession following catastrophic windthrow in a boreal forest in Hokkaido, Japan: The timing of tree establishment. *J. Sust. For.* **6**(3/4): 367-388.
- Jahns H.M. (1995): *BLV Bestimmungsbuch Farne Moose Flechten; Mittel-, Nord- und Westeuropa*. BLV Verlagsgesellschaft mbH, München.
- Jehl H. (1995): Die Waldentwicklung auf Windwurfflächen im Nationalpark Bayerischer Wald. In: Nationalparkverwaltung Bayerischer Wald (ed) *25 Jahre auf dem Weg zum Naturwald*, Neuschönau. 112-146.
- Kaegi B. (1992): Pflanzensoziologische Karte des Gandbergwaldes. *Unveröffentlicht*. Forstdirektion Kt. Glarus, Glarus.
- Lässig R., Egli S., Odermatt O., Schoenenberger W., Stoeckli B. & Wohlgenuth T. (1995): Beginn der Wiederbewaldung auf Windwurfflächen. *Schweiz. Z. Forstwes.* **146**(11): 893-911.
- Lauber K. & Wagner G. (1996): *Flora Helvetica*. Haupt, Bern.
- Peterson C.J. & Pickett S.T.A. (1990): Microsite and elevational influences on early forest regeneration after catastrophic windthrow. *J. Veg. Sci.* **1**: 657-662.
- Reif A. & Przybilla M. (1995): Zur Regeneration der Fichte (*Picea abies*) in den Hochlagen des Nationalparks Bayerischer Wald. *Hoppea* **56**: 467-514.
- Ricard J.-P. & Messier C. (1996): Abundance, growth and allometry of red raspberry (*Rubus idaeus* L.) along a natural light gradient in a northern hardwood forest. *For. Ecol. Manage.* **81**(1): 153-160.
- Roberts M.R. & Dong H. (1993): Effects of soil organic layer removal on regeneration after clear-cutting a northern hardwood stand in New Brunswick. *Can. J. For. Res.* **23**: 2093-2100.
- Schoenenberger W. & Ruesch W. (1990): Wiederbewaldung nach Sturmschäden. *Merkbl. Prax., WSL* **17**: 1-6.

- Sinner K.F. (1999): Aktuelle Konflikte im Nationalpark Bayerischer Wald als Beispiel für unseren gesellschaftlichen Umgang mit Wildnis. *Bayer. Akad. Natursch. Landschaftspfl. Laufener Seminarbeitr.* **2**: 11-13.
- Wermelinger B., Obrist M.K., Duelli P. & Forster B. (1999): Development of the bark beetle (Scolytidae) fauna in windthrow areas in Switzerland. *Mitt. Schweiz. Entomol. Ges.* **72**: 209-220.
- Whitney G.G. (1982): The productivity and carbohydrate economy of a developing stand of *Rubus ideaus*. *Can. J. Bot.* **60**: 2687-2703.
- Wohlgemuth T., Kuhn N., Luescher P., Kull P. & Wuethrich H. (1995): Vegetations- und Bodendynamik auf rezenten Windwurfflächen in den Schweizer Nordalpen. *Schweiz. Z. Forstwes.* **146**(11): 873-891.

III C Development of tree regeneration

Reprint of the published article:

Kupferschmid A.D., Schönenberger W. and Wasem U. (2002): Tree regeneration in a Norway spruce snag stand after tree die-back caused by *Ips typographus*. *For. Snow Landsc. Res.* 77(1/2): 149-160.



Photograph of two *Picea abies* saplings in a permanent plot in the Gandberg forest (plot # 78, 19 October 2000, photograph courtesy of U. Wasem, WSL).

Tree regeneration in a Norway spruce snag stand after tree die-back caused by *Ips typographus*

Andrea D. Kupferschmid, Walter Schönenberger, Ulrich Wasem

Swiss Federal Research Institute WSL, Zürcherstrasse 111, CH-8903 Birmensdorf, Switzerland.
andrea.kupferschmid@wsl.ch; walter.schoenenberger@wsl.ch;
ulrich.wasem@wsl.ch

Abstract

In a managed *Picea abies* mountain forest on Gandberg (northern Swiss Pre-Alps), almost all trees were killed by a European spruce bark beetle outbreak in 1993 and left unharvested. As we assumed the large amount of bark litter would have a negative effect on tree regeneration, we investigated natural tree regeneration in 12 permanent plots after bark removal and in 12 control plots with a bark cover of 50%. In half of the plots, 200 *Picea abies* seeds were sown per plot in 1995.

No advance tree regeneration was present. Three *Picea abies* seedlings m⁻² germinated naturally in 1994. 3.8% of the 2400 sown *Picea* seeds germinated in 1995, resulting in 7.5 seedlings m⁻², with equal numbers in plots with and without bark litter. We assume pieces of bark to have no effect on *Picea* germination. The mortality of naturally germinated *Picea* was 25% each year, regardless the age of the saplings (1-7 year). *Acer pseudoplatanus* saplings were almost as numerous as *Picea* (0.58 m⁻²) in 2001, but pioneer trees such as *Betula pendula* (0.29 m⁻²), *Sorbus aucuparia* (0.16 m⁻²) and *Salix caprea* (0.04 m⁻²) were rare. These low numbers together with extensive ungulate browsing indicate it is unlikely that a closed pioneer or *Acer* stand will be formed. We anticipate that a *Picea* forest will replace the current *Rubus idaeus*-association on the Gandberg.

Keywords

Forest regeneration, snags, *Picea abies*, experimental sowing, seed source.

1. Introduction

Disturbances are important processes in forest dynamics. Disturbances, such as heavy storms, cause direct damage at the level of the forest stand (including complete blowdown) and at the level of the individual tree (e.g. root destabilisation, branch breakage), as well as indirect damage such as bark beetle outbreaks (Forster 1998, Nüsslein and Faisst 1998). An example of such a large disturbance was the wind-storm event ‘Vivian’ in 1990, which struck large parts of Western Europe (BUWAL 1994, Forster 1993). In the following years, large-scale tree die-back of weak *Picea abies* stands, caused by the European spruce bark beetle (*Ips typographus*), occurred (Forster 1993, Wermelinger *et al.* 1999). Given the high cost of tree harvesting in the steep mountains of the Swiss Alps, the question arose whether some of these snag stands could be left unharvested. However, the decision to leave formerly managed forests unharvested after tree death is not without risks (Frey *et al.* 1995). This is particularly the case because little is known about natural tree regeneration in large snag stands (Ross *et al.* 2001).

In interior Alaska, a spruce bark beetle (*Dendroctonus rufipennis* Kirby) epidemic left large snag stands with little natural spruce regeneration (Cole *et al.* 1999). Due to the low levels of spruce regeneration, many of the repeatedly infested areas underwent a forest type conversion (Baker and Kemperman 1974). In the Rocky Mountains, spruce-dominated snag stands which had more than 10% fir changed into fir forests, while other stands with less than 10% fir remained spruce forests (Schmid and Frye 1977). In the steep Swiss Alps natural tree regeneration is also low in dense living spruce forests (Brang and Duc 2002). It is possible that tree regeneration may be even lower in snag stands since the ground becomes quickly covered with large quantities of needles and bark dropped after tree death. Assuming a growing stock of about $880 \text{ m}^3 \text{ ha}^{-1}$ [cf. chapter III A] and a bark thickness of 2 cm, the total bark litter volume of $44 \text{ m}^3 \text{ ha}^{-1}$ would cover about 22% of the soil surface. It is therefore important to establish whether bark litter hinders or promotes tree regeneration.

In the rather flat highlands of the Bavarian National Park in south-eastern Germany, tree regeneration shortly after the death of the Norway spruce trees was found to have slowed down because tree seedlings and saplings were covered by bark litter (Heurich 2001). However, the large deposits of needles ($20 \text{ t dry needles ha}^{-1}$) and bark pieces mulched the zones around the snags and led to an accumulation of nutrients in the soil (Beudert 1999), thus leading to favourable regeneration sites for *Picea* and many ground-vegetation species (Heurich 2001, Sinner 1999). Reif and Przybilla (1995) found 0.28 - 0.82 Norway spruce saplings m^{-2} on sites with bark litter in the Bavarian National Park. However, it is unclear whether bark is also an important factor for tree regeneration in steep mountain forests.

To understand the mechanisms of tree regeneration in a steep snag stand in the Swiss Alps, we investigated the natural tree regeneration and the germination of sown *Picea abies* on plots with varying degrees of bark removal.

2. Materials and Methods

2.1 Study site

The study site is situated on the north face of the Gandstock, south of Schwanden (canton of Glarus, Switzerland) at an elevation of 1220-1260 m a.s.l. The Gandberg inclines towards the North at an angle of about 30-80%, and the site receives no direct sunshine between October and April as a result of orographic shading. Geologically, the Gandberg is composed of red conglomeratic Verrucano (Oberholzer and Heim 1910). The soil is an acid brown soil with a tendency to podsol (Roth 1996). Its depth varies greatly due to the presence of boulders deposited by rockfall. Precipitation and temperature were not recorded directly on the Gandberg site, but nearby in Glarus (470 m) and Linthal/Tierfehd (812 m, MeteoSchweiz data). The estimated mean annual precipitation for the Gandberg forest is 1600-2000 mm and the mean annual temperature 2-3°C. This relatively mild climate is due to the influence of the frequent föhn, a strong, very warm wind from the southern Alps. Since 1548 the Gandberg has been a part of the 102 km² wildlife sanctuary 'Freiberg Kärf'. 680 chamois (*Rupicapra rupicapra*), 173 red deer (*Cervus elaphus*) and 143 roe deer (*Capreolus caprolus*) were present in this area in 1997 (Müller and Zopfi 1999). The Gandberg forest is a main distribution area in summer for chamois (Schmidt 1983).

2.2 Stand structure

The entire Gandberg forest used to be dominated by Norway spruce (*Picea abies*). Only a few silver fir (*Abies alba*, 1%) and sycamore maple (*Acer pseudoplatanus*, 3%) trees were present. The site belongs to the *Galio-Abieti-Piceetum* association (Kägi 1992). The stands developed after being clear-cut in 1842-1846, and were later subject to some high-thinning (Forstverwaltung Kt. Glarus 1949). The forest had a growing stock of about 880 m³ ha⁻¹ in 1990 (Kupferschmid unpublished [but see now chapter III A]) and was dominated by middle-aged timber trees of 35-50 cm dbh. In 1993, a large-scale European spruce bark-beetle (*Ips typographus* L.) outbreak, triggered by the windthrow event Vivian in 1990, caused the death of almost all *Picea abies* trees not only in the Gandberg forest but also in adjacent forests (till 1997 a total area of 100 ha). Only about 2% of the *Picea* trees and all *Abies alba* and *Acer pseudoplatanus* trees survived, scattered throughout the snag stands. In 1994, it was decided to leave the snag

stands unharvested above 1100 m a.s.l., and to actively convert the forest into a deciduous beech forest below this elevation.

In 1992, the ground-vegetation in the Gandberg forest was patchy and dominated by the mosses *Dicranum scoparium*, *Polytrichum formosum* and by *Oxalis acetosella* (Kägi 1992). After *Picea abies* tree death the ground-vegetation changed into a *Rubetum idaei* association (Kupferschmid 2002a). The *Rubus idaeus* had reached a mean height of 150 ± 40 cm and covered 75% of the sites in 2001. Underneath these *Rubus* plants moss covered 40% of the soil surface, *Oxalis acetosella* 25%, fern 28%, *Epilobium angustifolium* and *Rubus fruticosus* 7% (Kupferschmid 2000a).

2.3 Methods

In 1994, we started a pilot experiment with 24 permanent plots of 1 m x 1 m in the montane zone of the Gandberg (1220-1260 m a.s.l.). The plots were at least 1 m away from the next snag or tree stump to prevent unequal shading. The plots were arranged in six main blocks. Each block contained two plots with bark litter and two plots without bark litter (randomised block design with the factor bark removal). In the 12 plots without bark, bark pieces were removed twice a year in 1994 and 1995. 200 *Picea abies* seeds per plot were sown on 8 May 1995 in one plot with and one without bark litter per block (total 12 plots). Seeds were sown at a density of 2 seeds per 10 cm² on bark strips or on the soil surface. The seeds were collected at Kerns, which is located 1460 m a.s.l. and with a North-East inclination, germination ability was 60%. The position and number of establishing tree seedlings and saplings was recorded annually in July/August on a grid map. We measured annual shoot growth and height (the current terminal shoot was not included) of the tree sapling and noted if terminal shoots were browsed. Young trees were classified as seedlings up to the age of one year, and as saplings if they were older than one year with heights shorter than 1.5 m (which is the height of *Rubus*).

Of the ground vegetation only *Polytrichum formosum* and *Oxalis acetosella* were more abundant when bark litter was absent. All the other mosses and herbs had the same cover with or without bark litter (Kupferschmid 2000a). It was therefore not considered necessary to take the ground vegetation into account in analysing the influence of bark litter on tree regeneration. The tree data were analysed after a square root transformation with ANOVA, fitting the factors 'block' and 'bark removal'. Mortality was compared with the Wilcoxon Rank Sum Test for unpaired data (R: Version 1.3.0).

For naming the ground vegetation and tree species we used the nomenclature of Lauber and Wagner (1996); for the mosses that of Jahns (1995); for the herbaceous

plant associations that of Oberdorfer (1993) and for the forest associations that of Ott *et al.* (1997).

3. Results

3.1 Natural tree regeneration

In the 24 permanent plots seeds of six tree species germinated naturally between 1994 and 2001 and the saplings of five species have survived (Fig. 1): *Picea abies* (seedlings N=88, surviving saplings N=13), *Acer pseudoplatanus* (29, 15), *Sorbus aucuparia* (8, 4), *Betula pendula* (8, 7), *Salix caprea* (1, 1) and *Abies alba* (1, 0). There was no advance tree regeneration in any of the plots or in the immediate neighbourhood of the plots, i.e. none of the tree seedlings or saplings were present before the death of the Norway spruce stand.

Picea abies seedlings germinated in 1994 and in 1996 on the Gandberg (Fig. 2), while regional crop years were found in autumn 1992 and 1995 (see discussion). The mortality of the *Picea abies* saplings that germinated in 1994 was 73% in the first five years and 88% in the whole 1994-2001 period (Fig. 4). The mean mortality rate per year was 26% (Fig. 4). Similar results were found for the *Picea abies* saplings that germinated in 1996, with 75% dead by 2001 (first five years) and in average 30% mortality per year. However, in contrast to the 1994 seedlings, the 1996 seedlings had a higher mortality rate (42%) than the saplings in later years (mean of white column 1997-2001 is 27%, see Fig.4). The average height of the 13 surviving *Picea abies* saplings was 13.6 ± 6.8 cm in 2001 (not including the shoot of 2001). The terminal shoots of all but 4 out of 13 living *Picea abies* saplings were browsed in 2001.

Acer pseudoplatanus seedlings were found every year after 1994 (Fig. 3), stemming from some trees that fruited annually in the surrounding area. The mean height of the 15 *Acer pseudoplatanus* saplings was only 10.3 ± 5.6 cm in 2001 due to ungulate browsing.

Betula pendula, on the other hand, was up to 2.3 m high with an average of 143.3 ± 78.6 cm. Surprisingly, the eight *Betula pendula* saplings were only found in plots without bark litter.

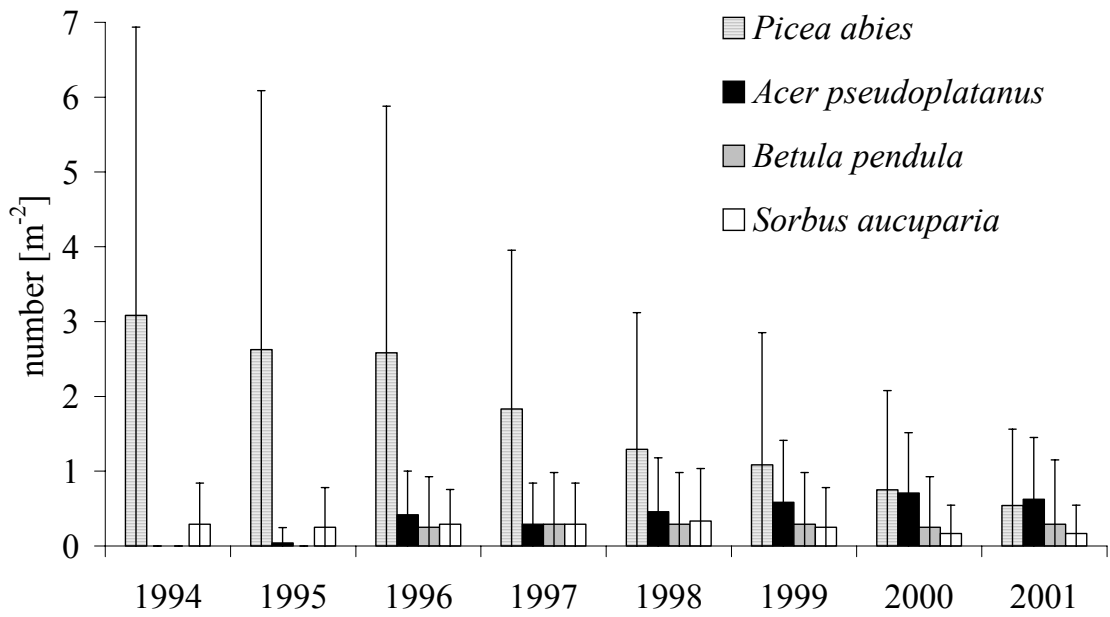

Fig. 1: Mean number \pm standard deviation of naturally germinated and surviving tree seedlings and saplings in all 24 permanent plots from 1994 to 2001.

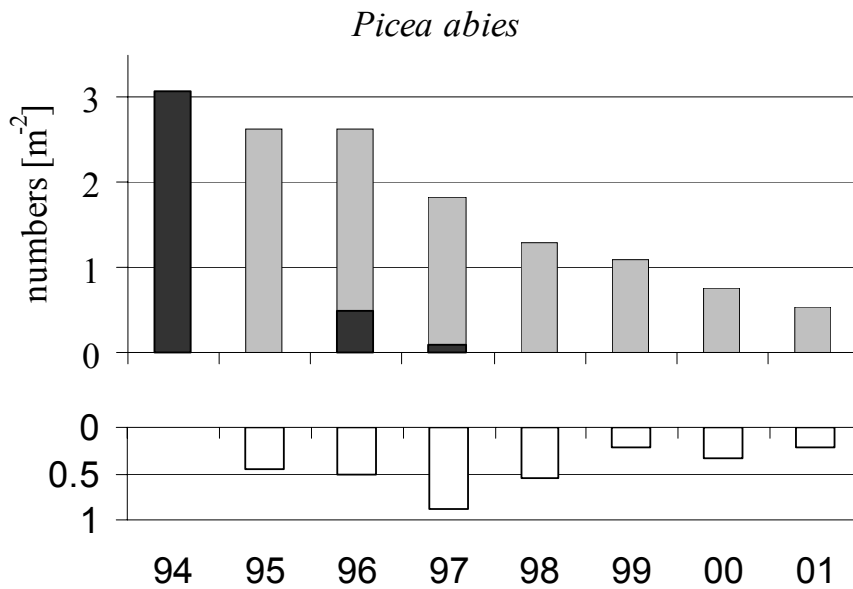

Fig. 2: Number of newly germinated (black), surviving (grey) and dead (white) seedlings and saplings of *Picea abies* in all 24 permanent plots from 1994 to 2001.

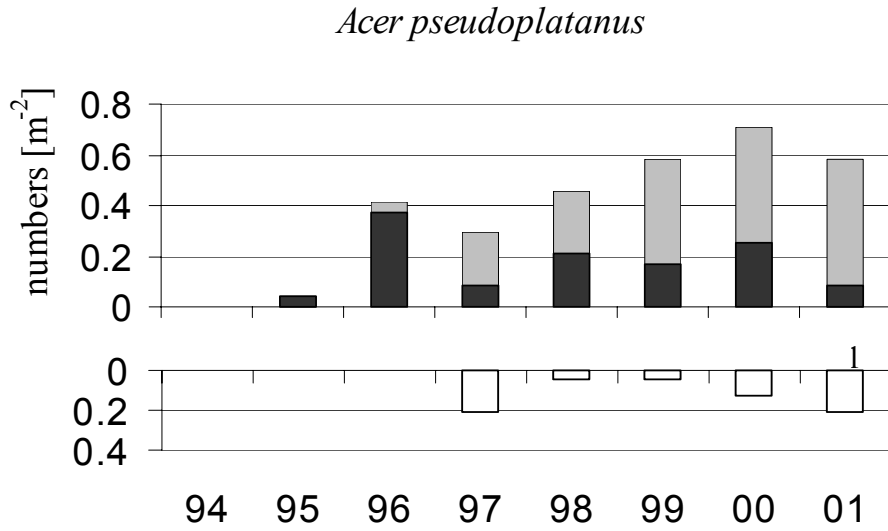

Fig. 3: Number of newly germinated (black), surviving (grey) and dead (white) seedlings and saplings of *Acer pseudoplatanus* in all 24 permanent plots from 1994 to 2001.

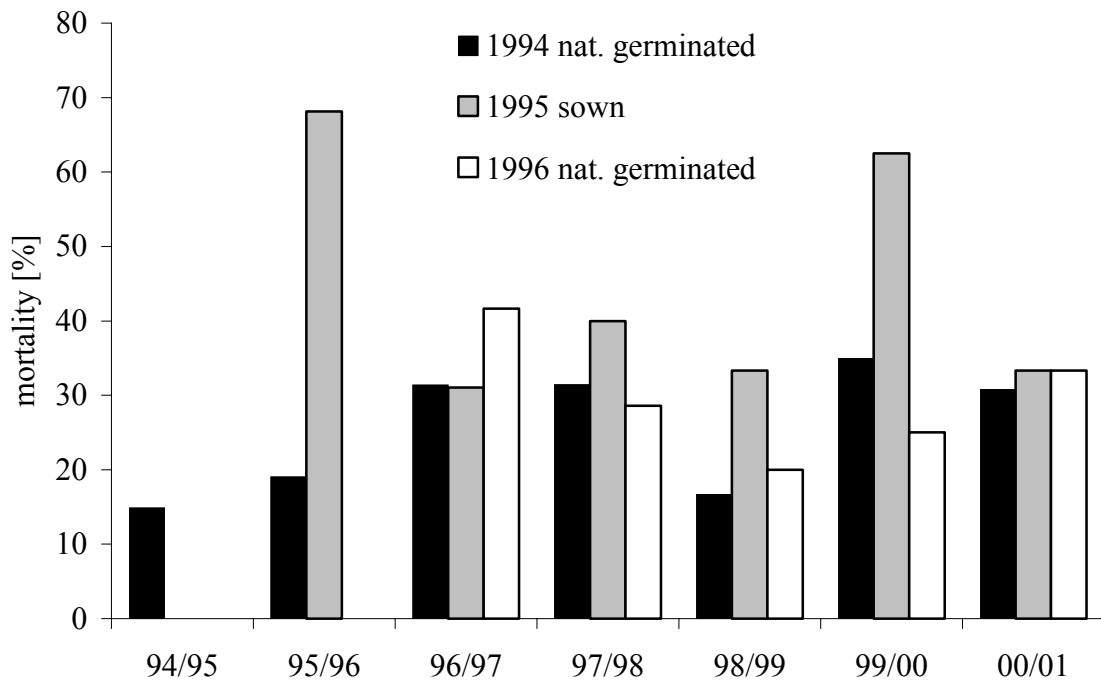

Fig. 4: Mortality of *Picea abies* seedlings and saplings germinated naturally in 1994, after sowing in 1995 or naturally in 1996.

3.2 Sowing experiment

91 of the 2400 *Picea abies* seeds sown in May 1995 germinated and survived until July 1995 (3.8%), resulting in 7.5 ± 4.2 seedlings m^{-2} (Fig. 5). *Picea abies* germinated almost equally well in plots with bark litter (9.1 ± 5.1 seedlings m^{-2}) as in plots without bark litter (6 ± 2.7 seedlings m^{-2} , Fig. 5, ANOVA m.s. = 0.788, $p = 0.327$). However, in the plots with bark litter, only 50% of the soil was actually covered with bark (Fig. 5), therefore the seedlings may have partially germinated on soil rather than on bark. If there is less germination because of bark, there should be fewer seedlings in plots with bark litter than in those without. As we found equal numbers or even slightly more seedlings in plots with bark pieces (Fig. 5), we assume that bark litter does not have a negative effect on *Picea* germination.

In the first months after sowing, the mortality of the sown seedlings (68%) was higher than that of the naturally germinated seedlings (15-42%, Fig. 4, $W = 28.5$, $p < 0.01$). Over the first five years, 97% of the sown *Picea abies* saplings died (Fig. 4), resulting in only 2 surviving saplings in 2001 (Fig. 5). Mortality was therefore higher for sown (97%) than for naturally germinated saplings (74%) in the first five years ($W = 45.5$, $p < 0.01$). Generally, we could not determine the causes of death, although sometimes being covered with pieces of bark may have played a role.

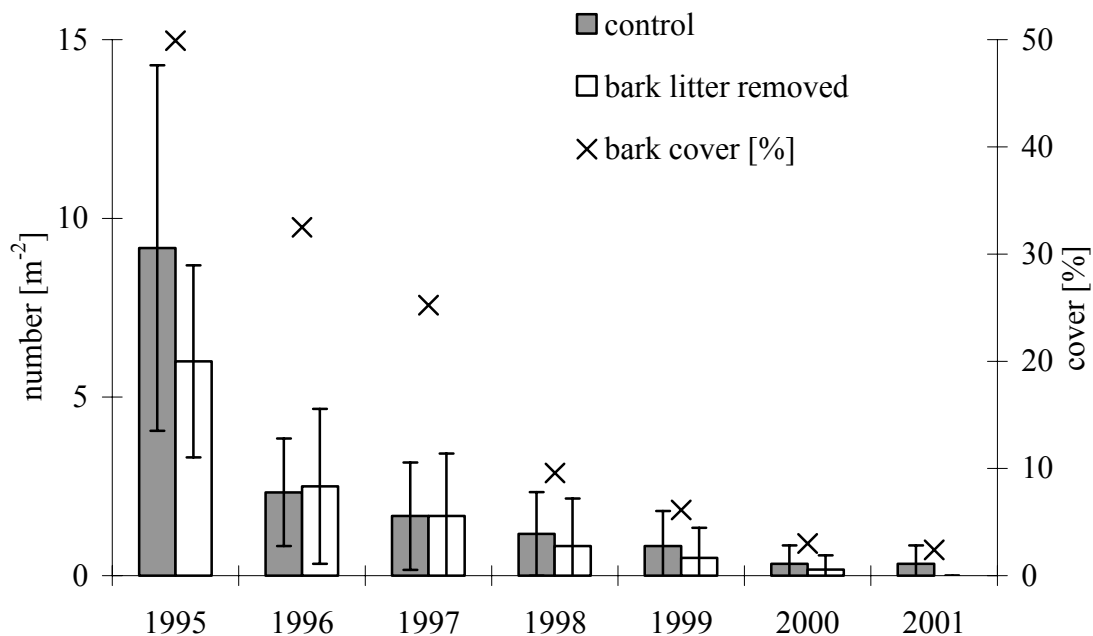

Fig. 5: Mean number \pm standard deviation of germinated and surviving *Picea abies* seedlings and saplings sown in May 1995 on 12 permanent plots with bark removal in 1995 and on 12 control plots. X marks the % mean cover of bark litter (right axis) in the 12 control plots in each year.

4. Discussion

4.1 Development of the snag stand

What plant community will develop on a given site after a spruce beetle infestation depends on several factors including the species that were present on the site before the tree die-back, the distance away from seed sources, the seedbed conditions and the weather conditions after tree death (Ross *et al.* 2001). In our study, the ground vegetation of the former *Picea abies* forest of the Gandberg, which used to be dominated by mosses (i.e. *Polytrichum formosum* and *Dicranum scoparium*) and *Oxalis acetosella*, changed into a *Rubetum idaei* association five years after tree death (Kupferschmid 2002a). The high quantity of needles and bark deposited might have stimulated this succession via nitrogen release in the first years after tree die-back (Beudert 1999). But what vegetation will come after the *Rubetum idaei* association?

Generally, the forest structure prior to disturbance plays an important role in influencing post-disturbance tree succession (e.g. Cooper-Ellis *et al.* 1999). Wind and insect disturbances differ from fire disturbances in the sense that advance regeneration is allowed to survive (Drobyshev 1996). After beetle-caused tree mortality there is often a release of co-dominant or understory trees (Holsten *et al.* 1995, Veblen 1991, Schulz 1996). This depends on the availability of advance regeneration prior to the disturbance, which is often absent in managed forests due to the dense canopy structures (Schönenberger and Wasem 1999). The dense structure of the former *Picea abies* forest on the Gandberg, together with the high pressure from ungulate browsing, explains the lack of advance tree regeneration on the study site.

This initial lack of regeneration can be partially compensated for if new trees rapidly establish. Extrapolating from the numbers found in the permanent plots, it is likely that around 30'000 *Picea* seedlings per ha germinated and survived till July 1994 on the Gandberg. Autumn 1993 was not a crop year in the region, but seed still appears to have dispersed from the fruiting *Picea abies* trees in the neighbouring stands. These neighbouring trees however, also died in 1994 after being attacked by European spruce bark beetles (*Ips typographus*). As a result only 5'000 seedlings ha⁻¹ germinated and survived in 1996, although seed dispersal had presumably been good, as autumn 1995 was an important crop year in the region. Hence, the small quantities of living *Picea* might restrict rapid forest recovery in the Gandberg forest in future, even though at this time decomposed logs would constitute additional niches (Grubb 1977) for new tree regeneration (Mai 1998, Stöckli 1995, Stöckli 1997, Ulanova 2000a). Hogget (2000) found that higher levels of regeneration tend to be associated with higher levels of live canopy trees after a hemlock looper infestation in the interior cedar hemlock biogeoclimatic zone in Canada. Usually, the lack of an adequate seed source near disturbed sites has been attributed in the literature to causing low levels of tree regeneration after disturbances (Lässig *et al.* 1995, Timoney and Peterson 1996).

The few *Acer pseudoplatanus* trees (3%) in the Gandberg forest continued to fruit and hence *Acer* seedlings were found every year in the permanent plots. Our findings support the idea that retaining surviving trees (green tree retention) in disturbed sites and clear-cuttings is important for tree regeneration (Leder and Krumnacker 1998, Beach and Halpern 2001, Hansen *et al.* 1995).

Where rapidly growing, long-lived species such as *Betula sp.* and *Populus sp.* established on a site, *Rubus idaeus* brushwood dominated the site after a disturbance only for 5-10 years (Ricard and Messier 1996, Ulanova 2000b, Whitney 1982). Closed pioneer-crop stands of *Sorbus aucuparia*, *Salix sp.* or *Betula sp.*, are only expected where the advance regeneration of such pioneer tree species is abundant or where large vegetation-free gaps are frequent (Schmidt-Schütz 1999). Neither was the case at our study site on the Gandberg. Therefore, we believe either it will take a very long time for a pioneer tree stand to develop, or no such stand will develop at all. For this reason *Rubus idaeus* will probably continue to dominate the Gandberg snag stands until the *Picea abies* trees have grown so much that they provide too much shade to *Rubus idaeus* and thus *Rubus* will disappear.

4.2 High mortality rates

We observed a mean mortality rate of about 25% per year for naturally germinated *Picea abies* saplings in the permanent plots of the Gandberg (Fig. 4). However, only very few seedlings and saplings were found to have been actually covered by bark, probably because bark decomposed rather fast on the soil surface and because little bark fell after 1995 (Fig. 5). It was not, however, possible to determine directly most of the reasons for the mortality of the tree regeneration. According to other studies, we assume some of the following factors may have played a role in the seedling mortality: (i) the dense ‘canopy’ structure of *Oxalis acetosella* and the frequently dry raw humus on which it grows (Brang 1996); (ii) the horizontally growing mosses like *Hylocomium splendens* and *Thuidium tamariscinum* which inhibit the penetration of seedling roots into the mineral soil layer (Hilaire and Leopold 1995, Hörnberg *et al.* 1997); (iii) the increased shoot growth of *Polytrichum formosum* (Brang 1998) due to more light and nutrients (Potter *et al.* 1995); (iv) the low light availability under *Rubus idaeus* and ferns (Ishizuka *et al.* 1998, Lautenschlager 1999, Starostina 1965 and Ruel 1992); (v) mice activity (Schreiner *et al.* 2000, Odermatt and Wasem 2001, Wasem and Senn 2000); (vi) pathogen attacks, particularly of *Herpotrichia sp.* (Bazzigher 1976); (vii) browsing by ungulates; and (viii) unfavourable weather conditions (Brang 1998) or (ix) a combination of these stress factors.

The sown *Picea abies* had very low germination rates and even higher mortality rates than naturally germinated *Picea*. Seed predation and weather conditions have been

shown to be important factors in influencing the number of germinating seeds (Schreiner *et al.* 2000, Pellissier and Trosset 1992).

Ungulate browsing on tree saplings can cause mortality, but more often shoot reductions have been reported (Eiberle and Nigg 1986, Long *et al.* 1998, Schönenberger and Wasem 1999, Yli-Vakkuri 1961). In windthrow areas Crawford *et al.* (1993) found fewer browsed hemlock trees on mounds than in pits. However, logs were found to be less efficacious as obstacles against chamois (*Rupicapra rupicapra*) than against red deer (*Cervus elaphus*, Lüthi 1998). On our study site on the Gandberg, chamois are very frequent and hence we observed a high browsing pressure even on *Picea abies* (70%). No *Abies alba* survived and *Acer pseudoplatanus* remained small or were lost. Schweiger and Sterba (1997) pointed out that ungulates preferentially browse saplings 10-30 cm high, which corresponds to the actual height of our saplings on the Gandberg. Due to heavy winter feeding by chamois on the tree regeneration, *Rubus idaeus*, which is at this season defoliated, could not play a role in protecting saplings against ungulate browsing. It will therefore probably take many years until the *Rubetum idaei* association currently present on the Gandberg is replaced by a new *Picea abies* forest.

The main question of whether a new *Picea* stand will develop out of the current tree regeneration and how the future stand will be structured is explored in a model we are implementing for this snag stand (Kupferschmid 2002b).

5. Conclusion

Where wind and beetle disturbances are an integral part of forest dynamics, the findings of this study suggest that managers need to be concerned about maintaining stand structures allowing for advance tree regeneration (i.e. allowing more natural development processes (Lässig and Motschalow 2000)). If stands are too dense and homogeneous, there will not be a rapid forest recovery following bark beetle disturbance. Furthermore, retaining the few surviving trees seems to be important for the fast reforestation of disturbed sites, especially if pioneer trees are almost absent. If the management goal is to ensure there is continuous forest cover, pre-disturbance risk management may be even more important than post-disturbance management.

Acknowledgements

We thank Isabelle Roth, Sepp Senn and Daniela Csencsics and the Forest Service of Schwanden for their valuable help during the fieldwork. We are also grateful to the participants at the Seminar of Applied Statistics at the Swiss Federal Institute of Technology in Zürich for their helpful statistical discussions. This work was supported by the Foundation for the Advancement of Forest and Wood Research.

6. References

- Baker B.H. & Kemperman J.A. (1974): Spruce beetle effects on a white spruce stand in Alaska. *J. For.* **72**: 423-425.
- Bazzigher G. (1976): Der schwarze Schneeschimmel der Koniferen (*Herpotrichia juniperi* (Duby) Petak und *Herpotrichia coulteri* (Peck) Bose). *Eur. J. For. Pathol.* **6**: 109-122.
- Beach E.W. & Halpern C.B. (2001): Controls on conifer regeneration in managed riparian forests: effects of seed source, substrate and vegetation. *Can. J. For. Res.* **31**: 471-482.
- Beudert B. (1999): Veränderungen im Stoffhaushalt eines abgestorbenen Fichtenökosystems im Forellenbachgebiet des Nationalparks Bayerischer Wald. In: *Einzugsgebiet Grosse Ohe - 20 Jahre hydrologische Forschung im Nationalpark Bayerischer Wald, Symposiumsbericht*, 11. 5. 1999, Nationalparkverwaltung Bayerischer Wald. 83-106.
- Brang P. (1996): Experimentelle Untersuchungen zur Ansamungsökologie der Fichte im zwischenalpinen Gebirgswald. *Beih. Schweiz. Z. Forstwes.* **77**.
- Brang P. (1998): Early seedling establishment of *Picea abies* in small forest gaps in the Swiss Alps. *Can. J. For. Res.* **28**: (4): 626-639.
- Brang P. & Duc P. (2002): Zu wenig Verjüngung im Schweizer Gebirgs-Fichtenwald: Nachweis mit einem neuen Modellansatz. *Schweiz. Z. Forstwes.* **153**(6): 219-227.
- BUWAL (1994): Sturmschäden 1990 im Schweizer Wald. *Bundesamt für Umwelt, Wald und Landschaft*, Bern.
- Cole E., Newton M. & Youngblood A. (1999): Regeneration white spruce, paper birch and willow in south-central Alaska. *Can. J. For. Res.* **29**(7): 993-1001.
- Cooper-Ellis S., Foster D.R., Carlton G. & Lezberg A. (1999): Forest response to catastrophic wind: results from an experimental hurricane. *Ecology* **80**(8): 2683-2696.
- Crawford H.S., Lautenschlager R.A., Stokes M.R. & Stone T.L. (1993): Effects of forest disturbance and soil depth on digestible energy for moos and white-tailed deer. *USDA Forest Service Research Paper NE-682*.
- Drobyshev I.V. (1996): Role of natural disturbances in regeneration of Norway spruce in different types of European south boreal forests. In: Yves Bergeron & Gilles Frisque (eds.), *Second International Workshop on Disturbance Dynamics in Boreal Forest*, Rouyn-Noranda, Québec, Canada, August 1996: Workshop abstracts. Université de Québec, Québec, 75-78.

- Eiberle K. & Nigg H. (1986): Untersuchung über den Verbiss durch die Gemse (*Rupicapra rupicapra* L.) an Fichte (*Picea abies*). *Ber. Bot.-Zool. Ges. Liecht.-Sargans-Werdenberg* **15**: 15-36.
- Forster B. (1993): Entwicklung der Borkenkäfersituation in den Schweizer Sturmschadengebieten. *Schweiz. Z. Forstwes.* **144**(10): 767-776.
- Forster B. (1998): Storm damages and bark beetle management: how to set priorities. In: *IUFRO Workshop; Methodology of Forest Insect and Disease Survey in Central Europe*, 7.03.10, Ustron - Jaszowiec (Poland). 161-165.
- Forstverwaltung Kt. Glarus (1949): Wirtschaftsplan über die Gemeindewaldungen von Schwanden (1. Revision). *Unveröffentlicht*. Forstverwaltung Kt. Glarus, Glarus.
- Frey W., Forster B., Gerber W., Graf F., Heiniger U., Kuhn N. & Thee P. (1995): Risiken und Naturgefahren auf Windwurfflächen. *Schweiz. Z. Forstwes.* **146**(11): 863-872.
- Grubb P.J. (1977): The maintenance of species richness in plant communities: the importance of the regeneration niche. *Biol. Rev.* **52**: 107-145.
- Hansen A.J., Garman S.L., Weigand J.F., Urban D.L., McComb W.C. & Raphael M.G. (1995): Alternative silvicultural regimes in the Pacific Northwest: simulations of ecological and economic effects. *Ecol. Applic.* **5**(3): 535-554.
- Heurich M. (2001): Waldentwicklung im montanen Fichtenwald nach grossflächigem Buchdruckerbefall im Nationalpark Bayerischer Wald. In: Marco Heurich (ed.), *Waldentwicklung im Bergwald nach Windwurf und Borkenkäferbefall. Nationalparkverwaltung Bayerischer Wald*, Grafenau, 99-176.
- Hilaire L.R.S. & Leopold D.J. (1995): Conifer seedling distribution in relation to microsite conditions in a central New York forested minerotrophic peatland. *Can. J. For. Res.* **25**: 261-269.
- Hogget A. (2000): Western hemlock looper and forest disturbance in the ICHwk3 of the Robson Valley; Stage 2: The Effects of western hemlock looper - Report and silviculture recommendations. Faculty of Forestry, University of British Columbia.
- Holsten E.H., Werner R.A. & Develice R.L. (1995): Effects of a spruce beetle (*Coloptera: Scolytidae*) outbreak and fire on Lutz spruce in Alaska. *Env. Entomol.* **24**(6): 1539-1547.
- Hörnberg G., Ohlson M. & Zackrisson O. (1997): Influence of bryophytes and microrelief conditions on *Picea abies* seed regeneration patterns in boreal old-growth swamp forests. *Can. J. For. Res.* **27**: 1015-1023.
- Ishizuka M., Toyooka H., Osawa A., Kushima H., Kanazawa Y. & Sato A. (1998): Secondary succession following catastrophic windthrow in a boreal forest in Hokkaido, Japan: The timing of tree establishment. *J. Sust. For.* **6**(3/4): 367-388.
- Jahns H.M. (1995): BLV Bestimmungsbuch Farne Moose Flechten; Mittel-, Nord- und Westeuropa. *BLV Verlagsgesellschaft mbH*, München.
- Kägi B. (1992): Pflanzensoziologische Karte des Gandbergwaldes. *Unveröffentlicht*. Forstdirektion Kt. Glarus, Glarus.
- Kupferschmid A.D. (2002a): Bark influence on vegetation development in a dead *Picea abies* mountain forest. In: Roberta Bottarin & Ulrich Tappeiner (eds.) *Conference Proceedings Interdisciplinary mountain research*, Blackwell Science. 210-215.
- Kupferschmid A.D. (2002b): Decay and regeneration of a Norway spruce mountain forest after a large-scale die-back caused by bark beetles in the northern Swiss

- Alps. Internet: <<http://www.wsl.ch/staff/andrea.kupferschmid/Gandbergen.html>>. Last update 10 Jan. 2002.
- Lässig R., Egli S., Odermatt O., Schönenberger W., Stöckli B. & Wohlgemuth T. (1995): Beginn der Wiederbewaldung auf Windwurfflächen. *Schweiz. Z. Forstwes.* **146**(11): 893-911.
- Lässig R. & Motschalow S.A. (2000): Frequency and characteristics of severe storms in the Urals and their influence on the development, structure and management of the boreal forests. *For. Ecol. Manage.* **135**: 179-194.
- Lauber K. & Wagner G. (1996): *Flora Helvetica*. Haupt, Bern.
- Lautenschlager R. (1999): Environmental resource interactions affect red raspberry growth and its competition with white spruce. *Can. J. For. Res.* **29**(7): 906-916.
- Leder B. & Krumnacker J. (1998): Zur Vegetations- und Gehölzentwicklung auf Sukzessionsflächen nach Fichtenwindwurf. *LÖBF-Mitt.* **1**: 64-72.
- Long Z.T., Peterson C.J. & Carson W.P. (1998): Can disturbance create refugia from herbivores: an example with hemlock regeneration on treefall mounds. *J. Torrey Bot. Soc.* **125**(2): 165-168.
- Lüthi C. (1998): Einfluss verschiedener Räumungsvarianten auf die Nutzung der ehemaligen Sturmschadenfläche Schwanden durch Schalenwild. *Diplomarbeit*, Institut für Forstwissenschaften, ETH, Zürich.
- Mai W. (1998): Naturverjüngung auf Moderholz. *AFZ/Wald* **11**: 591.
- Nüsslein S. & Faisst G. (1998): Waldentwicklung im Nationalpark Bayerischer Wald 1998: Totholzflächen und Waldverjüngung. *Bayerische Landesanstalt für Wald und Forstwirtschaft*, Freising.
- Oberdorfer E. (1993): *Süddeutsche Pflanzengesellschaften, Teil II: Sand- und Trockenrasen, Heide- und Borstgrasgesellschaften, alpine Magerrasen, Saum-Gesellschaften, Schlag- und Hochstauden-Fluren*. Gustav Fischer Verlag, Jena.
- Oberholzer J. & Heim A. (1910): *Geologische Karte der Glarneralpen 1:50'000*. (Spezialkarte Nr. 50), Schweiz. Geol. Kommission, Kartographia AG, Winterthur.
- Odermatt, O. & Wasem U. (2001): Mäuseschäden bei der Wiederbewaldung von Windwurfflächen. Internet: <<http://www.wsl.ch/forest/wus/pbmd/>>. Last update 28 Nov. 2002. 3 pp. [pdf]
- Ott E., Frehner M., Frey H.-U. & Lüscher P. (1997): *Gebirgsnadelwälder: Ein praxisorientierter Leitfaden für eine standortgerechte Waldbehandlung*. Verlag Paul Haupt, Bern, Stuttgart, Wien.
- Pellissier F. & Trosset L. (1992): Les difficultés de régénération naturelle des pessières subalpines: prédation des graines au sol et blocages dus à l'humus. *Ann. sci. for.* **49**: 383-388.
- Potter J.A., Press M.C., Callaghan T.V. & Lee J.A. (1995): Growth responses of *Polytrichum commune* and *Hylocomium splendens* to simulated environmental change in the sub-arctic. *New Phytol.* **131**: 553-541.
- Reif A. & Przybilla M. (1995): Zur Regeneration der Fichte (*Picea abies*) in den Hochlagen des Nationalparks Bayerischer Wald. *Hoppea* **56**: 467-514.
- Ricard J.-P. & Messier C. (1996): Abundance, growth and allometry of red raspberry (*Rubus idaeus* L.) along a natural light gradient in a northern hardwood forest. *For. Ecol. Manage.* **81**(1): 153-160.
- Ross D.W., Daterman G.E., Boughton J.L. & Quigley T.M. (2001): Forest health restoration in south-central Alaska: a problem analysis. *Gen. Tech. Rep. USDA For. Serv. PNW-GTR-523*: 1-38.

- Roth I. (1996): Untersuchungen über die forstliche Ansamung in einem abgestorbenen Fichtenbestand, Objekt: Gandberg oberhalb Schwanden GL. *Diplomarbeit*, Departement Wald- und Holzforschung. ETH, Zürich.
- Ruel J.-C. (1992): Impact de la compétition exercée par le framboisier (*Rubus idaeus* L.) et les feuillus de lumière sur la croissance du sapin (*Abies balsamea* (L.) Mill.) en régénération. *Can. J. For. Res.* **22**(9): 1408-1416.
- Schmid J.M. & Frye R.H. (1977): Spruce beetles in the Rockies. *U.S. Dep. Agric. For. Serv. Gen. Tech. Rep. RM - 49*:1-38
- Schmidt A. (1983): *Der Freiberg Kärf; Das älteste Wildschutzgebiet der Schweiz in den Glarner Alpen*. Buchhandlung Baeschlin, Glarus.
- Schmidt-Schütz A. (1999): Wiederbewaldung von Fichten-Sturmwurfflächen auf vernässenden Standorten mit Hilfe von Pioniergehölzen. *Forstl. Forsch.ber.* München, **176**: 120-130.
- Schönenberger W. & Wasem U. (1999): Der Beginn der Wiederbewaldung von Sturmwurfflächen im Gebirge - Ein Zwischenbericht. *Forstl. Forsch.ber.* München, **176**: 102-110.
- Schreiner M., Bauer E.-M. & Kollmann J. (2000): Reducing predation of conifer seeds by clear-cutting *Rubus fruticosus* agg. in two montane forest stands. *For. Ecol. Manage.* **126**(3): 281-290.
- Schulz B. (1996): Response of residual spruce in beetle-impacted stands in Resurrection Creek Drainage, Kenai Peninsula, Alaska. *USDA Forest Service Technical Report-62*. 21p.
- Schweiger J. & Sterba H. (1997): A model describing natural regeneration recruitment of Norway spruce (*Picea abies* (L.) Karst.) in Austria. *For. Ecol. Manage.* **97**(2): 107-118.
- Sinner K.F. (1999): Aktuelle Konflikte im Nationalpark Bayerischer Wald als Beispiel für unseren gesellschaftlichen Umgang mit Wildnis. *Bayer. Akad. Natursch. Landschaftspfl.* Laufener Seminarbeitr. **2**: 11-13.
- Starostina K.F. (1965): Experimental data on the effect of *Rubus idaeus* on the growth of *Picea abies* seedlings on clear fellings. *Bot. Zurn. Leningrad* **50**(7): 971-974.
- Stöckli B. (1995): Moderholz für die Naturverjüngung im Bergwald: Anleitung zum Moderanbau. *Merkbl. f. d. Praxis, WSL* **26**: 8-14.
- Stöckli B. (1997): Moderholzverjüngung, Hilfsmassnahme zur Kadaververjüngung. *AFZ/Wald* **2**: 85.
- Timoney K.P. & Peterson G. (1996): Failure of natural regeneration after clearcut logging in Wood Buffalo National Park, Canada. *For. Ecol. Manag.* **87**(1-3): 89-105.
- Ulanova N.G. (2000a): The effects of windthrow on forests at different spatial scales: a review. *For. Ecol. Manage.* **135**: 155-167.
- Ulanova N.G. (2000b): Plant age stages during succession in woodland clearings in Central Russia. In: *Proceedings IAVS Symposium*. I.A.V.S. Opulus Press Uppsala, Schweden. 80-83.
- Veblen T.T., Hadley K.S., Reid M.S. & Rebertus A.J. (1991): The response of subalpine forests to spruce beetle outbreak in Colorado. *Ecol.* **72**: 213-231.
- Wasem U. & Senn, J. (2000): Fehlende Weisstannenverjüngung: Hohe Schalenwildbestände können die Ursache sein. *Wald Holz* **9**: 11-14.

- Wermelinger B., Obrist M.K., Duelli P. & Forster B. (1999): Development of the bark beetle (Scolytidae) fauna in windthrow areas in Switzerland. *Mitt. Schweiz. Entomol. Ges.* **72**: 209-220.
- Whitney G.G. (1982): The productivity and carbohydrate economy of a developing stand of *Rubus ideaus*. *Can. J. Bot.* **60**: 2687-2703.
- Yli-Vakkuri P. (1961): Kokeellisia tutkimuksia taimien sytymisestä ja ensi kehityksestä kuusikoissa ja männiköissä (Experimental studies on the emergence and initial development of tree seedlings in spruce and pine stands). *Acta For. Fenn.* **75**: 1-122.

IV LONG-TERM SUCCESSION

IV A Review of forest succession models with special regard to tree regeneration

Forest succession models are often used to analyze and synthesize field data. Notably, such models represent formalizations and abstractions of the processes operating in nature. Like in caricatures, a succession model is not a mirror of reality, but an attempt to reproduce the most important features, e.g. stages and processes, in the simplest possible manner. Therefore, a succession model is never a complete representation of succession in nature, but it is designed to describe, quantify and reproduce selected successional processes.

In the specific context of the present thesis, tree regeneration is the core component for capturing forest succession in a model. When such a tree regeneration model is described mathematically, simulation experiments can be performed to evaluate in which direction natural regeneration would evolve, assuming that the conditions on which the model is based are maintained in the future. A model-based approach can therefore help to detect at an early successional stage whether there are problems with respect to the amount and size of tree regeneration in the Gandberg protection forest.

This chapter is structured in 4 sections:

1. A short overview of different approaches to model forest succession is given. In doing so, the main features that are required to simulate growth and mortality are described briefly, and selected tree regeneration models are presented in some detail.
2. The specific requirements for simulating tree regeneration dynamics in the snag stands of the Gandberg in the Swiss Alps are outlined.
3. The various model approaches reviewed in section 1 are evaluated to select the most suitable model with respect to simulating tree regeneration in the snag stands on the Gandberg. Specifically, the disadvantages of some existing models will be discussed with regard to the problem of simulating tree regeneration in mountain forests.
4. Based on this review, the strategy for implementing a new tree regeneration model is explained, and a short outlook regarding the selected model approach is given. The structure and other details of the model ‘RegSnag’ (i.e., ‘Regeneration in a Snag stand’) are explained in chapters IV B and IV C of this thesis.

In the present chapter, young trees were classified as seedlings up to the age of one year, and as saplings if they were older than one year, but not yet a pole. The term ‘small saplings’ is used to denote saplings with heights shorter than 1.3 m (= saplings according to the definition in chapter III C) and ‘tall saplings’ for trees taller than 1.3 m, but not yet in the pole stage (smaller than about 10 cm dbh). The terms ‘tree ingrowth’ or ‘tree recruitment’ are used for trees that have entered a certain stage or category in a model or in reality (as defined in IUFRO 1990).

1. Overview of forest succession models

Several reviews of forest succession models exist: (1) general reviews (Hasenauer *et al.* 2000, Pretzsch 2001, Benz 2003), (2) reviews of special groups of succession models (e.g., gap models, Liu and Ashton 1995, Bugmann 2001) or (3) reviews of processes in such model groups (e.g., mortality (Keane *et al.* 2001) and tree regeneration (Price *et al.* 2001) in gap models). The classification schemes that can be used are manifold (Vanclay 1994, Vanclay 1995, Lischke 2001, Porté and Bartelink 2002). The allocation of models to one particular class is not always easy and unequivocal because many models represent mixtures of several approaches. However, classification schemes help to elucidate and compare different approaches.

According to Porté and Bartelink (2002), it is important to distinguish between (i) the size of the organisation levels (i.e. the smallest unit identified) in the models, (ii) the spatial explicitness of a model and (iii) the heterogeneity of the objects in the models. For example, different succession models simulate entire stands, groups of species, cohorts of trees, or individual trees. Often, different approaches are used to model mature trees vs. small tree saplings (e.g. section forest management simulators). In some models, each tree has an exact horizontal position within a stand; such models are therefore called ‘distance-dependent tree models’ (e.g. Erni and Lemm 1995). In other models, the location of trees within a patch is not known, but the patches themselves have a specified position in the stand (e.g. Lexer and Hönninger 2001). In still other models, neither trees nor patches have a known spatial location, i.e. these models are ‘distance-independent’ (e.g. Buongiorno and Michie 1980, Bugmann 1994).

Furthermore, ‘descriptive’ or ‘empirical’ models can be distinguished from ‘process-based’ or ‘mechanistic’ models. In empirical models, the biological, physical and chemical processes are not modelled, but the responses of trees to these conditions are treated using statistical relationships, often (but not always) based on field data (e.g. matrix models). In fully mechanistic, process-based models, all the biological, physical and chemical processes would need to be included. In most models, however, a combination of these two approaches is used (e.g. gap models).

Since there are so many different approaches for modelling forest succession, only the major approaches are described here, which include:

1. Gap models and hybrid models (mix of gap models and more mechanistic models)
2. Size class models
3. Forest management simulators

This classification incorporates aspects of those proposed by Hasenauer *et al.* (2000) and Porte and Bartelink (2002), but in the details it differs from both of them. Models are assigned to one of these groups according to the approach taken for modelling mature trees (Fig.1).

1.1 Gap models and hybrid models

1.1.1 Gap models

Gap models were originally constructed for simulating species succession at the level of the individual tree. They have been widely and successfully used for simulating forest succession (e.g. Botkin *et al.* 1972, Kienast and Kräuchi 1991, Lexer *et al.* 2002, Lischke *et al.* 2002), but also grassland succession (e.g. Humphries *et al.* 1996, Goslee *et al.* 2001, Hochstrasser *et al.* 2002, Peters 2002). The primary focus is on simulating forest succession under different climatic conditions, by describing stand biomass and species composition over centuries (e.g. Prentice *et al.* 1993, Bugmann 1994, Fischlin *et al.* 1995, Shao *et al.* 1995).

In gap models (also called ‘patch models’, e.g. Lexer and Hönninger 2001), the establishment, growth and mortality of individual trees are simulated on small patches of land as a function of biotic (competition) and abiotic factors (climate and soil). JABOWA (named after the tree authors Janak, Botkin and Wallis, Botkin *et al.* 1972), the first gap model, was based on the following assumptions (Bugmann 2001):

- The forest is abstracted as a composite of many small patches of land, of which each can have a different age and successional stage. The size of the patch is chosen so that a large individual organism can dominate the entire patch; in the model JABOWA, patch size is thus 10 x 10 m².
- Successional processes can be described on each of those patches separately, i.e. there are no interactions between patches, and the forest is a mosaic of independent patches.
- Patches are horizontally homogeneous, i.e. tree position within a patch is not considered. A consequence of this assumption is that all tree crowns extend horizontally across the entire patch.

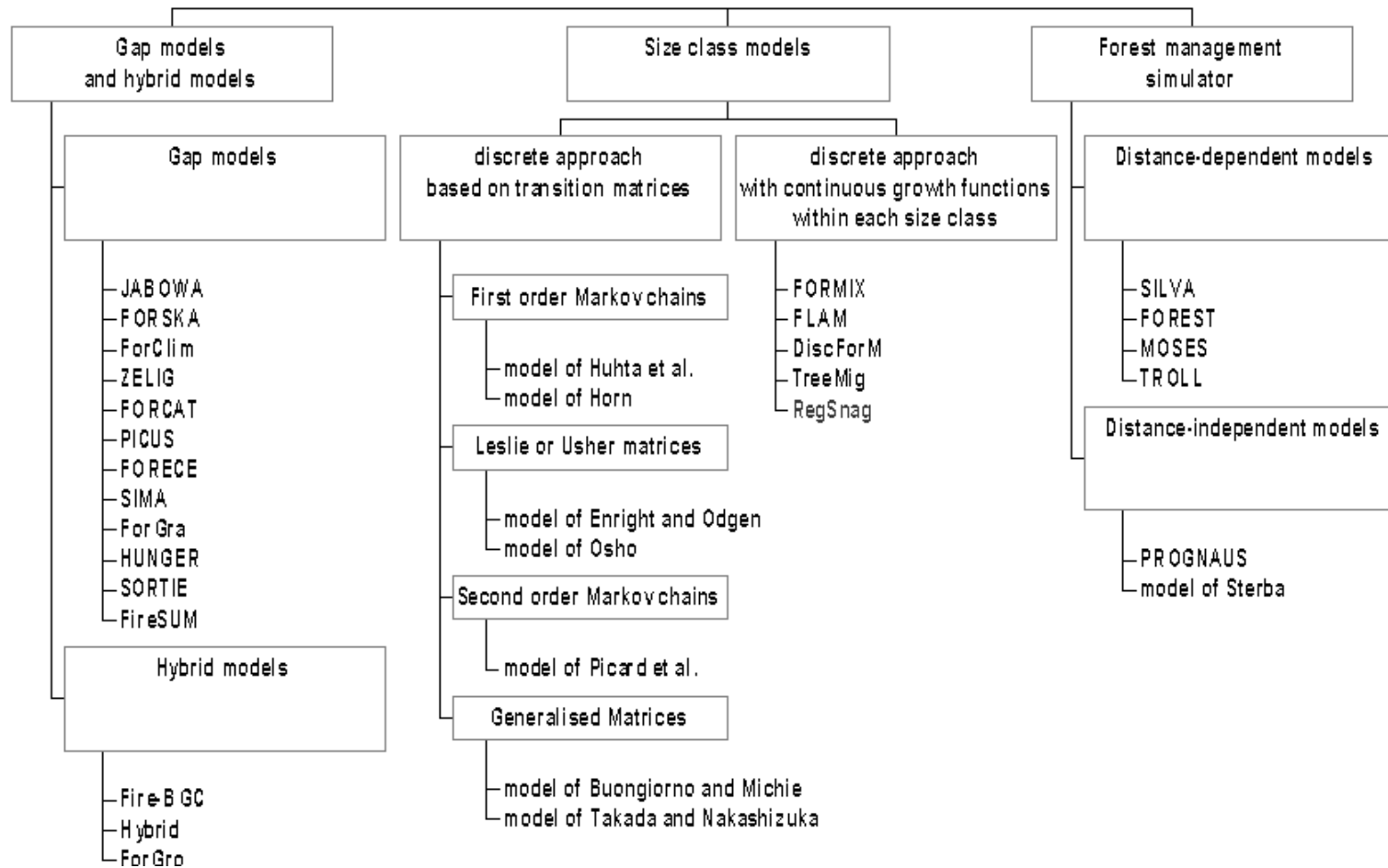

Fig. 1: Classification scheme of models of forest dynamics, including the models that are discussed in this chapter and the model RegSnag, which is discussed in chapter IV C.

- The leaves of each tree are located in an indefinitely thin layer (disk) at the top of the stem.
- Seeds of all species are always present, i.e. all species are supposed to dispose of an infinite seed source on the patches.
- Growth is modelled as a deterministic process, but mortality and regeneration are stochastic processes.
- Competition between trees and other life forms such as shrubs, herbs, or grasses can be ignored.

Since the development of the JABOWA model, many other gap models have been created with considerable variations, but the general principles underlying JABOWA usually remained the same. Most gap models are composed of three submodels: tree establishment, mortality and growth.

Growth

The growth function of gap models is based on the growth potential of a tree; this is a similar concept as in some forest management simulators. However, in gap models the growth potential is defined as the maximum diameter increment a tree species can achieve, independent of site quality. This maximum potential is then reduced by ‘response functions’ which depend on light, temperature, moisture and – to some extent – on nutrients. These features are site- and species-specific. Diameter increment in gap models is simulated for each tree, or for tree cohorts, for example according to Botkin *et al.* (1972) with the following equation:

$$\frac{d(dbh^2 * h)_{\max}}{dt} = R * LA * \left(1 - \frac{dbh * h}{dbh_{\max} * h_{\max}} \right) \quad (1)$$

where R is a growth parameter (derived from a photosynthesis rate parameter), LA is leaf area, dbh is diameter at breast height, and h is tree height, which is calculated according to equation 2 (cf. Fig. 2):

$$h = 137 + b * dbh + c * dbh^2, \quad (2)$$

$$\text{where } b = \frac{2 * (h_{\max} - 137)}{d_{hb}_{\max}} \text{ and } c = \frac{-b}{2 * d_{hb}_{\max}}$$

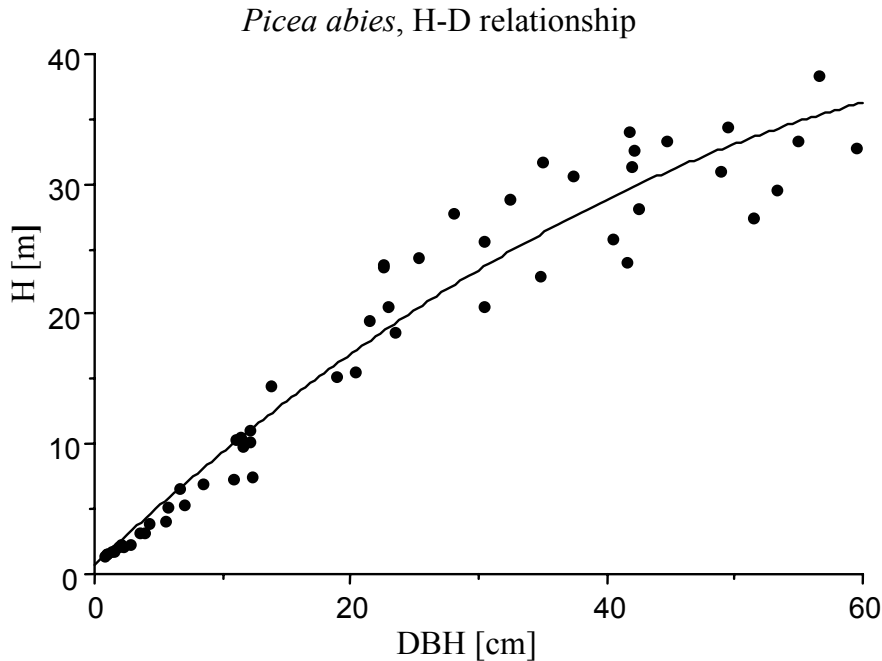

Fig. 2: Example of the height function in the gap model ForClim (Bugmann 1994): Points represent field data originating from Burger (Burger 1952, 1953), and the line corresponds to a polynomial regression line fitted with equation 2.

Mortality

Mortality in gap models is normally separated into two different types: (i) an intrinsic, constant background mortality that allows only a small percentage of the trees to survive to their species-specific maximum age; and (ii) a stress-related mortality that acts when annual diameter increment is lower than a certain minimum increment for any given year and species (Bugmann 2001). For example, in the model SORTIE the intrinsic constant mortality is 1% per year (Pacala *et al.* 1996) and the stress-related mortality (m) is dependent on the individual tree growth rate (g) during the previous five years (e.g. $m = a * e^{-bg}$, where a and b are species-specific parameters, Kobe *et al.* 1995). Therefore, as radial growth of the trees increases with tree size, the mortality decreases in the model. Lindner *et al.* (1997) found that this stress-induced mortality was overestimated for suppressed trees in the model FORSKA, and therefore the simulated mortality was too high compared with field data extending from 1870 to 1990. In a number of case studies in the Swiss Alps, Wehrli (personal communication) also found that the stress-related mortality in the model ForClim was unrealistically high, making it difficult for suppressed *Picea abies*, *Pinus cembra* and *Acer pseudoplatanus* trees to grow in their simulated stands, and hence allowing no understory. Generally, little attention has been paid in gap models to simulate tree

mortality more accurately because of sparse data on the causal mechanisms of mortality (for a review see Keane *et al.* 2001).

Tree establishment

In gap models, tree ingrowth is influenced by light availability at the forest floor and other environmental conditions (e.g. soil moisture, nitrogen, temperature, browsing). In most gap models, tall tree saplings are ‘planted’ with a dbh that is constant (about 0.5 – 1.5 cm) or determined randomly from a pre-defined dbh range, if the climatic (e.g. absolute minimum winter temperature, summer temperature sum, soil humidity) and biotic conditions (e.g. light availability, game pressure) are met for a specific tree species at a given site in time. The consequence is that new saplings of about 2-3 m height pop up when these conditions are fulfilled. The fact that establishment of trees up to this height may be difficult in reality is taken into account in the models simply by reducing the establishment probability of these tall saplings to a small percentage, e.g. maximum 10% (i.e., 90% sapling mortality, Bugmann 1994). Therefore, no tree seedling and small sapling is modelled in most gap models, but only ingrowth into the stage of tall saplings. Growth and mortality of tall tree saplings are simulated with the methods used for mature trees (see above).

1.1.2 Hybrid models

Other distance-independent models that simulate each tree individually include a more mechanistic approach than gap models, i.e. they are process-oriented tree models. Particularly, they simulate tree growth based on a consideration of photosynthesis, respiration and allocation. Such physiologically based carbon-balance models describe the flow of water, carbon and nutrients in the forest ecosystem (Mohren and Vandeveen 1995, Keane *et al.* 1996, Friend *et al.* 1997). For example, processes that are included in the model ForGro (= forest growth model) are photosynthesis and respiration, phenology, hydrology (detailed and partly empirical), nutrient cycling (mechanistic), forest growth (detailed and partly empirical), and forest structure development (Mohren and Vandeveen 1995).

The model Fire-BGC is a highly complex, individual tree-based model that was developed by merging the gap model FireSUM with the mechanistic model Forest-BGC, which is mostly process-based (Keane *et al.* 1996). The model Fire-BGC includes seed dispersal and tree establishment, growth and mortality of individual trees across entire landscapes. The occurrence of an abundant cone crop is determined stochastically for each tree species at the landscape level. Then, the probability of seed input by species is computed for every grid cell of the landscape. New trees of a species establish on a grid cell if several environmental criteria are met (including spring frost, fall frost, water stress criteria, and time after a stand disturbance by fire). The number of trees

which actually establish on the grid cell for any species, i.e. tree ingrowth, is calculated as a reduction of a maximum establishment rate using four scalars that indirectly represent environmental effects on tree species. These scalars are (i) the effect of duff and litter depth on tree seedling survival, (ii) the effect of shading, (iii) an index for crowding (competition for space) and (iv) the probability of seeds arriving at the grid cell. For each new tall tree sapling that establishes on the grid cell, a diameter at breast height between 1 and 2 cm is assigned randomly.

The model HYBRID is also based on the ecophysiological model Forest-BGC in combination with the gap model ZELIG (Friend *et al.* 1997). In HYBRID, competition between small trees and the grass layer is modelled, but the grass layer is treated as if it was one individual (Friend *et al.* 1997). In this model, the initial size of tall tree saplings is stochastic, as in Fire-BGC. The major problem of these hybrid models is the difficulty in parameterising these detailed processes for more than a few well-studied tree species.

1.2 Size class models

In this type of models, forest structure is described using discrete size classes. There are two major types of discrete size class models.

1. **Size class models with a discrete approach based on transition matrices:** A simplified procedure for each time step is that trees in a height class can grow into the next height class with a class-specific transition probability. The height of trees within a size class is not considered, i.e. a uniform distribution is assumed.
2. **Size class models with a discrete approach with transition probabilities between size classes but with continuous growth functions within each class:** The simplified procedure here is that trees in each size class grow according to a growth equation and if they reach a size in the region of the upper border of their size class they change the height class with a class-specific transition probability. Thus, in contrast to matrix models, the height of trees within a size class is simulated.

Below, these two approaches are explained in more detail.

1.2.1 Discrete approach based on transition matrices

Matrix models are widely used in ecology (e.g. Enright and Ogden 1979, Usher 1981, Caswell 2001). In the context of forest succession, these models simulate the dynamics in an entire stand by dividing it into a fixed number of stages (e.g., age, height or dbh classes), and they consider the fraction of individuals in each class that change the discrete class within a time step. Matrix models therefore basically consist of a matrix of fractions or probabilities that indicate the rate of change of the distribution of

the individual trees over the size classes. For this reason, Porté and Bartelink (2002) used the term ‘discrete distribution models’ to characterize this type of models. If large numbers of trees are observed, the probability distribution may be replaced by the number of trees in a class i at time t ($N_{i(t)}$), and transition probabilities can then be interpreted as proportions of trees changing from one class to the other. During a time step, a tree in a class can therefore remain in the same class i (g_{ii}), grow into another class j (g_{ij}), die or get harvested. Mortality and harvest are not implemented directly, but if the column total in the matrix is less than one, the missing fraction has died or got harvested. All such size class models are empirical models because the ecological processes that determine these changes are not modelled explicitly, but only their aggregated result is considered. Furthermore, because the transition probabilities (g_{11} , g_{22} , g_{33} , g_{nn}) are constant in time, the models are deterministic, which is a notable contrast to the ‘gap’ models reviewed above.

According to the assumptions made in such matrix-based models, they can be divided into (see also Fig. 1):

- First order Markov chains
- Leslie (or Usher) matrices
- Second order Markov chains
- Generalized matrices

First order Markov chains

First order Markov chains are based on two major assumptions: (i) the number of states is finite, and (ii) the changes from one state to any other state depend only on the current state and not on historic events in the system (e.g. Boyer 1979). Thus, the state at time $t+1$ can be calculated from the state at time t and the matrix with the transition probabilities. Mathematically, a Markov chain can be expressed according to equation 3:

$$N_{(t+1)} = \mathbf{A} * N_{(t)} \quad (3)$$

where the vectors $N_{(t)}$ and $N_{(t+1)}$ contain the frequencies in each class at time t and $t+1$

$$N_{(t)} = \begin{pmatrix} n_1 \\ n_2 \\ \dots \\ n_n \end{pmatrix} \text{ and the transition probability matrix } \mathbf{A} = \begin{bmatrix} g_{11} & g_{12} & \dots & g_{1n} \\ g_{21} & g_{22} & \dots & g_{2n} \\ \dots & \dots & \dots & \dots \\ g_{n1} & g_{n2} & \dots & g_{nn} \end{bmatrix}$$

Such first order Markov chains were mostly used to simulate changes between landscape types (Cherrill *et al.* 1995), vegetation types (Van Hulst 1979, Scanlan and Archer 1991, Aavisksoo 1993, Starfield and Chapin 1996), forest structure types (Bebi

et al. 2001) or between species which represented a patch or zone (Waggoner and Stephens 1970, Horn 1975, Enright and Ogden 1979, Huhta *et al.* 2001, Yemshanov and Perera 2002).

Leslie matrices or Usher matrices

In this approach, the time interval and class width are chosen so that no tree can grow more than the equivalent of one class width during a period (= Usher assumption). Examples are age classes with a width of one year, and a time step of the model of one year. This causes a substantial reduction in the number of parameters in the matrix that have to be estimated. Mathematically, such a matrix model can be expressed according to equation 4 (that is equal to Eq. 3, but with a different matrix **A**):

$$N_{(t+1)} = \mathbf{A} * N_{(t)} \quad (4)$$

$$\text{with } \mathbf{A} = \begin{bmatrix} g_{11} & 0 & 0 & \dots & 0 \\ g_{21} & g_{22} & 0 & \dots & 0 \\ 0 & g_{32} & g_{33} & \dots & 0 \\ \dots & \dots & \dots & \dots & \dots \\ 0 & 0 & 0 & \dots & g_{nn} \end{bmatrix}$$

An Usher matrix-based model can therefore easily be generated from successive tables of stem numbers per class, i.e. from stand tables (Enright and Ogden 1979, Enright and Watson 1991, Osho 1991, West 1995, Hoffmann 1999). By doing so, however, the projections into the future are limited to multiples of the interval associated with the data of these stand tables (e.g. Enright and Ogden 1979). Harrison and Michie (1985) presented methods to calculate a matrix of an interval of one year from a transition with a time interval of 13, but the resulting model was sensitive to the width of diameter classes, as trees grew more than one size class during a year. They recommend keeping the width of the diameter classes small relative to the expected diameter growth rate of the modelled trees. That means to divide each class into two, three, or more subclasses and then apply their method to the larger matrix, so as to avoid an overestimation of growth rates (Harrison and Michie 1985).

Furthermore, in contrast to strict first order Markov chains, tree ingrowth is incorporated in Leslie matrices or Usher matrices by the values in the top line of the matrix. These values determine the fractional number of offspring per adult that is produced by trees of a certain diameter class during any time step (equation 5, again equal to Eq. 3 but matrix **A** differs).

$$N_{(t+1)} = \mathbf{A} * N_{(t)} \quad (5)$$

$$\text{with } \mathbf{A} = \begin{bmatrix} g_{11} + f_1 & f_2 & \dots & f_n \\ g_{21} & g_{22} & \dots & 0 \\ \dots & \dots & \dots & \dots \\ 0 & 0 & \dots & g_{nn} \end{bmatrix}$$

This idea originally comes from zoological applications of the formalism, where it represented the fecundity of adult animals (f).

In tree models, however, these ‘fecundity’ values comprise seed production of trees of a certain diameter class, the probability of seed dispersion and germination rates of these seeds (e.g. Enright and Ogden 1979, Enright and Watson 1991, Kolström 1993, West 1995), and often also the establishment rate of the germinated tree seedlings and saplings up to a certain dbh (e.g. Ek and Monserud 1979, Pukkala and Kolström 1988, Osho 1991). This means that a tree reaches the age of sexual maturity with a certain dbh and then produces a constant amount of seeds each time step. Consequently, the more trees of a dbh class are present, the more offspring is generated.

Silvertown and Dodd (1999) used several of these matrices one after the other to simulate wave-regeneration dynamics in forest stands. Apart from tree growth, such Leslie matrix models were also used to simulate tree decay (e.g. Raphael and Morrison 1987, Morrison and Raphael 1993, Krays *et al.* 2002) or stages in the life of a tree (e.g. Leak 1986, Tolvanen *et al.* 2001).

Second order Markov chains

The matrix approach can be extended by relaxing the second Markov assumption that the changes from one time step to another depend only on the current state. For example, second order Markov chains allow the state of the forest at time t to depend on its states at time $t-1$ and $t-2$. Let the number of trees in the class i be the number of trees that have grown up ($N_{(i-1)i}$) plus the number of trees that remained in the class (N_{ii}), then equation 4 changes to equation 6:

$$N_{(t+1)} = \mathbf{A} * N_{(t)} \tag{6}$$

$$\text{with } N_{(t)} = \begin{pmatrix} n_{01} \\ n_{11} \\ n_{12} \\ n_{22} \\ n_{23} \\ n_{33} \\ \dots \\ n_{nn} \end{pmatrix} \text{ and } \mathbf{A} = \begin{bmatrix} 0 & 0 & 0 & 0 & 0 & 0 & \dots & 0 \\ g_{011} & g_{111} & 0 & 0 & 0 & 0 & \dots & 0 \\ g_{012} & g_{112} & 0 & 0 & 0 & 0 & \dots & 0 \\ 0 & 0 & g_{122} & g_{222} & 0 & 0 & \dots & 0 \\ 0 & 0 & g_{123} & g_{223} & 0 & 0 & \dots & 0 \\ 0 & 0 & 0 & 0 & g_{233} & g_{333} & \dots & 0 \\ \dots & \dots & \dots & \dots & \dots & \dots & \dots & \dots \\ 0 & 0 & 0 & 0 & 0 & 0 & \dots & g_{nnn} \end{bmatrix}$$

where g_{ijk} is the transition probability for a tree in state i at time $t-1$ and state j at time t to move to state k at time $t+1$. For example, it can be implemented that small trees that have grown well have a tendency to grow well again, and small trees that have not grown well tend to have a higher probability of dying (e.g. Picard *et al.* 2003). Obviously, such an approach can also include ‘fecundity’ parameters like the Leslie matrix approach. Note also that the approach can easily be extended to higher-order Markov chains.

Generalised Matrices

When a matrix approach is used for modelling tree diameter or height classes, most modellers allow trees to grow more than one class per time step (thus violating the Usher assumption). A tree in class one, for example, can grow into the second class (g_{21}), or directly into the third class (g_{31}), and so on (e.g. Pukkala and Kolström 1988, Caswell 2001), but trees cannot usually shrink, i.e. they can not become smaller (equation 7).

$$N_{(t+1)} = \mathbf{A} * N_{(t)} \quad (7)$$

$$\text{with } \mathbf{A} = \begin{bmatrix} g_{11} + f_1 & f_2 & \dots & f_n \\ g_{21} & g_{22} & \dots & 0 \\ g_{31} & g_{32} & \dots & \dots \\ \dots & \dots & \dots & g_{nn} \end{bmatrix}$$

If browsing by ungulates should be included, probabilities to shrink could be included in the matrices. This means that a tree could then also change with a certain probability to a smaller size class instead of only remaining in the same class or growing up (Bugmann 2000).

Another approach where the second Markov assumption is relaxed is when the probabilities in the matrix are time-dependent. Tree recruitment, growth or mortality can be modelled e.g. as being density-dependent. The number of trees in a certain diameter class at the next time step is then calculated, for example, by Buongiorno *et al.* (1995) using equation 8:

$$N_{(t+1)} = (\mathbf{A}_{(t)} + \mathbf{R}) * (N_{i(t)} - H_{(t)}) + C \quad (8)$$

where $N_{i(t)}$ is the number of trees in class i at the previous time step t , H is the vector describing harvesting, C is a vector of constant tree ingrowth into the smallest size class, and $G = \mathbf{A}_{(t)} + \mathbf{R}$ is the growth matrix, which contains the transition matrix (\mathbf{A}) and the recruitment matrix (\mathbf{R}). The matrix \mathbf{A} contains the probabilities that a tree from class i grows into another class j (g_{ij}) or remains in the same class (g_{ii}), similar to other matrix models. However, the transition probabilities (g_{ij} and g_{ii}) are derived from field data and depend on basal area and numbers of trees of different species. Hence,

Buongiorno *et al.* (1995) calculated different matrices for various levels of basal area. At each time step, the matrix for the current basal area was then taken to calculate the new growth increments (Buongiorno *et al.* 1995). The recruitment matrix **R** contains species effects on the ingrowth of other species (density-dependent recruitment). This general matrix approach was successfully used in several forest studies (e.g. Buongiorno and Michie 1980, Lu and Buongiorno 1993, Lin *et al.* 1996, Volin and Buongiorno 1996, Kolbe *et al.* 1999). Similarly, Takada and Nakashizuka (1996) implemented different matrices dependent on the number of trees larger than 32 cm dbh (Takada and Nakashizuka 1996).

1.2.2 Discrete approach with continuous growth functions within each class

In the so called canopy layer models, forest structure is described using discrete size classes and transition probabilities between classes, but in contrast to matrix models growth within each class is simulated using functions for the annual size increment (e.g. Huth and Ditzer 2000). This implies that not only the number of trees per class (N_i) or the biomass of these trees (B_i) has to be known in time, but also the average height of the trees within each class (H_i).

Growth

In the models FORMIX (Bossel and Krieger 1991) and FORMIX2 (Bossel and Krieger 1991, Bossel and Krieger 1994), individual trees are aggregated into five height classes, i.e. ‘seedlings’, ‘saplings’, ‘poles’, ‘main canopy’, and ‘emergents’ (= dominant canopy trees, ‘tree giants’). Each class is characterised by its biomass and height (Bossel and Krieger 1991, Bossel and Krieger 1994). Both FORMIX models are largely mechanistic. The explicit accounting of assimilation and dissimilation rates leads to the growth of biomass, diameter, and height in each layer. Leaf mass per layer determines photo-production of that layer, and light and thus photosynthesis conditions in lower layers. The transition of trees from one layer to another layer is estimated using probabilities. Huth *et al.* (1998) restricted in their model FORMIX3 the possibility of size class transition to situations in which the mean height of trees in a size class reached the maximum height of this class. When this was achieved, 10% of the trees in this class changed to the next class per year (Huth *et al.* 1998, Huth and Ditzer 2000).

The FORMIX models are distance-dependent models. Therefore, an entire forest stand is described as a mosaic of individual forest patches (i.e. ‘sub-forests’), with each patch having its own dynamics and interactions with the neighbouring patches (Bossel and Krieger 1991, Bossel and Krieger 1994).

The model FLAM (= forest layer model) was derived from the individual tree based gap model FORSKA (Prentice and Leemans 1990, Prentice *et al.* 1993) by using a height-class structured approach (Fulton 1991). In each forest patch, growth in each class (5 m height classes) is based on the growth of a representative tree of this particular height class, i.e. a tree with the mean characteristics of the height class. Its growth depends on light availability, total biomass, maximum biomass, vertical leaf area and maintenance cost of species (i.e. cost of the sapwood required to support a given leaf area at a given height, Fulton 1991), like in the gap model FORSKA. However, in contrast to the continuous height distribution in the gap model, FLAM requires transition probabilities to model the proportion of trees changing from one height class to the other. These transition probabilities are simulated as a binomially distributed random variable (1 or 0); the transition from one class to the other is therefore a purely stochastic process in FLAM.

In the aggregated gap model DiscForM (= distribution based, climatic driven forest model), it is assumed that tree size within each height class is uniformly distributed, like in matrix models. However, in DiscForM no explicit transition probability is calculated, but if for example, trees grow 1.4 times the width of the size class, 60% of the trees are allocated to the next higher class ($k+1$) and 40% of the trees to $k+2$ (Lischke *et al.* 1998). Furthermore, DiscForM describes forest structure using the assumption that in each time step all trees of a certain height are distributed randomly over the whole forest (and not in patches like in FLAM and FORMIX). This results in a frequency distribution (i.e. Poisson distribution) within each height class that is used to calculate light distribution. As light is the main factor limiting growth, trees in the model DiscForM are divided in height-light classes (Lischke *et al.* 1998, Löffler and Lischke 2001). In DiscForM, growth within each height – light class is simulated in a similar manner as in the gap model ForClim, from which it was derived, by modifying equation 1 and 2 to a height class approach (Lischke *et al.* 1998).

Mortality

In FORMIX, mortality is a stochastic process that depends on height increment (Bossel and Krieger 1991). Mortality in FLAM and DiscForM includes the two types described in the gap model section above, i.e. mortality is mainly a function of the relative growth efficiency of the trees (e.g. Fulton 1991).

Tree regeneration

In FORMIX, tree regeneration is mainly modelled with a ‘seedling’ class, which includes tree seedlings and small saplings of 0-1 cm in diameter and 0-1.3 m height (Bossel and Krieger 1991). Tree seedlings or small saplings enter this class at a rate which is a function of (i) seed availability from mature trees in the main canopy and in the ‘emergent’ layer, (ii) germination rate (seed survival = 25%/year) and (iii) planting.

The growth of these tree seedlings and small saplings is a function of the light reaching the ‘seedling’ layer (as described under growth).

Establishment in FLAM is modelled similarly as in the gap model FORSKA; if light availability below the bottom layer is above the compensation point for a species, a number of tall tree saplings is introduced with a height of 1.3 m (Fulton 1991).

In DiscForM, tree recruitment is implemented as in traditional gap models (see section gap models). In a revised version of DiscForM, immigration, i.e. the first appearance of a certain species in the seed pool of a species, is determined by a species-specific parameter (Keller *et al.* 2002). In the model TreeMig, the location of every single patch is modelled, and the ‘local’ dynamics are simulated using the DiscForM approach. In addition, seed dispersal between these patches and seed storage in the seed bank are integrated, so as to make it possible to investigate tree migration processes (Lischke *et al.* 2001).

1.3 Forest management simulators

Forest management simulators typically are constructed to simulate the growth increment for 10 – 20 years under different harvesting regimes (Hasenauer *et al.* 2000). In these models, individual trees are either simulated in a spatially explicit manner based on their exact locations (i.e. distance-dependent tree models, e.g. Ek and Monserud 1974, 1979, Pretzsch 1992, Liu and Ashton 1998, Pukkala *et al.* 1998, Chave 1999, Courbaud 2000, Pretzsch 2001), or the positions of the single trees in the stand are not included (i.e. distance-independent tree models, e.g. Sterba and Monserud 1997, Stage and Wykoff 1998, Sterba *et al.* 2001, Sterba *et al.* 2002).

Growth

Most forest management simulators calculate tree growth based on a growth potential which is site- and species-specific (note that in gap models this was a maximum growth potential). The growth potential of a tree is then reduced by competition and other limiting factors (Ek and Monserud 1974, 1979, Pretzsch 1992, Pretzsch 2001). In other forest management simulators, the growth functions are based on empirical data using regressions (Erni and Lemm 1995, Sterba and Monserud 1997, Liu and Ashton 1998, Pukkala *et al.* 1998, Stage and Wykoff 1998, Courbaud 2000, Sterba *et al.* 2001, Sterba *et al.* 2002), and some models use a mechanistic approach to modelling growth, by calculating the potential net carbon assimilation of each tree (Chave 1999). Competition for light is included in all models, usually via crown length and crown competition indices. Crown length is used to provide information about the competition a tree was exposed to in the past, and the crown index as a measure for the competition currently experienced by a tree (Hasenauer *et al.* 2000). In these models, either diameter increment (e.g. Chave 1999) or height increment (e.g. Courbaud *et al.*

1993, Pretzsch and Dursky 2002) are simulated, and the other variable is calculated using an allometric relationship between diameter and height.

Mortality

In some forest management simulators, it is mainly assumed that trees are harvested, and therefore no natural mortality is included (Courbaud *et al.* 1993).

In the model of Courbaud *et al.* (2001), mortality is included only through the disappearance of trees that do not receive enough light to survive (Courbaud *et al.* 2001).

Tree regeneration in distance-dependent forest management simulators

Tree ingrowth in spatially explicit models cannot be modelled simply by considering the number and dimensions of the tree saplings, since their location must also be taken into account. Most often, the location is selected at random among the open areas of a stand, or as a function of distance from parent trees. Spatial variability of tree regeneration in these models can therefore be due to seed production and dispersal processes, and also due to shading interactions of trees.

In the regeneration sub-module of the model TROLL (Chave 1999), seed dispersal is modelled including a seed bank. No tree seedling or small sapling is modelled, but tall saplings establish after a certain time lag, with a species-specific recruitment rate and a dbh of 1 cm.

Ek and Monserud (1974) simulated tree regeneration using a Markov chain approach with an age class width of 1 year, while Monserud and Ek (1977) used tree size classes in their regeneration module for the model FOREST for northern hardwood stands. This latter approach was used because tree size, rather than age, is the variable that determines when an understory tree reaches the overstory. Therefore, Monserud and Ek (1977) considered small plots, and within each plot they distinguished 5 height classes (0-15 cm, 15-61 cm, 61-137 cm, 1.37-3.05 m, 3.05-7.62 m). The growth rate of the midpoint tree in each height class was calculated in a manner similar to that of the large trees, using a potential height increment and a competition index (Monserud and Ek 1977). Tree ingrowth into the smallest size class was estimated by a series of sequential processes (e.g. seed production, dispersal, viability, and germination), culminating in the establishment of a tree seedling.

In their regeneration submodel for the model MOSES, Golser and Hasenauer (1996, 1997) predicted 5-year height increment for different height classes by adjusting the corresponding potential height increment using (i) the competition of the remaining overstory (as Monserud and Ek 1977), (ii) the intra- and interspecific competition among the saplings itself, and (iii) a modifier for the edge effect on the incidence of light (Golser and Hasenauer 1996, 1997). This tree regeneration model is therefore actually a size class model with a continuous distribution approach.

Tree regeneration in distance-independent forest management simulators

In the model PROGNOSIS (Stage and Wykoff 1998), Ferguson and Carlson (1993) predicted only the probability of stocking (using regression analysis based on field data), the number of trees if the plots were stocked, the number of species and height of the trees (at least 15 – 30 cm, resp. 3 years before reaching a dbh of 7.5 cm) every 10 or 20 years. Random values were taken from Weibull distributions to estimate the number of trees and species (Ferguson and Carlson 1993). Tree ingrowth was then added to the tree list. With this approach, only the number and height of tall tree saplings is projected, but no growth of an individual sapling is modelled.

Sterba (1997) proceeded in a similar manner as Ferguson and Carlson (1993) by estimating the probability of stocking, a random number for the height of the small tree saplings and a probability to take into account ungulate browsing (Sterba *et al.* 1997). However, the model predicted the actual periodic 5-year height increment according to Golser and Hasenauer (1996 and 1997), as reviewed above.

Tree regeneration in distance-independent forest management simulators is therefore not modelled on an individual basis either, even though the mature trees are then modelled individually.

2. Requirements for a model of tree regeneration in the Gandberg snag stands

The different model approaches presented in section 1 of this chapter have been constructed with different goals. To choose an appropriate model for a particular purpose, the following questions must be answered:

- What is the aim that shall be achieved with the model?
- Which data are available to build or parameterise the model?
- Which temporal resolution does the model need to have, so as to provide the desired information?
- Which spatial resolution does the model need to have?

What is the aim?

The purpose of the present thesis is to project succession in the Gandberg snag stands in the Swiss Alps into the future. More specifically, the aim is to simulate tree species composition, stem numbers and height of the tree saplings up to about the pole stage (ca. 5 m height) as accurately as possible, starting in 1993 when most of the *Picea abies* trees of the Gandberg forest died. The particular conditions of these snag stands should be taken into account, including (i) the model should be adequate for both the montane and the subalpine elevational levels of the Gandberg; (ii) the model should take into account immigration via seeds from neighbouring stands, the trees in the stands that survived the bark beetle attack, and advance tree regeneration; (iii) competition by large mature trees is unimportant and can thus be disregarded, (iv) competition by the herb layer may play an important role (cf. chapter III C) and thus must be taken into account, (v) browsing by ungulates is probably crucial for the height growth rate of the small tree saplings (cf. chapter III C). In addition, the decay of the snags should be included, particularly because coarse woody debris can be important as ‘nurse logs’ for tree regeneration in montane and particularly in subalpine forests of the Alps (Ott *et al.* 1997).

Which data are available?

From the Gandberg snag stands, a considerable amount of data about the decay process, ground-vegetation succession and tree regeneration are available from the permanent plots and the strip transects (cf. the results presented in chapter III). Additional data are available about succession in beetle-killed forests in other countries and in windthrow areas in the Swiss Alps. However, we have neither spatially explicit tree data for the Gandberg snag stands, nor on-site weather measurements, let alone long-term climatic measurements, snow depth, or soil data.

Which temporal resolution?

Directly after tree die-back it is sufficient to know the amount and height of tree regeneration every year, and later in succession even a time span of 5-10 years may still be adequate. The time period that needs to be simulated depends on the site-specific growth characteristics of the tree saplings: the slower trees grow, the longer it takes until a new forest stand can provide effective protection against rockfall and avalanches. Lüscher (1990) suggested that it may take at least 25-35 years for a tree to grow to this size in a montane or subalpine forest in the Swiss Alps, assuming maximum height increments (see also Introduction chapter I A). Therefore, I subsume that a time span of about 50 years should be sufficient for simulating tree regeneration in the montane and subalpine Gandberg.

Which spatial resolution?

The spatial resolution should be smaller than about 15 m in diameter, since openings of this size (or larger) are needed for snow-avalanche release in forests (see Introduction chapter I A). A simple model is used below to determine the minimum patch size: Tall tree saplings can be (1) distributed homogeneously over the whole patch (which is rare in nature, Fig. 3A), (2) aggregated in small groups (Fig. 3B), or (3) all the tall saplings can be concentrated in one corner of the patch (Fig. 3C). The latter, patchy distribution of tall saplings can strongly limit the protective effect of a stand, since gap size is increased (Fig. 3C, cf. Introduction chapter I A). I conclude that a model of tree regeneration for the Gandberg forest does not need to be spatially explicit with respect to the position of individual trees, but the spatial extent of the simulated patches should be no larger than roughly 10 m x 10 m.

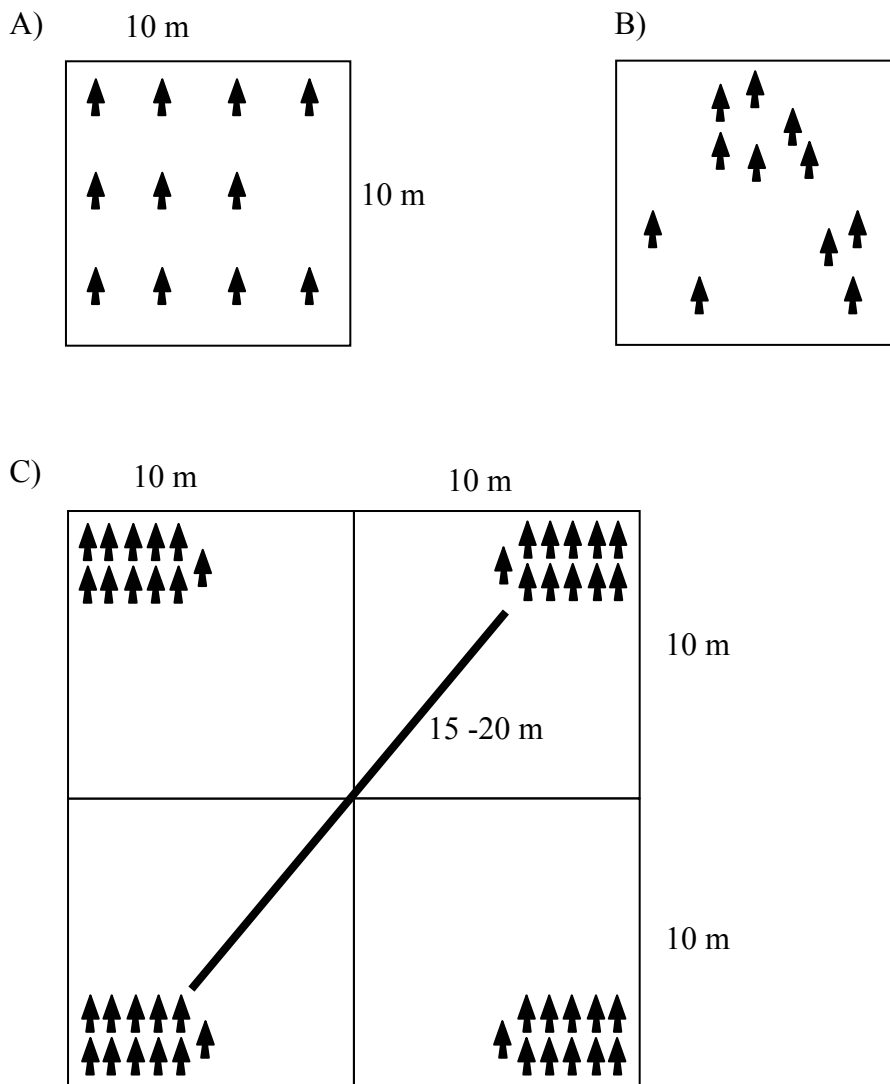

Fig. 3: A: Homogenous distribution of tall tree saplings across the entire patch; B and C: the same number of trees as in A, but aggregated in small groups (B) or in one large group per patch (C). In the ‘worst case’ of case C, where several patches of 10 m x 10 m each have one group of tall saplings at a maximum distance, this can lead to gaps with a diameter of about 15-20 m, which may be problematic for the protective effect of the forest against rockfall and avalanches.

3. Assessment of existing tree regeneration models with respect to modelling the Gandberg snag stands

3.1 General considerations

Empirical versus mechanistic approaches

Generally speaking, empirical models tend to be more precise for the specific stand they have been constructed for than mechanistic models. However, empirical models are normally restricted in their application to the conditions under which they have been fitted. For example, the generalised matrix model of Buongiorno *et al.* (1995), which had been constructed and utilised successfully for conditions of the French Jura mountains, had to be re-parameterised for the Italian Dolomites (Volin and Buongiorno 1996). However, the comparison of the semi-mechanistic models ForClim, PICUS, FORSKA and DiscForM, with field data from pristine forests in the Swiss Alps and in Scandinavia, suggested that *Picea abies* should be parameterised on the level of provenances (i.e. tree ecotypes) and not only on the level of species (Badeck *et al.* 2001). As the aim of the present thesis is to model the dynamics of particular snag stands in the Swiss Alps, it is to be expected that a model would have to be re-parameterised to these particular site conditions, regardless of the model approach.

It is possible that models which are based exclusively on general physiological and ecological mechanisms could be used to provide reliable results for other sites. However, few if any of the models reviewed above have been developed for or have been applied to snag stands. The conditions in a snag stand are quite different from those in a closed forest, or following other large-scale disturbances, and the ecological mechanisms operating in snag stands are not fully known yet. In addition, there are not enough data to improve the structure of a mechanistic model and to parameterise it for the specific site conditions of a snag stand. Hence, I conclude that a new, at least partly empirical approach has to be developed to simulate the snag stands on the Gandberg.

Individual-based versus cohort or whole stand approaches

Each forest tree interacts with others and has its specific characteristics. The individual tree-based approach therefore better reflects real forest dynamics than model approaches that operate at the level of the whole stand. However, an accurate parameterisation of such an individual tree-based model for the present study would be quite difficult, if not impossible. Especially the process of tree regeneration is generally difficult to model because seed dispersal, germination, and seedling establishment are highly stochastic processes. Hence these processes cannot be predicted accurately for each individual tree seedling or sapling. This is therefore a strong reason for

considering cohorts in patches or whole stands where variability is mostly averaged out. Consequently, cohort or whole stand approaches were used to incorporate the establishment of seedlings and small saplings (i.e. trees < 1.3 m) in almost all the models presented above, regardless of the organisational level that is used in the whole model.

Nevertheless, it is important to decide whether tree ingrowth is simulated with separate probabilities for all the regeneration processes (i.e., seed dispersal probability, germination rate and seedling establishment rate) or whether this is achieved using per species only one aggregated rate which contains all these processes (i.e., using one ingrowth rate). For all model approaches discussed above, there are examples of models that aggregate tree regeneration processes, and examples of models that separate these processes at least partly (for details see below).

Height versus dbh or age for modelling growth increment

The height of tree saplings can be modelled directly, or indirectly based on diameter increment or tree age. However, since tree height is more relevant than diameter for determining when a tree begins to provide effective protection against natural hazards, I prefer height growth as the primary target variable for the model in this study. Moreover, tree saplings can grow very slowly when suppressed, thus leading to old but still very small saplings. In the context of predicting the protective effect of a forest, the age or diameter of the tree saplings are of less interest than their number and height (cf. Introduction chapter I A). Hence, height growth should be modelled directly.

First conclusions

A model for the Gandberg snag stands must simulate:

- seed input, germination, mortality and height growth of tree saplings, including also browsing by ungulates
- must use empirically determined parameters or a semi-mechanistic approach and
- must consider small patches.

Below, additional details of the various models of tree regeneration are discussed. As far as available, some improvements regarding the general shortcomings of the approaches are presented and evaluated as well. In section 4, the final choice of a model approach is made.

3.2 Gap models

In traditional gap models, it is assumed that seeds of all species are always present in each patch. In mountain forests, where good seed years of coniferous species are scarce, this assumption is clearly violated. Even seeds of most pioneer trees can only be expected where fructifying trees are or were present in neighbouring stands.

Furthermore, growth of tree seedlings or small saplings (trees < 1.3 m) is not modelled because they have no diameter at breast height. In the growth equation of gap models (equation 2), they would even have a negative dbh (Fig. 2), and this clearly makes no sense. Therefore, new tall tree saplings establish without any time lag directly with a dbh of 0.5-1.5 cm and a corresponding height of about 2-3 m in most gap models. A model approach that does not consider height increment of small tree saplings, or at least a lag time for tree ingrowth, is too imprecise for my purpose, because it often takes several decades until a new tree reaches this height (e.g. Frehner 1989, Brang 1996, Schönenberger and Wasem 1999).

Furthermore, traditional gap models assume homogeneity in site conditions and disregard effects that are due to vegetation other than trees (according to Price *et al.* 2001). In reality, spatial heterogeneity often enables the survival of two or more species at different microsites within a stand, or at different sites in the landscape (e.g. Schönenberger 1975, Frehner 1989). In addition, most gap models do not consider the impacts of herbivory, i.e. no browsing of small saplings and no seed predation is included. Thus, traditional gap models are not appropriate for simulating tree regeneration in the Gandberg forest.

Several of the shortcomings mentioned above have been addressed in some recent gap models. For example, seed dispersal has been included in the models FORCAT (Waldrop *et al.* 1986) and ZELIG (Urban *et al.* 1991). The gaps are simulated with regard to their location in space, and seed availability depends on the presence of adult trees in neighbouring patches. In the PICUS model, Lexer and Hönninger (2001) consider seed production as a function of parent tree size and absorbed light. By doing so, spatial linkages between seed sources (mature trees) and germination sites are incorporated. Furthermore, zoochorous dispersal is included in the model PICUS (Lexer and Hönninger 2001), and dispersal by birds is taken into account in ZELIG (Urban *et al.* 1991). Nevertheless, in both models successfully established tree saplings enter the stand at an initial size of 1 cm dbh. Therefore, the fundamental problem regarding the slow growth of small trees in mountain forests is not addressed in any of these models.

Other gap models include growth of small tree saplings. The model FORECE (Kienast *et al.* 1999) includes growth of small saplings, a site-specific browsing intensity, a species-specific sensitivity of growth reduction by browsing, and death due to browsing stress (Kienast *et al.* 1999). However, the exact approach of implementing

the growth of trees smaller than about 1 cm dbh is not explained in detail (see problem with growth equation 2 explained above). Also in the model SORTIE, individual trees as small as 10 cm high are included in the simulations of growth and mortality like mature trees (Pacala *et al.* 1996). The number of small tree saplings is calculated by summing up the number of 5-year old saplings produced by every tree as a function of adult diameter, and multiplied by a probability density dispersal function. Therefore, tree ingrowth has to be estimated using a function that integrates all the processes from seed dispersal to the number of established 5-year old saplings per mature tree. In a field study in northern hardwood stands of Connecticut (North America), Pacala *et al.* (1996) found that the number of 5-year old small tree saplings varied considerably because of inter-site and inter-annual variability in fecundity (e.g. mast/crop years) and/or pre-establishment mortality. In the current version of the model SORTIE, this number is therefore not estimated, but a value was chosen arbitrarily that produced juvenile tree abundances similar to those in natural stands (Pacala *et al.* 1996). Unfortunately, the estimation of this number would be quite difficult in *Picea abies* mountain forests in Switzerland. In addition, neither competition effects by the ground vegetation nor browsing by ungulates are included in the SORTIE model.

Another approach to modelling of tree regeneration was adopted by Kellomäki and Väisänen (1991). In the model SIMA, they included 3 types of ground vegetation; pioneer, intermediate and climax species groups. Small *Picea abies* saplings were part of the climax species group. The potential growth was limited by the availability of light and nitrogen (Kellomäki and Väisänen 1991). However, the parameter values were assumed to be the same as for mature trees, i.e. the ground-vegetation group ‘pioneer species’ was assumed to respond like birch, ‘intermediate species’ like pine, and ‘climax species’ like spruce (Kellomäki and Väisänen 1991). Therefore, the same problem may occur as with extrapolating yield table data to trees smaller than 1.3 m.

In another model, called ForGra (= forest grazing model, Jorritsma *et al.* 1999), most of the relevant processes of tree regeneration establishment are modelled. Seed availability is calculated according to eq. 9:

$$\text{seed availability} = \text{seed production} + \text{seed immigration} - \text{seed dispersion} - \text{seed predation} \quad (9)$$

In ForGra, seed viability is assumed to be 70% for all species. Germination depends on total cover of ground vegetation and light availability at the forest floor. Growth of small saplings depends on a species-specific growth rate, which is reduced when light availability decreases below optimum values. Mortality of small saplings is caused by competition for light and space, and is related to total sapling biomass in a patch (Jorritsma *et al.* 1999). In the presence of herbivores, entire small saplings are consumed. New small saplings are initially described as cohorts of at least 1 m height. When height and age of a cohort exceed the minimum height in the gap model, these ‘saplings’ become individual trees. In addition, ForGra includes a simple routine for calculating changes in biomass of herb species and dwarf shrubs, based on initial

biomass and understorey productivity. However, only one ground-vegetation species per plot of 400 m² is modelled, by increasing biomass with a logistic growth curve of this species (Jorritsma *et al.* 1999). Particularly in subalpine forests, ground-vegetation is patchy (e.g., *Calamagrostis* carpets), but patch size is much smaller than 400 m². If tree regeneration in all frequent ground-vegetation types should be modelled using ForGra, a very large area would have to be simulated. Furthermore, ForGra was parameterised for forests in the Netherlands, and a complete reparameterisation would need to be done for using this model in the Swiss Alps.

In a recently developed submodel of ForClim, called HUNGER (= Herbivory by ungulates and its effects on forest regeneration), growth, mortality and browsing damage of cohorts of small tree saplings are modelled (Weisberg, unpublished data). New cohorts are initiated following a successful establishment event, i.e. germination and growth until a height of 10 cm. Mortality within each cohort is a function of stress associated with slow growth, a baseline rate associated with chance events (i.e. randomness), and a direct effect of browsing that is based on the proportion of leaf and branch biomass consumed by herbivores. In addition, net primary production, carbon and nitrogen allocation are modelled for each tissue type within height layers of 20 cm. This semi-mechanistic model has been parameterised only for *Picea abies* and *Fagus sylvatica* in Switzerland, but the development of this model has not been completed yet (Weisberg, unpublished data).

All gap models are semi-mechanistic (agree with my second criteria) and most of them consider forest succession in more or less small patches (e.g. 10 m x 10 m in JaBoWa (Botkin *et al.* 1972), or PICUS (Lexer and Hönninger 2001)). However, in ForGra, patch size is 400 m² (Jorritsma *et al.* 1999), and in many other gap models, it is even larger (often 1/12 ha = 833 m² = 28.9 m * 28.9 m; (e.g. Bugmann 1994). As tree position within a patch is unknown, such patch sizes are too large for simulating protection forests. Patch size could probably be reduced in these gap models to 10 m x 10 m, but this may cause a partial re-parameterisation.

In conclusion, none of these gap models fulfil all the requirements to simulate seed input, germination and height growth of tree saplings in the snag stands on the Gandberg, and a different approach has to be chosen.

3.3 Size class models

3.3.1 Discrete approach based on transition matrices

Generally, matrix models have several shortcomings, which have also a strong impact on modelling tree regeneration:

- Defining the states (e.g. determining the number of vegetation types or the size classes) is difficult. This can be overcome partly by using multivariate clustering of field data (Usher 1981).
- The data required for estimating the transition parameters are quite time-consuming to collect. As is evident from section 1.2.1 of this chapter, when x states are recognised, x^2 transition probabilities have to be estimated in a first order Markov chain, and x^3 in a second order Markov chain (Usher 1981). Acevedo *et al.* (1996) overcame this problem by using a gap model to estimate the transition probabilities.
- The transition from state_{*i*} to state_{*j*} depends only on the current state_{*i*}, but not on historic events in the system. This can be partly surmounted by implementing a higher order Markov chain. However, parameterisation becomes almost impossible if an effect which lasts longer than 5 or 10 years should be considered (e.g. growth rate after browsing of terminal shoots). Furthermore, such models seem to be sensitive to the choice of the width of the size classes (Picard *et al.* 2003).
- Transition probabilities may not remain constant in time.
- Spatial effects are averaged out, as only mean values for initial frequencies $N_{(t)}$ and transition rates are implemented. However, spatially explicit processes could be included, if a given stand was split in several smaller (e.g., 10 m x 10 m) patches. Consequently, for each different patch succession, a different matrix would then have to be estimated.
- It is impossible to include the arrival of completely new states in the future (e.g. new species, new vegetation types, or trees of a larger size class) in a matrix model. It is only feasible to include states with an initial frequency of zero in the vector $N_{(t)}$ and already fixed transition probabilities in the matrix A , so that other states change into these states. But this implies that the transition probabilities into such new states are already known, otherwise they have to be roughly estimated; if this is not possible, such states cannot be included in the model at all. In the Gandberg, the height of *Picea abies* saplings amounts to an average of only 15 cm (chapter III C). Thus, it is extremely difficult to estimate transition probabilities into a state which is dominated by *Picea*, i.e. the microsite type 'Picea' (see for this in chapter IV B, estimation of the transitions probability from the microsite type 'Rubus' into 'Picea').

- Furthermore, small portions of trees can grow in x time steps through all x size classes (where x is an integer between 0 and $+\infty$, cf. Table 1) because the size (or age) distribution within each class is assumed to be uniform. This leads to an overestimation of tree growth especially when tree seedlings occur in waves due to mast years. If the simulation results from such a model are used to estimate how long it takes until small tree saplings can provide effective protection against snow avalanches and rockfall, this small proportion of trees that grow too fast is likely to become a problem. In many matrix models, this shortcoming is addressed by choosing a small width of the size classes, or even by simulating age classes instead of height classes. The problem can also be reduced by dividing the main classes into many sub-classes with the same characteristics, a so-called box-car-train approach (Fig. 4).

Table 1: Results of a fictitious height class model implemented with an Usher matrix-based approach. Thus, the basic assumption is a uniform distribution of the tree heights in the classes. With a class width of 25 cm and an annual height increment of 5 cm, the constant transition probabilities in the matrix A are: $g_{ij} = 0.2$ ($j = i+1$) and $g_{ii} = 0.8$. Assuming irregular mast years, the model starts with 100 individuals with an average height of 5 cm in class 1 and no individual in all other classes (clear violation of a uniform distribution). After 3 time steps, a small portion of trees has grown into size class 4. This extreme example should clarify that a divergence between the real and the uniform height distribution has unintended consequences.

Year	Class 1 0-25 cm	Class 2 25-50 cm	Class 3 50-75 cm	Class 4 75-100 cm	Effective height [cm]
0	100	0	0	0	5
1	80	20	0	0	10
2	64	32	4	0	15
3	51.2	38.4	9.6	0.8	20
4	40.96	40.96	15.36	2.72	25
5	32.77	40.96	20.48	5.79	30

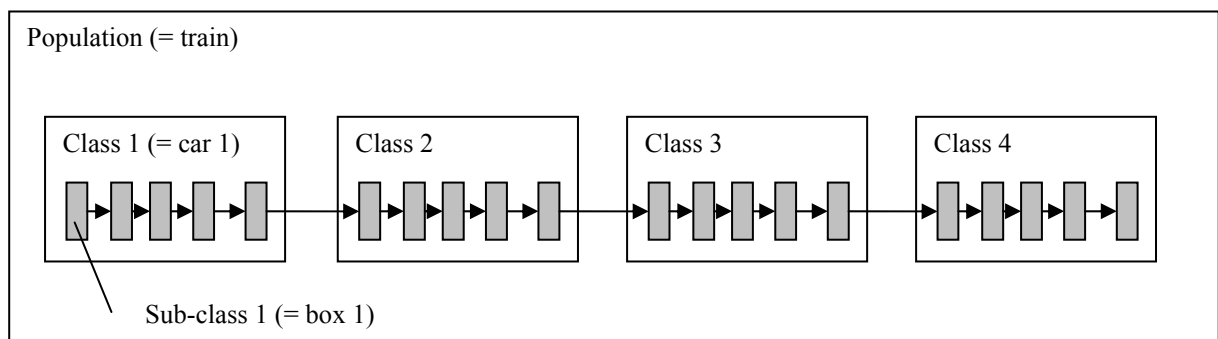

Fig. 4: Scheme of a size-class structured model with the box-car-train approach (modified from Lischke and Fischlin 2002).

The ‘fecundity’ probabilities (f) which are contained in the first line of Leslie or Usher matrices are constant values. Therefore, tree ingrowth is a linear function of the number of larger trees. Consequently, the more trees of such a dbh class are present, the more seeds or tree ingrowth are generated. However, *Picea abies* in mountain forests does not produce seeds in each year, but rather in a pseudo periodic manner (mast years). A constant amount of seeds per tree of a certain dbh class would therefore overestimate the amount of seeds in mountain forests in some years, and underestimate it in others. Probably, over long time periods and larger areas, this inaccuracy would be averaged out, but mast years are rare, particularly in subalpine forests. Therefore, it is important to take into account the irregularity of seed inflow. Kolström (1993) found that her Usher matrix model was quite sensitive to various levels of these constant ‘fecundity’ parameters ($f_1 - f_n$), and hence to the amount of tree saplings. If the lowest size class of a model is the seed class, then seed production and seed dispersal are aggregated in these ‘fecundity’ parameters ($f_1 - f_n$). However, if the lowest size class of a model is a class of small tree saplings or even of tall saplings, all the processes from seed production to seedling and sapling establishment and growth are aggregated in these ‘fecundity’ parameters ($f_1 - f_n$). Inevitably, the values of these ‘parameters’ vary over time, and a mean value is therefore difficult to estimate. According to Vanclay (1994), this limitation can only be overcome by more explicit methods of modelling tree regeneration.

In conclusion, pure matrix model approaches are not adequate to simulate tree regeneration in the snag stands on the Gandberg, particularly because of this small proportion of trees which could grow in x time steps through x size classes and the constant fecundity parameters.

3.3.2 Discrete approach with continuous growth functions within each class

In the distance-dependent stand simulator FORMIX, tree ingrowth is a function of the following processes: seed production, seed dispersal and germination (Bossel and Krieger 1991). However, these processes are aggregated in a single recruitment parameter. Furthermore, in the model FORMIX3, Huth *et al.* (1998) restricted the possibility of size class transitions to situations in which the mean height of trees in a size class reached the maximum height of this class. When this was achieved, 10% of the trees in this class changed to the next class per year (cf. 1.2.2 of this chapter). This approach is much more realistic than a classic matrix model because no tree can grow in x time steps through x size classes (cf. Table 1). However, this transition approach

implemented in FORMIX3 underestimates growth, as theoretically all and not only 10% of the trees with the maximum height of a size class should change their height class.

Browsing by ungulates and competition effects by ground vegetation are generally neglected in the FORMIX model family. In addition, the ‘seedling’ class contains tree seedlings and small saplings of a height between 0 and 1.3 m (Bossel and Krieger 1991). However, small tree saplings of 10 cm and 1 m are clearly not exposed to the same amount of light because of shading due to the ground vegetation, and therefore not all of them have the same growth rate, which is the assumption underlying FORMIX. If, however, the ‘seedling’ class in the model FORMIX were split into several classes with different properties, parameterisation of such a semi-mechanistic approach would become quite difficult.

Furthermore, the model FORMIX was constructed for a tropical dipterocarp forest in Malaysia (Bossel and Krieger 1991) and FORMIX2 for five species groups in the same tropical forest (Bossel and Krieger 1994). Bossel and Krieger (1991) implemented the model in a manner that allows the number of the modelled layers as well as the absolute height of the classes to differ. Nevertheless, re-parameterisation of this model for a mountain forest in Switzerland would not be a simple task.

As mentioned above, the aggregated gap models FLAM and DiscForM have mostly the same tree regeneration model approach as the gap models FORSKA and ForClim, respectively. In contrast, in the model TreeMig, a size class of trees smaller than 1.3 m is included. However, growth and mortality in TreeMig are only extrapolated from the taller height classes (Lischke, personal communication). This model approach is therefore not an effective improvement for simulating establishment of small saplings.

3.4 Forest management simulators

At least historically, forest management simulators were constructed to model the fate of planted, dense tree stands. Therefore, ingrowth of small tree saplings is not modelled in most of these models (Pukkala *et al.* 1998, Courbaud *et al.* 2001, Pretzsch 2001).

In the model TROLL (Chave 1999), however, tree ingrowth is modelled with a recruitment rate, which aggregates several processes in a single value, including germination and survival until 1 cm dbh. To take into account the time that passes between seed dispersal and when the tree reaches 1 cm dbh, a lag time is integrated in TROLL. This certainly constitutes an improvement over the traditional gap model approach, but it is exactly this lag time that is difficult to estimate, partly because it is quite variable in mountain forests.

Another approach to implementing tree regeneration in forest management models is to divide tree saplings into height classes, and then to simulate the growth rate of the midpoint tree in each height class by a potential height increment and reducing it according to a competition index (Monserud and Ek 1977, Golser and Hasenauer 1996, 1997, Sterba *et al.* 1997). However, the potential height increment of saplings can not be derived easily from field data (probably with the exception of greenhouse experiments). Therefore, Golser and Hasenauer (1996, 1997) extrapolated the regional site index function of yield tables down to trees saplings smaller than 1.3 m. This leads to unrealistically low height increments as compared to observed growth rates (Golser and Hasenauer 1996, 1997). Consequently, the maximum site index, not the local site index had to be chosen for calculating the potential height increment of small tree saplings (Golser and Hasenauer 1996, 1997). As the use of stand tables to project the growth of mature trees at a certain site is already subject to a controversial discussion (e.g., Pretzsch 1992), extrapolations of these tables to trees smaller than 1.3 m and the use of the resulting data for mountainous snag stands seems questionable.

In addition, neither competition effects by the ground vegetation nor browsing by ungulates are included in forest management simulators. For all these reasons, no forest management simulator seems appropriate to simulate tree regeneration in the snag stands on the Gandberg.

4. Selection of a model approach

As mentioned in section 3 of this chapter, none of the existing approaches to model tree regeneration seems fully appropriate for the snag stands in the Gandberg forest. Therefore, a new model has to be developed for these specific conditions.

I have already pointed out that simulating tree growth of seedlings and saplings up to mature trees with only one equation may pose problems (e.g. the gap model growth equation, or extrapolations of yield tables). Therefore, the approach of simulating growth in different size classes is probably best. The matrix approach is the simplest size class approach, but as shown above, there are several shortcomings in particular with the constant fecundity rate and the small portion of trees which can grow in x years through x size classes (cf. Table 1 in section 3.3.1 of this chapter). Hence, an approach that models height increment within each size class is preferred, even if in this case the average height and not only the number per height class have to be simulated.

Nevertheless, with a size class model with discrete size classes and with continuous growth functions within each class (such as FORMIX and FLAM), the problem of finding adequate transition rates from one size class to another has to be solved. Starting from a mast year, a large number of tree saplings would change from one size class to the next higher class at almost the same time. Therefore, neither a constant transition probability (matrix approach) nor a stochastic probability (e.g. like in

the model FLAM) would be adequate. As mentioned, in the model FORMIX3 there is only a transition of 10% in the case that the mean height of trees in a size class has reached the maximum height of this class (Huth *et al.* 1998, Huth and Ditzer 2000). Considering the mentioned mast years, tree saplings almost synchronously grow in their class to the maximum height in this class and then they should theoretically all change their height class, and not only 10% of them.

A similar transition problem, but for a totally different situation (i.e. hatching probability of zooplankton, Bugmann *et al.* 1989) was solved by calculating the transition probability as being the ratio of the difference between the average size in the class and the lower boundary of the class (= numerator) and the class width (= denominator). In the case of a height class formulation, this would result in equation 10:

$$\text{transition probability } p = \left(\frac{h_{\text{mean}} - h_{\text{min}}}{h_{\text{max}} - h_{\text{min}}} \right)^x \quad (10)$$

where h_{mean} = average height of the trees in a given class, h_{min} = minimum height of the class, and h_{max} = maximum height of the class. The parameter x is used to determine the shape of the curve (Fig. 5). Some trees grow faster than the average trees and would therefore change size classes earlier than average trees. This small amount of trees is probably simulated adequately by choosing a large x in this probability equation (cf. Fig. 5), e.g. $x = 20$.

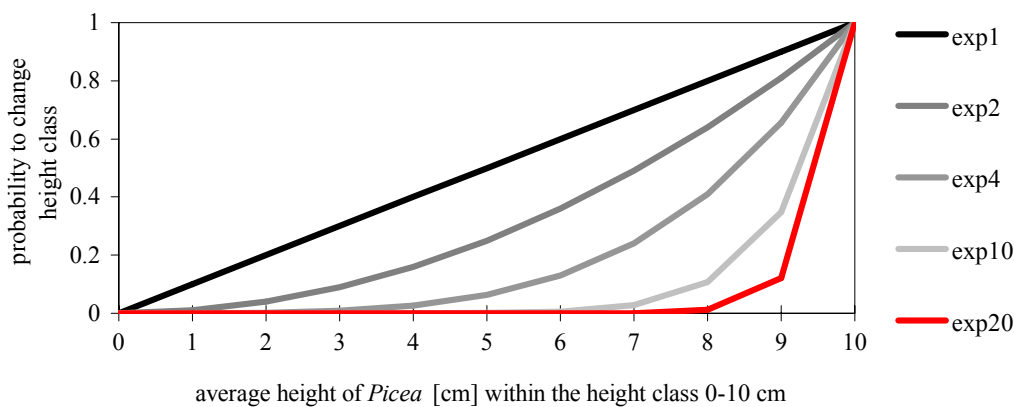

Fig. 5: Transition probability (i.e., probability to change to the next higher height class) according to equation 10 using different exponents x , shown here for a fictitious height class with a width of 0 – 10 cm.

Using this approach, tree mortality and browsing by ungulates can also be modelled separately for each size class. Furthermore, seeds can be incorporated as a ‘size’ class of their own, so that germination rate can be separated from tree establishment rates (as in some matrix models described above). In addition, mast years and seed dispersal can be modelled independently. Therefore, as required, all the

important processes of tree regeneration can be modelled separately from each other, thus significantly increasing the transparency of the overall model.

Finally, the problem remains that the ground vegetation probably has a high influence on the establishment of seedlings and small saplings in the Gandberg snag stands (chapter III C). Germination rates as well as the growth and mortality rates up to a tree height of about 1.3 m (ca. average height of *Rubus idaeus*, cf. chapter III C) all are probably related to the presence of ground vegetation. Therefore, not only trees, but also ground vegetation needs to be included in the model.

At least in the first years after the death of the *Picea abies* trees on the Gandberg, the ground vegetation changed rapidly (chapter III B). A first order Markov chain approach with vegetation-cover types was found to be the simplest approach but sufficient to simulate the ground-vegetation succession per se (see section 1.2.1 of this chapter).

Therefore, the question ensues how to couple a Markov chain vegetation model with a height-class structured model of tree regeneration. In the case of migratory organisms, the model matrices may contain (besides fecundity and transition probabilities) also migration probabilities (mi). For example, let us consider two populations living in separate regions, each with 3 states, i.e. n_1 - n_3 and n_4 - n_6 . The matrix model is then given by equation 11:

$$N_{(t+1)} = \mathbf{A} * N_{(t)} \quad (11)$$

$$\text{where } N_{(t)} = \begin{pmatrix} n_1 \\ n_2 \\ n_3 \\ n_4 \\ n_5 \\ n_6 \end{pmatrix}, \mathbf{A} = \left[\begin{array}{ccc|ccc} 0 & f_2 & f_3 & 0 & 0 & 0 \\ g_{21} & 0 & 0 & mi_{24} & 0 & 0 \\ 0 & g_{32} & 0 & 0 & mi_{35} & 0 \\ \hline 0 & 0 & 0 & 0 & f_5 & f_6 \\ mi_{51} & 0 & 0 & g_{54} & 0 & 0 \\ 0 & mi_{62} & 0 & 0 & g_{65} & 0 \end{array} \right]$$

This can also be expressed as $\mathbf{A} = \left[\begin{array}{c|c} \mathbf{A}_1 & \mathbf{M}_{2 \rightarrow 1} \\ \hline \mathbf{M}_{1 \rightarrow 2} & \mathbf{A}_2 \end{array} \right]$,

where the sub-matrices \mathbf{A}_1 and \mathbf{A}_2 are Leslie matrices describing the dynamics of size classes within the two regions, whereas the sub-matrices $\mathbf{M}_{1 \rightarrow 2}$ and $\mathbf{M}_{2 \rightarrow 1}$ describe migration between the two regions (Caswell 2001).

Obviously, an individual small tree sapling cannot migrate like an animal, but if the microsite it inhabits (i.e., the vegetation-cover type) changes into another vegetation-cover type with a certain probability, it will objectively be on another vegetation-cover type afterwards (Fig. 6).

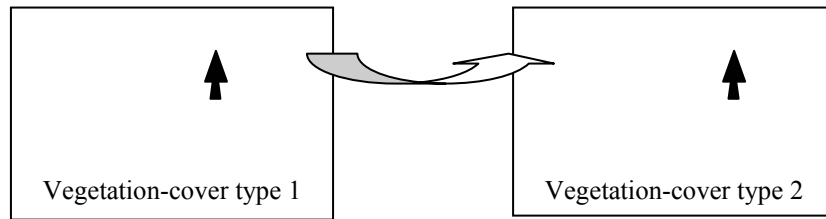

Fig. 6: ‘Migration’ of small tree saplings: tree sapling on a vegetation-cover type changes the vegetation-cover type (i.e. is subject to different growth and mortality rates) with the same probability as the vegetation-cover type changes into another type.

Mathematically, for small tree saplings this change in vegetation-cover type at one and the same site is equivalent to migration into another vegetation type. Therefore, the transition probabilities in a Markov chain model of vegetation can be used in a model of tree regeneration to calculate the ‘migration’ probability, i.e. the numbers of tree seedlings and small saplings that change from one vegetation-cover type into another as induced by a change of the ground vegetation (e.g., in Fig. 6 one tree has ‘changed’ its vegetation-cover type).

To the best of my knowledge, such a model coupling tree regeneration and vegetation-cover types has not been implemented yet. In particular, none of the available models combines (1) the transition probability (equation 10) for the changes between height classes and (2) transition probabilities between vegetation-cover types for changes in the vegetation surrounding the tree seedlings and small saplings. Therefore, I decided to develop a new, empirically-based, height-class structured model with continuous growth functions within each class for the tree regeneration in the snag stands of the Gandberg forest. The vegetation model is described in detail in chapter IV B, and the combined vegetation and tree regeneration model, i.e. the final new ‘RegSnag’ model, is presented in chapter IV C.

IV B Decay and vegetation succession model

Reprint of the submitted article:

Kupferschmid A. D. and H. Bugmann. (submitted): Predicting decay and vegetation development in *Picea abies* snag stands. *Plant Ecology*.



Photograph of a typical part at the upper subalpine level of the Gandberg in June 2001.

Predicting decay and vegetation development in *Picea abies* snag stands

Andrea D. Kupferschmid & Harald Bugmann

Abstract

In a *Picea abies* mountain forest on the Gandberg in the northern Swiss Alps, trees were killed by bark beetles in 1992-97. A combination of field studies and dynamic modelling was used to project snag decay and future vegetation succession in these steep, unharvested stands. In permanent plots, the ground-vegetation cover has been estimated and natural tree regeneration has been monitored annually since 1994. To obtain additional information on the abundance of snags, logs, boulders and other microsite types in the stands, the relative frequency of the microsite types was quantified along strip transects on four elevational levels. A dynamic model of snag decay and ground-vegetation development was constructed (modified matrix model approach). Based on field data and literature values, the model was initialised and parameterised separately for the montane and the subalpine level. For model validation, microsite types were quantified in 2001 with the line-intercept method on both elevational levels. Starting with the conditions in the stands before the bark beetle attacks, it was possible to project short-term succession and to simulate accurately the decay and ground-vegetation patterns eight years after tree die-back. Long-term simulations suggest that on the montane level, *Rubus idaeus* will be replaced by *Picea abies*, while on the subalpine level ferns will dominate for a long time.

Keywords

Calamagrostis villosa, coarse woody debris, matrix model, *Rubus idaeus*, tree decay, vegetation succession.

Nomenclature

Lauber and Wagner (1996) was used for ground vegetation and tree species; Oberdorfer (1993) for herbaceous plant associations; Ott *et al.* (1997) for forest associations.

1. Introduction

Insect infestations are a common disturbance factor in forest ecosystems (Holsten 1990, Parminter and Daigle 1997, Forster 2001). They can alter competitive relationships between plants not only directly through selective mortality, but also indirectly because defoliation triggers a carbon and nutrient release (Beudert 1999). Hence, insect infestations can alter the successional pathways in forests (Fleming 2000). The following short-term developmental patterns were reported after strong (>80%) beetle-caused tree mortality in various forest stands: (1) fast and extensive invasion of *Rubus idaeus* (Batzer and Popp 1985, Crawford *et al.* 1993, Osawa 1994, Hogget 2000, Kupferschmid 2002), (2) slight or extensive spread of *Calamagrostis sp.* (Yeager and Riordan 1953, Reif and Przybilla 1995, Schulz 1996, Holsten and Burnside 1997, Cole *et al.* 1999, Wurz and Wahrenbrock 2000, Heurich 2001, Jehl 2001), (3) invasion of *Rubus fruticosus aggr.* (blackberry) and other species that are characteristic of clear-cuts (Märkl and Eglseer 2001), and (4) quick development of pioneer tree stands dominated by *Alnus* and *Betula* (Baker and Kemperman 1974, Matsuoka *et al.* 2001).

In a *Picea abies* mountain forest on the Gandberg in the northern Swiss Pre-Alps, trees were killed by the European spruce bark beetle (*Ips typographus*) at the montane and subalpine elevational levels between 1992 and 1997 (Forster 1993, Wermelinger *et al.* 1999, Walcher and Kupferschmid 2001). Subsequently, the ground vegetation at the montane level changed into a *Rubus idaeus* association (Kupferschmid 2002), while mosses, ferns and grasses began to dominate at the subalpine level (Kupferschmid 2001). Thus, these two elevational levels on the Gandberg represent two of the most frequent successional pathways after beetle-caused conifer tree die-back.

Both *Rubus idaeus* and *Calamagrostis villosa* communities are known to provide few favourable microsites for tree establishment (e.g. Leibundgut 1984, Lieffers *et al.* 1993), and thus tend to slow down succession towards tree-dominated communities. In a steep mountain forest such as the Gandberg snag stand, it is important to know how long a *Rubus idaeus* or *Calamagrostis villosa* dominance will last, because neither *Rubus* brushwood nor *Calamagrostis* carpets provide effective protection against snow avalanches and rockfall, whereas *Picea abies* can provide protection (Brang *et al.* 2001). In this article, we present a quantitative model that can be used to project succession in these snag stands.

In many current forest succession models, ground vegetation is disregarded, and the focus is entirely on trees (e.g. Botkin *et al.* 1972, Horn 1975, Monserud and Sterba 1996, Golser and Hasenauer 1997, Hasenauer *et al.* 2000, Huth and Ditzer 2000, Bugmann 2001). However, tree regeneration is often competing heavily with ground vegetation (e.g. Yli-Vakkuri 1961), especially when *Rubus* or *Calamagrostis* are dominating (e.g. Sims and Mueller-Dombois 1968, Wurz and Wahrenbrock 2000,

Heurich 2001). Therefore, we propose that a model for our purpose needs to combine a consideration of the dynamics of ground vegetation and tree regeneration.

Kellomäki and Väisänen (1991) included in their tree succession model (SIMA) three types of ground vegetation: ‘pioneer’, ‘intermediate’ and ‘climax’ species groups. *Picea abies* regeneration was part of the climax group. Their distribution was dependent on light and nutrients, and the parameters for all climax species were assumed to be the same as for mature spruce trees. However, no shading or direct influences of the ground-vegetation species on *Picea* regeneration was considered. In our snag stand, tree regeneration may not be limited primarily by light (which depends on canopy structure) or nutrients, but it may rather depend on local soil structure and the growth form of ground-vegetation species. One possible simplification of all these complex processes is to merge all the abiotic and biotic influences on a specific small site (typically < 1 m²) by defining microsite types. Microsite types can be defined based on soil structure (e.g. deep soil, boulders) and the dominant species of the ground layer (e.g. mosses, ferns, etc.). Such microsite types can easily be recognised in field sampling. Tree regeneration can then be modelled separately on each microsite, with microsite-specific rates of germination, growth and mortality.

To take into account the changes in the ground vegetation or the transitions between the microsite types, respectively, we first derived a succession model for the ground vegetation. This succession model was mainly based on a matrix approach, distinguishing transition probabilities from each microsite type into all other microsite types. A matrix of the transition probabilities between all investigated types is a convenient summary of the possible changes. In those cases where the transitions do not depend on how the forest reached its present state but only on the present state itself, and when the transition probabilities are constant over time, the matrix approach was found to be both powerful and convenient (Waggoner and Stephens 1970, Van Hulst 1979). With such a first-order Markov chain approach, other authors have already successfully simulated changes between landscape types (Cherrill *et al.* 1995), vegetation zone types (Van Hulst 1979, Aavisksoo 1993, Starfield and Chapin 1996), forest structure types (Bebi *et al.* 2001) and between species (Waggoner and Stephens 1970, Horn 1975, Enright and Ogden 1979). In addition, such models were used to simulate changes between states of decay of ‘woody’ microsities such as snags, logs, etc. (Raphael and Morrison 1987, Morrison and Raphael 1993, Kruys *et al.* 2002). Nevertheless, to our knowledge they have never been used for modelling changes of microsite types. Therefore the objectives of the present paper were:

1. to divide the vegetation pattern recorded on the Gandberg into microsite types that are amenable to an analysis of successional processes.
2. to use this information to develop and test a dynamic model of the decay and ground-vegetation succession for a period of 8 years (1993-2001).

3. to predict the future successional pathways of the Gandberg forest on the montane (*Rubus* dominated) and subalpine (*Calamagrostis* dominated) level.

Below, we present the field sampling methods that were required for providing model parameters and to obtain an independent data set for model validation; we then describe the model structure, model initialisation and parameterisation as well as a first set of simulation results. In a second step, which is beyond the scope of the present paper, tree regeneration will be modelled explicitly, whereby the transition from ground-vegetation microsites into the microsite type '*Picea*' will occur when *Picea* trees overtop the ground vegetation (i.e. *Rubus*, *Calamagrostis* or ferns).

2. Study site

The study site is located on the north face of the Gandstock, south of Schwanden (canton of Glarus, Switzerland) at an elevation of 1100-1600 m a.s.l. The Gandberg inclines towards the North at an angle of about 14-36° (30-80%), and the site does not receive direct sunshine between October and April as a result of orographic shading. The soil is an acid brown soil with a tendency to podsol (Roth 1996). Its depth varies greatly due to the presence of red conglomeratic Verrucano (cf. Oberholzer and Heim 1910) boulders deposited by rockfall, mainly at the montane level. The estimated mean annual precipitation for the Gandberg forest is 1600-2000 mm and the mean annual temperature 2-3°C (Kupferschmid Albisetti in prep.).

Before the *Picea* die-back, which started in 1992, the entire Gandberg forest was dominated by Norway spruce (*Picea abies*). Only a few silver fir (*Abies alba*, 1%) and sycamore maple (*Acer pseudoplatanus*, 3%) trees were present. The stands belong to the *Galio-Abieti-Piceetum* association (cf. Ott *et al.* 1997) at the montane level and to the *Homogyno-Piceetum vaccinietosum myrtilli* association (cf. Ott *et al.* 1997) at the subalpine level. The stands at the montane level developed after a clear-cut in 1842-1846, and were later subject to some high-thinning (Forstverwaltung Kt. Glarus 1949). The stands at the subalpine level have always been more open and probably subject to little thinning only (Forstverwaltung Kt. Glarus 1949). In 1990, the forest had a growing stock of about 820 m³ ha⁻¹ at the montane level and 590 m³ ha⁻¹ at the subalpine level (Kupferschmid Albisetti *et al.* 2003).

Between 1992 and 1997, a large outbreak of *Ips typographus*, triggered by the windstorm event 'Vivian' 1990, caused the death of almost all *Picea abies* trees in an area of approximately 100 ha, with a peak mortality in 1993, when about 20 ha of *Picea abies*-dominated stands died on the Gandberg alone (Walcher and Kupferschmid 2001). Only about 2% of the *Picea* trees, but all *Abies alba* and *Acer pseudoplatanus* trees survived, scattered throughout the snag stands.

3. Methods for field sampling

3.1 Field data for model initialisation and parameterisation

3.1.1 Permanent plots

Since 1994, vegetation succession and tree regeneration have been investigated in a pilot study on 24 permanent plots of 1 m x 1 m at the lower montane level of the Gandberg where *Picea abies* trees had died in 1993 (Kupferschmid 2002, Kupferschmid *et al.* 2002). The cover of plants and mosses with a frequency higher than 5% was estimated annually (cf. Fig. 5 and Kupferschmid 2002).

In 2001, the frequency of 25 different microsite types was estimated additionally in these permanent plots (Fig. 1). These microsite types had been defined for the entire Gandberg forest (cf. chapter VII A in Kupferschmid Albisetti, in prep.) according to (i) the dominant plant and moss species and the associated soil surface characteristics (i.e. boulders, raw humus, mull) or (ii) the decomposition stage of woody debris (see ‘strip transects’, below).

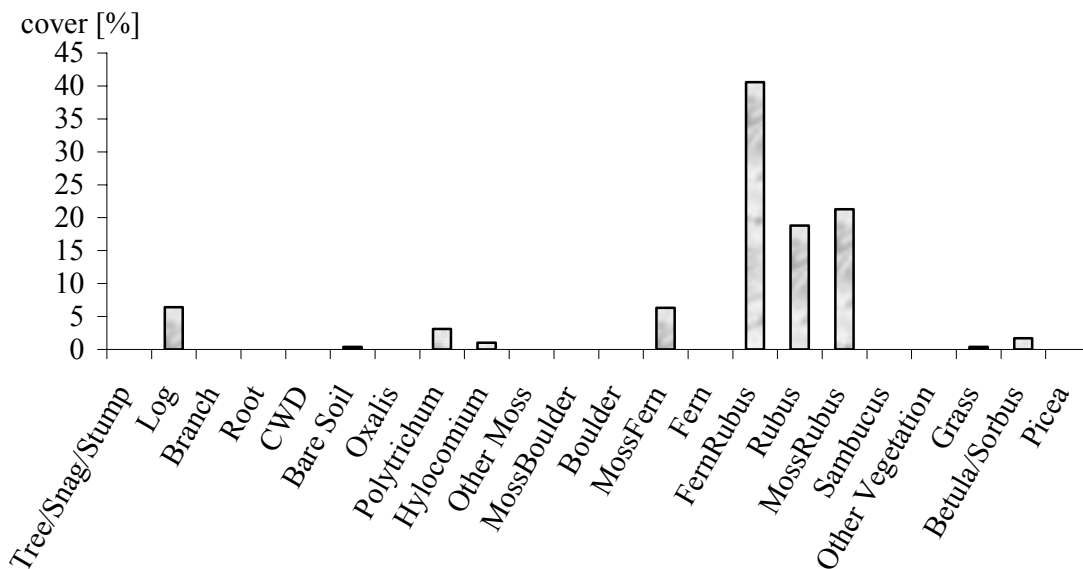

Fig. 1: Frequency of the 25 microsite types in the permanent plots of the lower montane level of the Gandberg in 2001. Some microsite types have frequencies of zero due to the location of the plots, i.e. they were not represented in the permanent plots (e.g. snags, stumps or boulders). CWD stands for the microsite type ‘Coarse Woody Debris’, Other Vegetation for microsite types which were dominated by other plants such as *Senecio ovatus*, *Galium odoratum*, *Galeopsis tetrahit*, *Epilobium montanum* or *Vaccinium myrtillus*.

3.1.2 Strip transects

To complement the permanent plot data, which covered only 24 m², the frequency of microsite types was also quantified by a spatially more extensive sample along four strip transects that were placed parallel to the contour lines (simply called ‘transects’ below) in summer 2000. Two transects with a length of 100-160 m and a width of 5 m were placed in two former *Galio Abieti - Piceetum* associations (lower montane level at 1280 m and upper montane level at 1360 m a.s.l.) and in two *Homogyno-Piceetum vacciniotosum myrtilli* associations (lower subalpine level at 1520 m and upper subalpine level at 1570 m). Along these transects, plots of 5 m x 5 m were delineated and the percent cover of 13 common microsite types was estimated per plot (cf. Fig. 2). On the basis of this first classification of microsite types, a more detailed classification (i.e. 25 types) was derived and used in 2001 in the permanent plots (see above). In addition, the diameter and length of all logs and snags in the transects were measured to estimate the timber volume of the snag stands (cf. Kupferschmid Albisetti *et al.* 2003).

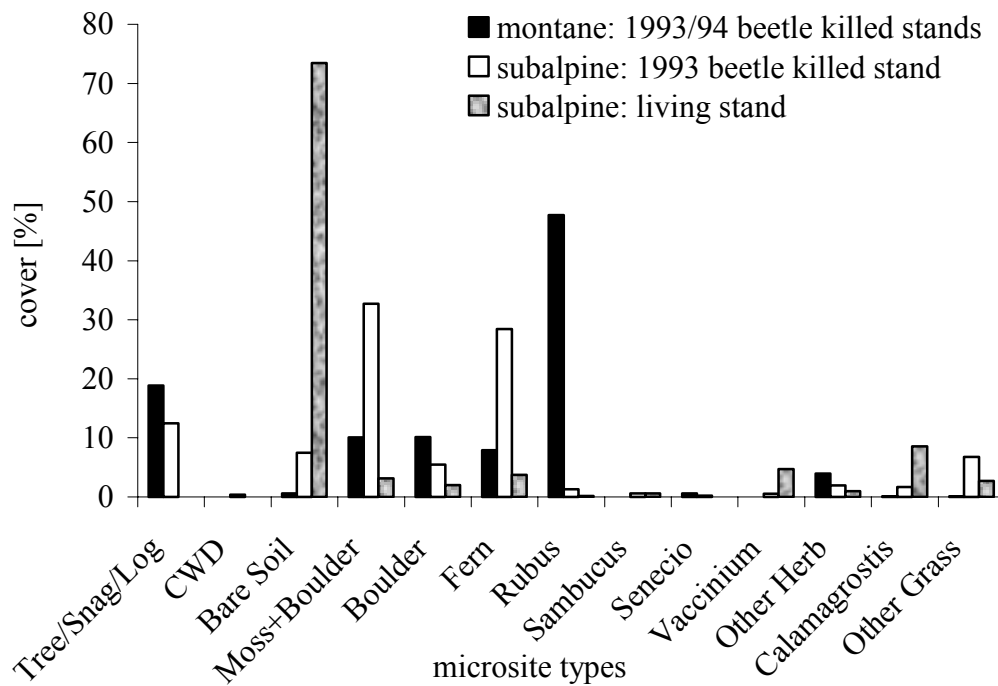

Fig. 2: Frequency of the 13 most common microsite types in the strip transects in 2000. Black bars: mean cover in stands at the lower montane elevational level, where trees died in 1993, and in stands at the upper montane level, where trees died in 1994. White bars: mean cover of stands at the upper subalpine level, where trees died in 1993. Grey bars: mean cover in still living stands at the upper subalpine level.

3.2 Sampling for model validation

In spring 2001, the percent cover of the same 25 microsite types as in the permanent plots was estimated in Norway spruce stands in which *Picea* trees had died in 1993 using the line-intercept method (for a description of the method see e.g. Canfield 1941, Parker and Savage 1944). Sampling took place at 4 elevational levels (lower montane: 1220-1280 m a.s.l., upper montane: 1310-1370 m, lower subalpine: 1460-1520 m and upper subalpine: 1540-1600 m). At each of the four elevational levels, eight groups of lines were selected randomly. Each group contained four lines 10 m long which were parallel ('E-W'), perpendicular ('N-S') and at an angle of 45° to the contour lines ('N-W', 'N-E'). Along these 128 lines (4 elevational levels x 8 groups x 4 lines per group), the length of the microsite types was measured with a measuring tape. From the lengths measured, the frequency of each microsite type was calculated. The set of 4 lines at each location was chosen so as to minimise errors due to vertically and horizontally different dimensions of the various microsite types. Note that this data set was not used for model parameterisation.

The frequency of all microsite types found on the lower montane level was very similar to that on the upper montane level (e.g., 22 separate Wilcoxon tests for unpaired samples of $N_1 = N_2 = 8$ (each value was a mean of the 4 lines), $p \gg 0.05$, only 'MossFern' was less frequent on the lower-montane level, $p < 0.05$). In contrast, the frequency of the microsite types 'FernRubus', 'Rubus', 'MossRubus', 'Grass', 'MossBoulder' and 'Hylocomium' differed significantly between the lower subalpine and the upper subalpine level (22 separate Wilcoxon rank sum tests for unpaired samples of $N_1 = N_2 = 8$, $p < 0.05$ for the types listed). In fact, the validation data of the lower subalpine level represent the vegetation of a transition zone between montane and subalpine vegetation. On the subalpine level, the frequencies of the microsite types 'Grass', 'Rubus' and 'FernRubus' were significantly different from both those on the upper subalpine level and those on the lower and upper montane levels (Wilcoxon rank sum tests, $p \ll 0.05$). Therefore, we will evaluate the model simulations against a validation data set that comprises the entire montane level, but separately against the data from the lower subalpine and the upper subalpine level (see Results section, Fig. 6, 7 A and B).

4. Model description

4.1 General model description

A modified matrix model approach (for a description of classic matrix models see e.g. Vanclay 1994, Caswell 2001) was developed to study the temporal development of the frequency of microsite types at the montane and subalpine levels of the Gandberg. The model does not track the location of the microsities (i.e., it is spatially non-explicit), and it operates on annual time steps. A schematic diagram of the model is given in Fig. 3.

The model consists of two sub-models; one for the microsite types with woody material ('Logs', 'Branches', etc.), and one for all non-woody microsite types, including 'Boulders', 'Bare soil' and all types with plant cover. This splitting was necessary because of the peculiarities of the 'woody' microsite types, particularly with respect to dead trees, as follows.

Woody microsite types: During the tree decay process, the area occupied by a living tree changes into 'Snag' area and then into 'Stump' area, with no associated change in area. However, during this decay process additional woody microsities are created, such as 'Branches' and 'Logs' (Fig. 4). These new woody microsities cover areas formerly occupied by other non-woody microsite types. New logs are created when a snag breaks, and the area occupied by new logs was assumed to be a multiple of that of the snag area (cf. Fig. 4; 'area correction factors' explained in the Appendix). Correspondingly, the area covered by new logs was assumed to reduce the area of the other non-woody microsite types in proportion to their occurrence during the same time step. Similarly, the new area for the microsite type 'Pile of Branches' is created during the decay process of standing dead trees. Obviously, these transitions cannot be implemented using a standard matrix model approach.

Non-woody microsite types: All the other changes between microsite types were assumed to conform to the standard matrix model approach, and thus were calculated using transition probabilities in a matrix form. The fundamental assumptions of this approach are that (1) the rates of change depend only on the current state and not on previous (historical) states (i.e., first order Markov model) and (2) there is a finite number of microsite types (in our case, a total of 25 types).

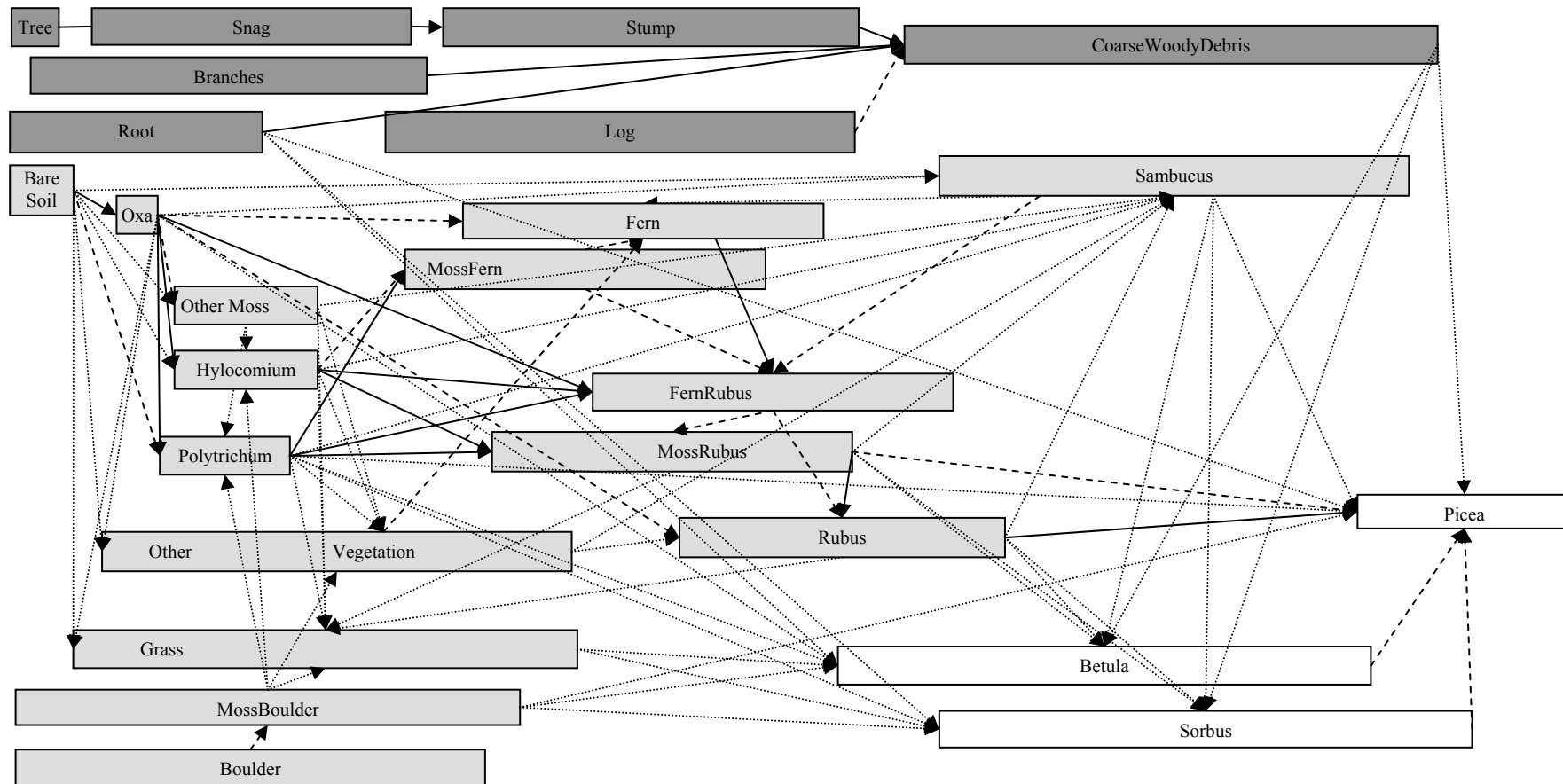

Fig. 3: Schematic diagram of the simulation model. The boxes represent the 25 microsite types included in the model. Dark grey boxes are woody microsite types, light grey boxes are types dominated by stones, bare soil or ground vegetation, and white boxes are types dominated by trees. For the montane elevational level all transitions between microsite types are shown with arrows (exception: no arrows are drawn from non-woody microsite types to 'Logs' or 'Branches'): thick arrows denote frequent transitions (annual probability > 5%), dashed arrows less frequent transitions (1-5%) and dotted arrows rare transitions (< 1%). The width of the boxes represents differences in the residence times of the various microsite types (except in the case of Picea).

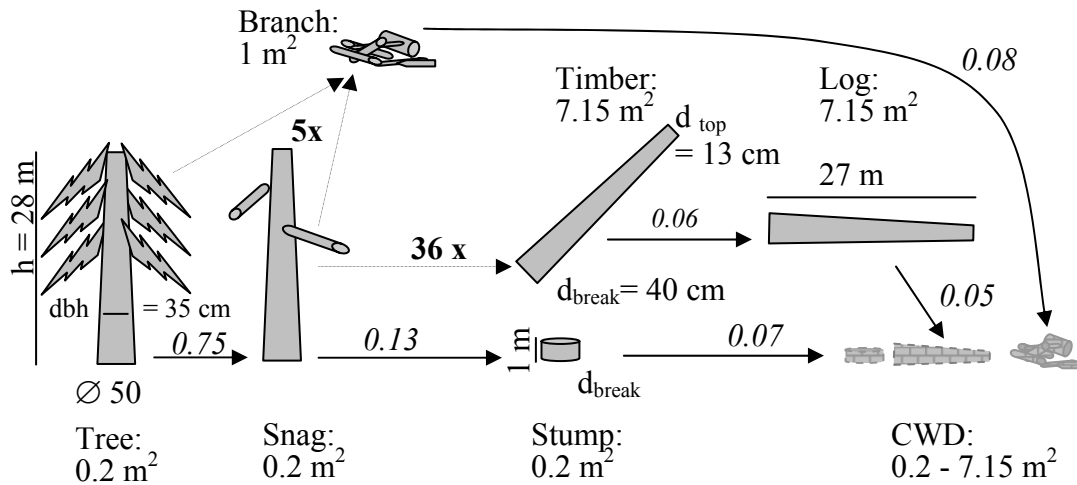

Fig. 4: Decay of a dead tree: sketch of the area occupied by different woody microsite types at the soil surface. For the microsite types ‘Branches’ and ‘Timber’ / ‘Logs’ the area correction factor applied in the model is shown (for calculation, see Appendix). Italicised are transition probabilities between these woody microsite types (for the derivation, see Appendix). The width of the tree, snag, and stump is enlarged in the picture.

In the next sections, the derivation of the initial values and parameters are explained. For the non-woody microsite types, two sets of initial values and parameters were estimated; one for the entire montane elevational level (1200- 1400 m a.s.l.) and one for the subalpine level (1450-1600 m). This division seemed appropriate due to the different structures of the forest stands (different forest associations) and the different vegetation cover before and after tree die-back (cf. Fig. 2 and Introduction section).

4.2 Model initialisation

The model was used to simulate an area of 100 m^2 , and it was initialised with the conditions inferred for the Norway spruce stands in 1993. At that time, *Picea trees* had already been attacked by bark beetles but still contained their needles, and therefore it is reasonable to assume that the ground vegetation was still similar to that in a living stand.

4.2.1 Woody microsite types (montane and subalpine stands)

In the transects, 513-560 living trees and snags per ha were observed in 2000, with an average diameter at breast height of 35 cm, a projected diameter at the soil surface of 50 cm and an average height of living or dead unbroken trees of 28 m (cf. Fig. 4) at all elevational levels (Kupferschmid Albisetti *et al.* 2003). For the microsite type ‘Tree’, we therefore assumed that 5 trees were present per 100 m^2 , each of them

covering a basal area of about 0.2 m² at the soil surface (cf. Fig. 4), resulting in a cover of 1% for the microsite type ‘Tree’. Furthermore, we assumed that no snags and no fresh stumps (microsite type ‘Stump’) had been present in 1993, but only rotten stumps and rotten logs (microsite type ‘Coarse Woody Debris’, only called ‘CWD’ below).

In 2000, 68 rotten stumps ha⁻¹ were present at the montane level, and 10 rotten stumps ha⁻¹ at the subalpine level (Kupferschmid Albisetti *et al.* 2003). In the subalpine transects, the rotten stumps together with the rotten logs covered an area of about 1% (Fig. 2). At the montane elevational level, the frequency of the microsite type ‘CWD’ was estimated to zero because most rotten logs and also most decaying stumps were covered by *Rubus idaeus* (Fig. 2). However, since the montane level had been more exploited than the subalpine level, we expected fewer logs (but more stumps) on the montane level, and therefore 1% was judged to be a good estimate also of the abundance of the microsite type ‘CWD’ on the montane Gandberg for the year 1993. We assumed very few branches on the soil and hence set the initial frequency of the microsite type ‘Branches’ to zero.

Finally, an estimate of the microsite type ‘Root’ had to be calculated. *Picea abies* trees on the Gandberg exhibited large amounts of roots at the soil surface or on boulders. We assumed that the microsite type ‘Root’ occupies 0.8 m² per tree, thus resulting in 4% total ‘Root’ cover for the 5 trees/100 m² (Table 1).

4.2.2 Non-woody microsite types on the montane level

The non-woody microsite types include all the other microsite types present on the Gandberg forest such as ‘Boulders’, ‘Bare Soil’ and all types with plant cover. Almost no quantitative information was available on the frequency of these microsite types prior to tree death. The only data available were from three 1 m x 1 m vegetation cover assessments carried out by Kägi (1992) and from the 24 permanent plots since summer 1994 (Fig. 5, Kupferschmid 2002). The following strategy was used to derive the initialisation values for the year 1993 (Table 1): (1) from the comparison of the data of Kägi (1992) with the permanent plot data in 1994, it seemed likely that only the cover of *Oxalis acetosella* had increased considerably between tree death and spring 1994, as a consequence of tree defoliation; (2) the permanent plots were quite small, and hence they neither included snags nor large boulders. Therefore, the frequency of these microsite types could not be estimated from the permanent plot data. Instead, the transect data recorded in the year 2000 (Fig. 2) were used to estimate the microsite types ‘Tree’, ‘Snag’, ‘Stump’, ‘Root’, ‘Coarse Woody Debris’, ‘MossBoulder’ and ‘Boulder’.

Table 1: Estimated microsite type frequencies for the years 1993 and 2001 on the montane and subalpine level. Data sets for the montane level are based on the permanent plots and the strip transects, the ones for the subalpine level only on the strip transects (cf. Fig. 2). The microsite type ‘Vegetation’ was mostly composed of *Senecio ovatum* at the montane level and *Vaccinium* at the subalpine level. ‘Other Mosses’ included mostly liverworts on the montane level and *Sphagnum* on the subalpine level. The estimations for the year 1993 were used as initialisation data in the model, those of 2001 for model verification.

Microsite types names	abbreviation	Estimates [%]			
		montane		subalpine	
		1993	2001	1993	2001
Tree	Tre	1.0	0.0	1.0	0.0
Snag	Sna	0.0	0.5	0.0	0.5
Stump	Stu	0.0	0.4	0.0	0.4
Branch	Bra	0.0	2.0	0.0	2.0
Log	Log	0.0	3.6	0.0	3.6
Root	Roo	4.0	2.3	4.0	2.3
CWD	CWD	1.0	3.0	1.0	3.0
Bare Soil	Soi	51.0	0.6	64.0	7.0
Oxalis	Oxa	20.0	0.4	1.7	1.0
Polytrichum	Pol	5.0	5.7	1.0	30.0
Hylocomium	Hyl	1.0	1.5	0.1	0.2
Moss	Mos	1.5	0.4	0.1	2.0
MossBoulder	MoB	4.0	4.5	2.0	2.2
Boulder	Bou	9.0	8.0	5.0	4.0
MossFern	MoF	0.0	6.5	0.7	14.0
Fern	Fer	0.0	3.0	3.0	14.0
FernRubus	FeR	0.0	27.5	0.1	0.5
Rubus	Rub	0.0	11.0	0.1	0.3
MossRubus	MoR	0.0	14.0	0.1	0.5
Sambucus	Sam	0.0	0.2	0.6	0.6
Other Vegetation	Veg	2.5	4.0	5.5	2.6
Grass	Gra	0.0	0.5	10.0	8.5
Betula	Bet	0.0	0.2		
Sorbus	Sor	0.0	0.1	0.0	0.4
Picea	Pic	0.0	0.2	0.0	0.4
all		100.0	100.0	100.0	100.0

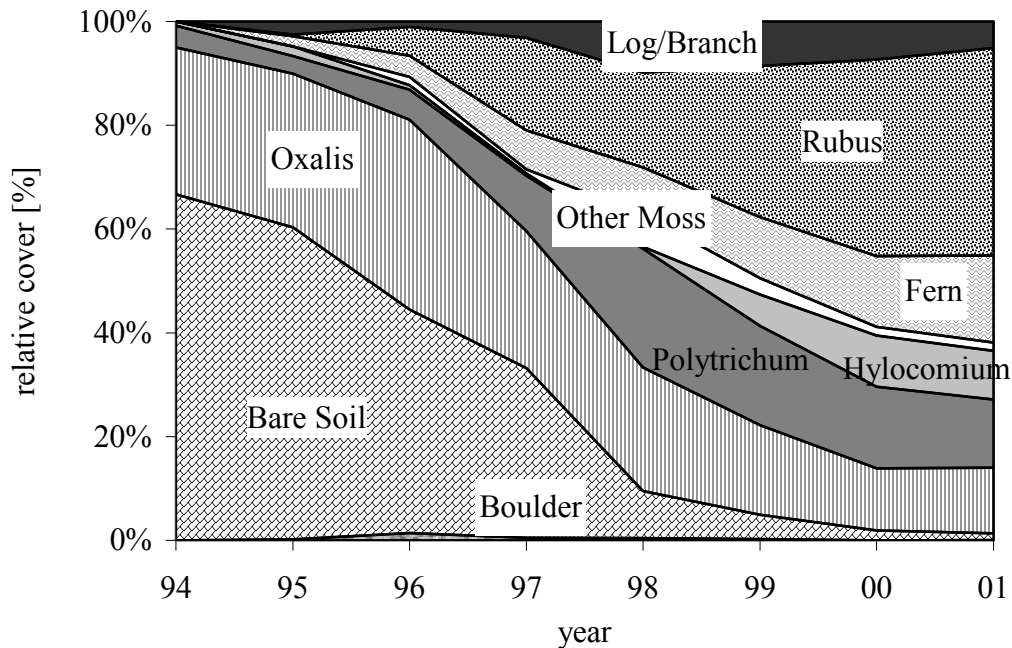

Fig. 5: Succession in the permanent plots in the Gandberg. Only the cover of the most frequent plants, boulders, bare soil and logs was used here to calculate total cover, which exceeded 200%. Note that these are not microsite types, but percentage of areas covered with a plant in percent of total cover (sum of all these percentages). Modified after Kupferschmid (2002).

4.2.3 Non-woody microsite types on the subalpine level

Model initialisation values for the subalpine level are summarised in Table 1. In contrast to the montane level, the initialisation values of the subalpine level were estimated from the cover of the microsite types underneath the groups of living *Picea abies* trees in 2000 in the transects at the upper subalpine level (living stands, Fig. 2). *Polytrichum formosum* and *P. alpinum* were far more abundant than all the other mosses (Kupferschmid 2001). We therefore assigned almost all (i.e. 98%) of the frequency of moss microsite types to the microsite type ‘Polytrichum’.

4.3 Model parameterisation

4.3.1 Transition probabilities involving woody microsite types

In the model, an artificial state ‘Timber’ was defined to allow for a better simulation of the decay process from snags via ‘hanging’ logs (= ‘Timber’) to the microsite type ‘logs on the soil surface’ (= ‘Logs’). Data from the snag and log measurements in the strip transects (Kupferschmid Albisetti *et al.* 2003) were used to estimate the decay parameters (cf. Fig. 4, details of estimation see Appendix).

4.3.2 Transition probabilities of non-woody microsite types at the montane level

We first used the ground-vegetation development observed in the permanent plots from 1994 to 2001 (Fig. 5, Kupferschmid 2002) to parameterise the matrix model. The transition probabilities are shown in Table 2. They were estimated using:

1. the microsite type distributions in 1993 and in 2001 (Table 1), which were estimated based on the proportions of microsite types in the permanent plots (Fig. 1 and 5) and in transects at the montane and upper montane elevational level (Fig. 2).
2. the assumed self-replacement probabilities of microsite types (consisting of residence times and transitions into ‘Logs’ and ‘Branches’, values in the diagonal of Table 2). They were derived from the succession in the permanent plots (Table 1 and Fig. 5) and additional information from a literature survey.
3. additional assumptions regarding the possible transitions between all the non-woody microsite types, that were based on the ground-vegetation succession in the permanent plots (Table 1 and Fig. 5) and data from literature.

In the Appendix, the derivation of every single transition probability is explained in detail.

Table 2 (next page): Transition matrix for the montane elevational level with all transition probabilities between non-woody microsite types. Abbreviations of the microsite types are listed in Table 1. Self-replacement transition probabilities (upper values) and the temporary constant transitions into the microsities ‘Logs’ and ‘Branches’ (lower values) are listed in the diagonal of the matrix, even though they have not been implemented in the model built on the software STELLA®. For the estimation of the transition probabilities, we refer to the Appendix. The microsite type ‘Vegetation’ includes mostly *Senecio ovatus* together with some *Galium odoratum*, *Galeopsis tetrahit* and *Epilobium montanum*, or very small (< 1%) amounts of *Vaccinium myrtillus*.

Table 2

Microsites	Soi	Oxa	Pol	Hyl	Mos	MoB	Bou	MoF	Fer	FeR	Rub	MoR	Sam	Veg	Gra	Bet	Sor	Pic
Soi	0.333 +0.130	0	0	0	0	0	0	0	0	0	0	0	0	0	0	0	0	0
Oxa	0.5	0.252 +0.130	0	0	0	0	0	0	0	0	0	0	0	0	0	0	0	0
Pol	0.02	0.42	0.545 +0.065	0	0.005	0.005	0	0	0	0	0	0	0	0	0	0	0	0
Hyl	0.005	0.06	0	0.598 +0.065	0.005	0.001	0	0	0	0	0	0	0	0	0	0	0	0
Mos	0.005	0.02	0	0	0.598 +0.065	0	0	0	0	0	0	0	0	0	0	0	0	0
MoB	0	0	0	0	0	0.959 +0.03	0.02	0	0	0	0	0	0	0	0	0	0	0
Bou	0	0	0	0	0	0	0.95 +0.03	0	0	0	0	0	0	0	0	0	0	0
MoF	0	0	0.06	0.05	0.15	0	0	0.9 +0.03	0	0	0	0	0	0	0	0	0	0
Fer	0	0.02	0	0	0	0	0	0.05	0.9 +0.03	0	0	0	0.005	0.01	0	0	0	0
FeR	0	0.07	0.2	0.2	0.09	0	0	0.02	0.07	0.9 +0.03	0	0	0.01	0	0	0	0	0
Rub	0	0.02	0	0	0	0	0	0	0	0.05	0.876 +0.03	0.06	0	0.005	0	0	0	0
MoR	0	0	0.12	0.08	0.08	0	0	0	0	0.02	0	0.896 +0.03	0	0	0	0	0	0
Sam	0.001	0.001	0.001	0.001	0.001	0	0	0	0	0	0.001	0.001	0.952 +0.03	0.005	0	0	0	0
Veg	0.005	0.005	0.005	0.005	0.005	0.001	0	0	0	0	0	0	0	0.95 +0.03	0	0	0	0
Gra	0.001	0.001	0.001	0.001	0.001	0.001	0	0	0	0	0.001	0.001	0	0	0.96 +0.03	0	0	0
Bet	0	0.001	0.001	0	0	0.001	0	0	0	0	0.001	0.001	0.001	0	0.005	0.97	0	0
Sor	0	0	0.001	0	0	0.001	0	0	0	0	0.001	0.001	0.001	0	0.005	0	0.97	0
Pic	0	0	0.001	0	0	0.001	0	0	0	0	0.09	0.01	0.001	0	0	0.03	0.03	1

Table 3:

Microsites	Soi	Oxa	Pol	Hyl	Mos	MoB	Bou	MoF	Fer	FeR	Rub	MoR	Sam	Veg	Gra	Bet	Sor	Pic
Soi	0.618 +0.13	0	0	0	0	0	0	0	0	0	0	0	0	0	0	0	0	0
Oxa	0	0.801 +0.13	0	0	0	0	0	0	0	0	0	0	0	0	0	0	0	0
Pol	0.2	0.04	0.852 +0.065	0	0	0.01	0	0	0	0	0	0	0	0	0	0	0	0
Hyl	0.001	0	0	0.872 +0.065	0	0	0	0	0	0	0	0	0	0	0	0	0	0
Mos	0.005	0	0	0	0.9 +0.065	0	0	0	0	0	0	0	0	0	0	0	0	0
MoB	0	0	0	0	0	0.958 +0.03	0.02	0	0	0	0	0	0	0	0	0	0	0
Bou	0	0	0	0	0	0	0.95 +0.03	0	0	0	0	0	0	0	0	0	0	0
MoF	0	0	0.07	0.06	0	0	0	0.929 +0.03	0	0	0	0	0	0.05	0	0	0	0
Fer	0.035	0.02	0	0	0	0	0	0.04	0.969 +0.03	0	0	0	0	0.04	0	0	0	0
FeR	0.001	0.001	0.001	0.001	0	0	0	0.001	0.001	0.965 +0.03	0.005	0.001	0	0	0	0	0	0
Rub	0.001	0.001	0	0	0	0	0	0	0	0	0.96 +0.03	0	0.005	0	0	0	0	0
MoR	0	0	0.001	0.001	0	0	0	0	0	0	0	0.967 +0.03	0.005	0	0	0	0	0
Sam	0.001	0.001	0	0	0	0	0	0	0	0.005	0.005	0.001	0.95 +0.03	0	0	0	0	0
Veg	0.001	0.001	0	0	0	0	0	0	0	0	0	0	0	0.878 +0.03	0	0	0	0
Gra	0.005	0.005	0.005	0.001	0.035	0	0	0	0	0	0	0.001	0	0	0.969 +0.03	0	0	0
Bet	0	0	0	0	0	0	0	0	0	0	0	0	0	0	0	0	0	0
Sor	0.001	0	0.001	0	0	0.001	0	0	0	0	0	0	0.005	0.001	0.001	0	0.97	0
Pic	0.001	0	0.005	0	0	0.001	0	0	0	0	0	0	0.005	0.001	0	0	0.03	1

Table 3 (preceeding page): Transition matrix for the subalpine elevational level. The structure of the table is identical to that of Table 2. The microsite type ‘Vegetation’ was mainly composed of *Vaccinium myrtillus*, beside some *Stellaria nemorum*.

4.3.3 Transition probabilities of non-woody microsite types at the subalpine level

A procedure similar to the one for the montane level was used (cf. Table 3). However, we used first of all the data from the strip transect at the upper subalpine level (Fig. 2), because no data from permanent plots were available for the subalpine level. The derivation of every single transition probability is explained in detail in the Appendix.

4.4 Model implementation and simulation experiments

The model was implemented with the software STELLA® (a software for model-building and simulation, High Performance Systems 2001), using array structures for the ‘matrix’ part of the model. Therefore, in contrary to a ‘real’ matrix, no self-replacement was modelled explicitly. For the integration, Euler’s method (cf. High Performance Systems 2001) was used with a time step of one year (discrete time model).

Firstly, simulations were performed over 8 years (1993-2001) with both sets of initial values and parameters, i.e. with the transition matrices parameterised for the montane and subalpine levels. These simulations enable (i) a verification of the model (comparison with data from the permanent plots from 1994-2001 and data from strip transects in 2000) and (ii) a validation of the model (comparison with independent data from 2001).

Secondly, long term simulations were performed; (i) to test the model in the long run (i.e., sensitivity analysis) and (ii) to evaluate the future succession of the montane and subalpine stands on the Gandberg.

5. Simulation results

5.1 Results for the montane level

5.1.1 Comparison with estimated microsite frequencies (model verification)

First, we compared the simulated microsite frequencies after 8 simulation years with the estimated microsite frequencies for the year 2001. The latter data were based on the frequencies in the permanent plots and the strip transects in the year 2001 (Table 1). Note that this is not a validation of the model, but a check whether the estimated parameters yield the simulation result we wanted, and therefore it is a check of the plausibility of the estimated transition probabilities for the Gandberg.

On the montane level, the simulated microsite frequencies (white bars in Fig. 6) corresponded well with the estimated microsite frequencies (Table 1). Only the amount of the microsite type ‘Picea’ was overestimated strongly in the model. As this discrepancy was due to the structure of the model, i.e. the constant transition parameter in the matrix, we considered our estimations of the transitions to be accurate enough (but see sensitivity analysis).

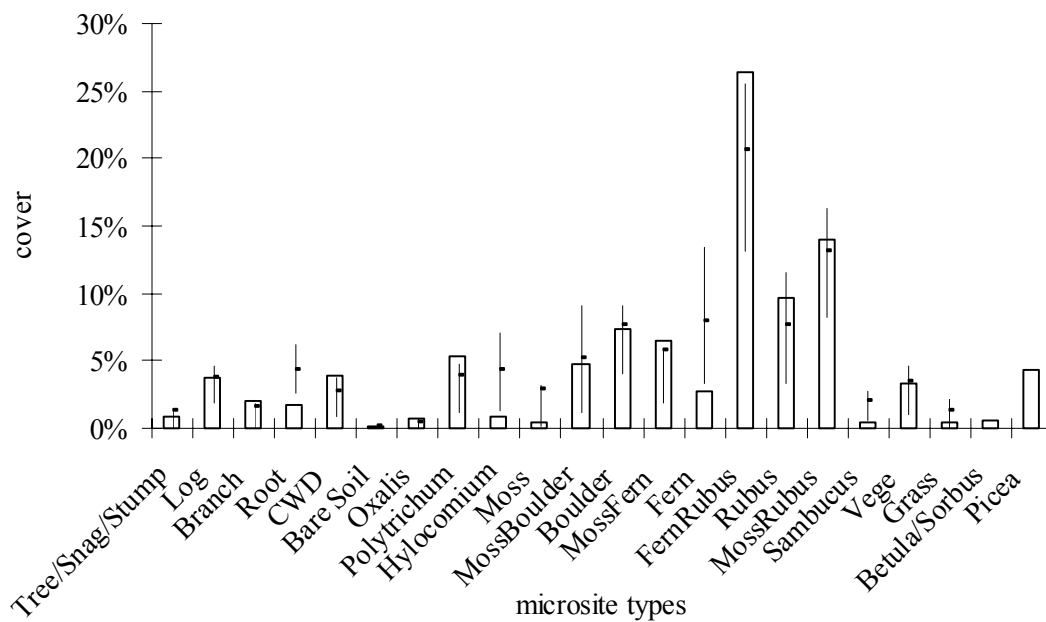

Fig. 6: Simulated microsite type frequencies after 8 simulation years (white bars) and measured microsite type frequencies in 2001 (validation data set represented by vertical lines), both for the montane level of the Gandberg. The ends of these vertical lines are the 25% and 75%-quartiles and the points the mean values of the 16 groups of lines (each containing four 10 m long lines) at the lower and upper montane level.

5.2.2 Comparison with independent field data (model validation)

In a next step, we compared the simulated frequencies after 8 simulation years with the microsite frequencies sampled along lines in 2001 on the two montane levels of the Gandberg (validation data set). An index of similarity (s) was calculated using Equation (1), similar to Bugmann (1994) and Badeck *et al.* (2001):

$$s = \frac{\sum_{i=1}^{22} (s_i)}{22}, \text{ where } s_i = 1 - \left(\frac{|validation_i - simulation_i|}{validation_i + simulation_i} \right) \quad (1)$$

where i stands for the 25 microsite types ('Tree', 'Snag' and 'Stump' were taken together and likewise 'Sorbus' and 'Betula'). The similarity index can take values between 0 and 1, where 1 is the result of total congruence of the simulation and the validation data. Results are shown in Table 4.

The general picture of the distribution of microsite types was quite similar after 8 years of simulation (white bars in Fig. 6) compared with the field data in 2001 (points in Fig. 6). Overall, the similarity indices s amounted to 0.6-0.7 (Table 4). However, with the assumptions we used, the model underestimated considerably ($s_i < 0.5$) the frequency of the microsite types 'Hylocomium', 'Other Mosses', 'Fern', 'Sambucus' and 'Grass' (Fig. 6 and Table 4). The frequencies of the microsite types 'Root' and 'Fern' were underestimated only slightly ($s_i = 0.6$, Table 4 and Fig. 6). In contrast, the frequency of the microsite type 'Picea' was overestimated considerably (Fig. 6), as it was not found at all in the Gandberg in 2001 (Fig. 6). However, it has to be kept in mind that in the microsite type assignment during the validation sampling, moss microsite types that contained *Picea* saplings of up to 40 cm in height were still counted as moss microsite types. Furthermore, the transition between 'Rubus' and 'Picea' is gradual in nature, i.e. there is a rather long time where both species co-dominate the microsite, whereas in the model this limit was sharp.

Applying Mann-Whitney U tests separately for each of the 25 microsities, no significant difference could be found between the mean frequency in the Gandberg in 2001 (16 groups, each representing a mean of 4 lines) and the simulated value 8 years after tree death ($p \gg 0.05$).

Table 4: Similarity index (s_i) for each microsite type i and each elevational level according to equation 1 (see text for details).

	Similarity index			
	montane		subalpine	
	lower	upper	lower	upper
Tree/Snag/Stump	0.7	1.0	0.7	0.8
Log	1.0	1.0	0.9	1.0
Branch	0.9	0.9	1.0	0.8
Root	0.6	0.6	0.6	0.4
CWD	0.7	0.9	0.8	0.8
Bare Soil	0.9	0.6	0.0	0.3
Oxalis	0.7	0.7	0.4	0.9
Polytrichum	1.0	0.7	0.8	1.0
Hylocomium	0.3	0.3	0.2	0.4
Moss	0.5	0.2	0.4	0.4
MossBoulder	0.9	1.0	1.0	0.3
Boulder	0.8	0.8	0.9	0.4
MossFern	0.6	0.8	1.0	0.9
Fern	0.6	0.4	0.9	1.0
FernRubus	0.9	0.9	0.1	0.8
Rubus	0.9	0.8	0.2	0.7
MossRubus	0.9	0.9	0.1	0.4
Sambucus	0.4	0.4	0.8	0.7
Other Vegetation	0.9	0.9	1.0	0.7
Grass	0.4	0.5	0.7	0.9
Total 20 microsites	0.7	0.7	0.6	0.7
Betula/Sorbus	0.0	0.0	0.0	0.0
Picea	0.0	0.0	0.0	0.0
Total 22 microsites	0.7	0.6	0.6	0.6

5.2 Results for the subalpine level

5.2.1 Comparison with estimated microsite frequencies (model verification)

The simulated microsite frequencies after 8 simulation years on the subalpine level (Fig. 7 B, white bars) coincide quite well with the estimated microsite frequencies on the upper subalpine level based on the transects (Table 1). Nevertheless, the amount of the microsite type ‘Grass’ was overestimated and the one of ‘Polytrichum’ underestimated with the model (Fig. 7 B, white bars) compared with the estimations for the subalpine level in 2001 (Table 1). However, as shown in Table 3, all transition probabilities into the microsite ‘Grass’ had already been estimated as being very or extremely small (Table 3).

Subsequently, the only change we could make was to change the transition probability from the microsite 'Polytrichum' into 'Grass' from 0.005 yr^{-1} to 0.001 yr^{-1} . We will evaluate this modification in the sensitivity analysis (below).

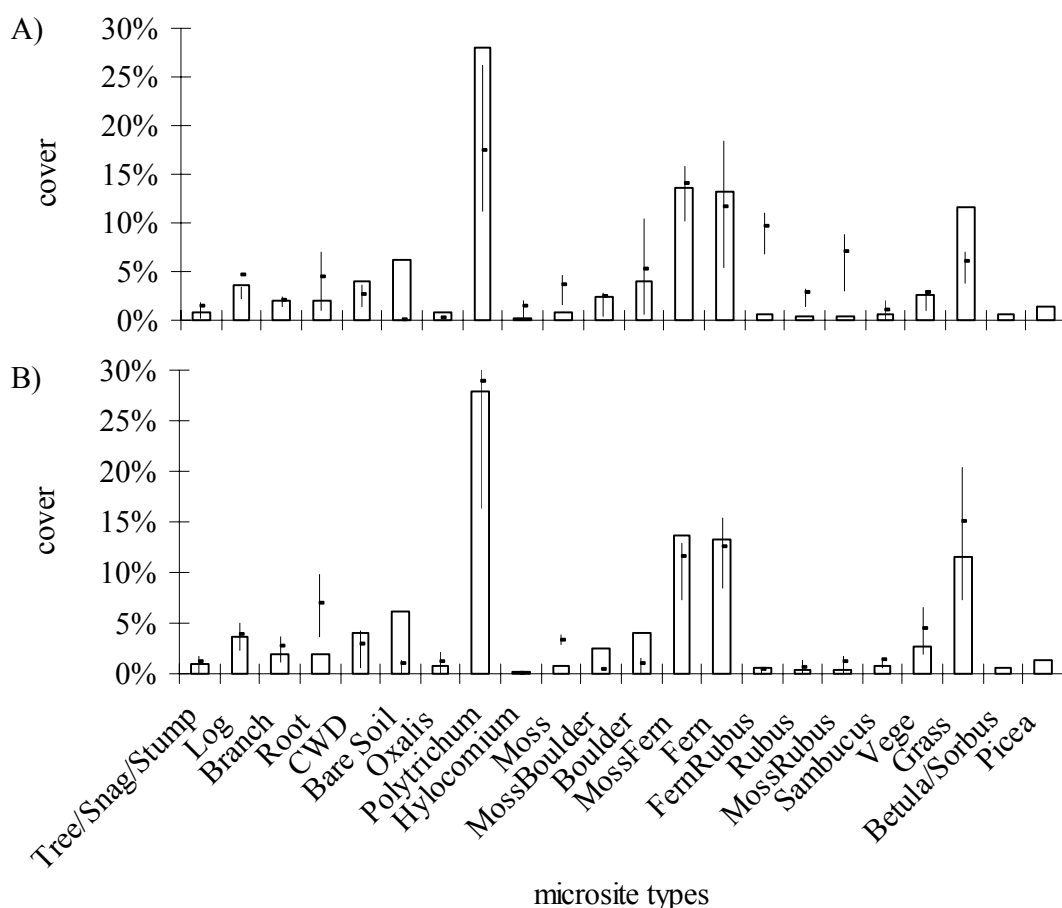

Fig. 7: Simulated microsite type frequencies for the subalpine elevational level after 8 simulation years (white bars) and microsite type frequencies from the lower subalpine (A) and the upper subalpine (B) level of the Gandberg in 2001 (validation data set represented by vertical lines). The ends of these vertical lines are the 25% and 75%-quartiles and the points the mean values of the 8 groups of lines (each containing four 10 m long lines).

5.2.2 Comparison with independent field data (model validation)

The general picture of the distribution of microsite types was also quite similar after 8 simulation years for the subalpine level compared with the field data sampled along lines in 2001 on the lower and upper subalpine levels (Fig. 7 A and B, Table 4: $s = 0.6-0.7$, $p \gg 0.05$ in Mann-Whitney U tests). However, with the assumptions we used, the simulation with the subalpine model considerably ($s_i < 0.5$) underestimated the frequency in the

microsite types ‘Root’, ‘Hylocomium’, ‘Other Mosses’ and MossRubus. In contrast, the microsite type ‘Bare Soil’ was overestimated (Fig. 7 and Table 4). As we parameterised our subalpine model with the data from the transect in the upper subalpine zone, the simulation considerably underestimated the microsite type frequencies of ‘FernRubus’, ‘Rubus’ and ‘MossRubus’ of the transition zone, i.e. the lower subalpine level (Fig. 7 A and Table 4). On the upper subalpine level, however, the site was less rocky than simulated, resulting in an overestimation of ‘Boulder’ and ‘MossBoulder’ in the model compared with field data (Fig. 7 B and Table 4).

5.3 Results for the time course of succession

5.3.1 Comparison with permanent plot data

For the montane level, we were able to compare the temporal sequence of the plant covers in the permanent plots (Fig. 5) with those of the microsite type frequencies during the first 8 simulation years (left part of Fig. 8 A). The occurrence of the various microsite types over time was in quite good agreement with the dominance of plants in the Gandberg forest. However, the microsite type ‘Rubus’ and in particular ‘CWD’ and ‘Picea’ emerged too quickly in the simulation (cf. Fig. 5 and left part of Fig. 8 A).

5.3.2 Sensitivity analysis

As mentioned above, the microsite type ‘Picea’ emerged too quickly and was overestimated in the model using the parameters for the montane level. We therefore firstly decreased stepwise the transition probability from the microsite type ‘Rubus’ into ‘Picea’ from 0.09 yr^{-1} (Table 2) to 0.05, 0.01, 0.005 and 0.001 yr^{-1} . No other transition probability was increased, resulting in an increase in the self-replacement probability of ‘Rubus’. After 8 simulation years, the frequency of the microsite type ‘Rubus’ increased from 10 to 11, 12, 13 and 13%, respectively, while ‘Picea’ decreased from 4 to 3, 1, 1 and 1%, respectively. After 25 years, the 90% decrease in the transition probability (from 0.05 to 0.005 yr^{-1}) resulted in a 66% decrease of the frequency of ‘Picea’ (21% vs. 7% ‘Picea’ cover), while the 99% decrease (from 0.09 to 0.001 yr^{-1}) resulted in a 82% decrease of the frequency of ‘Picea’ (28% vs. 5% ‘Picea’ cover). With the default transition probability of 0.09 yr^{-1} , the microsite type ‘Rubus’ never covered more than 14% of the area. In contrast, with a transition probability of only 0.001 yr^{-1} , ‘Rubus’ reached a maximum frequency of about 36% after 45 years of simulation.

In the model used with the parameters for the subalpine level, the microsite ‘Grass’ was overestimated considerably. We therefore secondly decreased stepwise the transition

probability from the microsite type ‘Polytrichum’ into ‘Grass’ from 0.005 yr^{-1} (Table 3) to 0.001 yr^{-1} . Also in this case, the self-replacement probability was increased implicitly. This modification caused an increase in the frequency of ‘Polytrichum’ of 1% and a decrease in ‘Grass’ of the same amount. Both changes lasted from the 7th year of simulation until the end of the simulation (25 years).

These two examples of sensitivity analyses show that our model is fairly sensitive to the values of the transition probabilities. However, as the simulation results match well (1) the estimated frequencies in 2001 and (2) the actual frequencies in the Gandberg (validation data set), we are confident that the model can be used with the current parameter set for the montane and the subalpine levels to simulate the microsite frequencies of about the first 25 years (see below). Afterwards, the uncertainty in the simulation results probably becomes too large.

Theoretically, the steady state of this modified matrix model is a 100% dominance of the microsite type ‘Picea’.

5.3.3 Simulations over 25 years

Simulation results over longer time periods (25 years) are shown in Figures 8 A and B. At the montane level, the various microsite types with raspberry (*Rubus idaeus*) are projected to dominate the ground vegetation also in the future (Fig. 8 A). However, according to the model, *Rubus* will slowly be substituted by a new forest dominated almost exclusively by *Picea abies*. The microsite types ‘Logs’, ‘Branches’ and ‘Coarse Woody Debris’ (CWD) will cover a maximum of 30% of the area on both the montane and the subalpine level (Fig. 8 A and B).

On the subalpine level, mosses will probably be dominant only for few additional years. Afterwards microsite types with ferns will quickly become dominant, while grasses will always co-dominate (Fig. 8 B). These simulation results suggest that *Picea abies* will establish at the subalpine level much more slowly than at the montane level (Fig. 8).

A) montane level

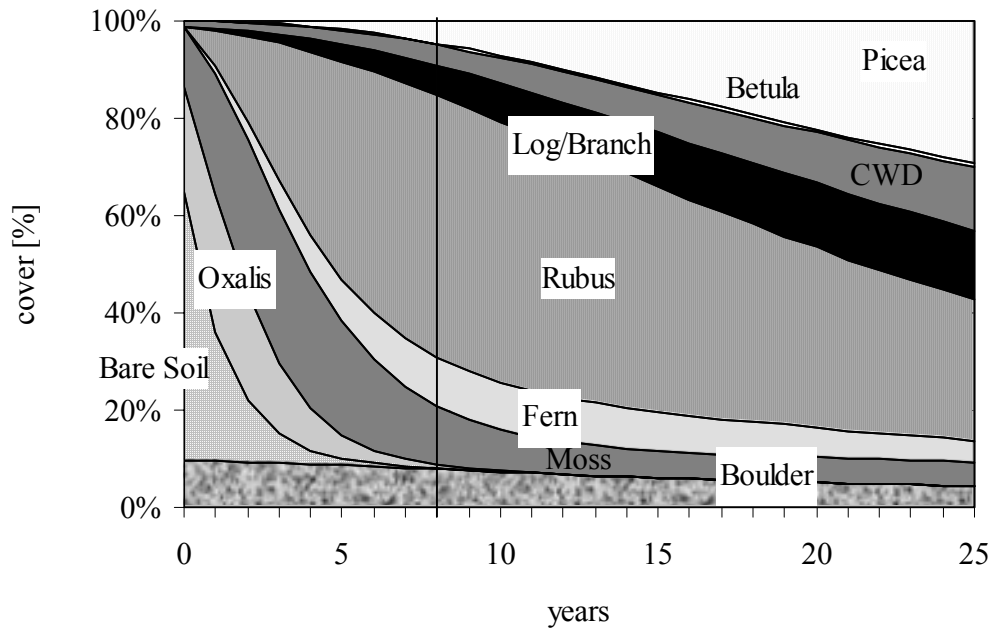

B) subalpine level

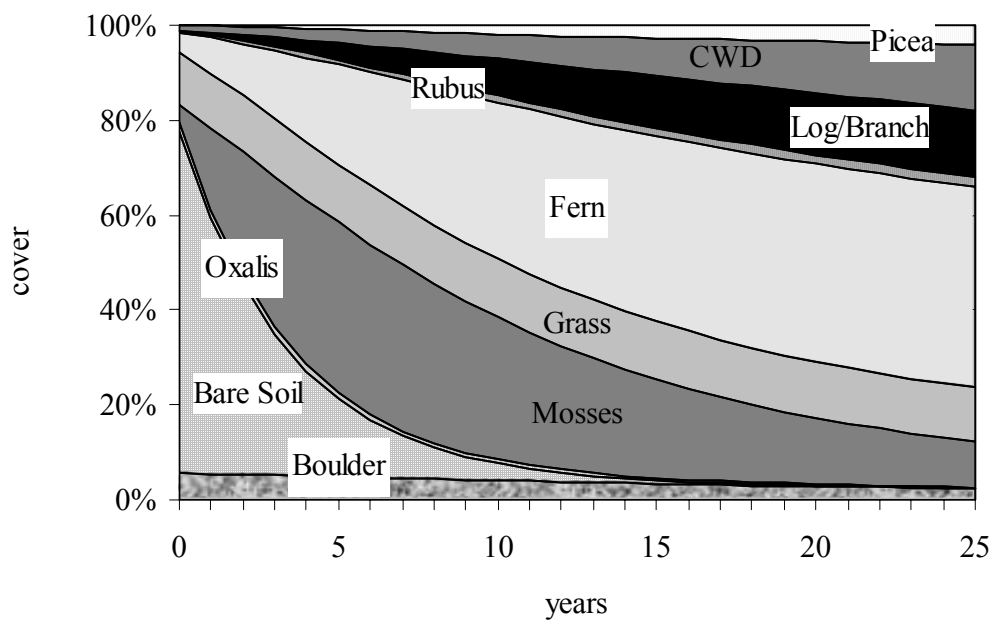

Fig. 8: Short-term simulation of the frequencies of the most important microsite types on the montane level (A) and subalpine level (B). Some microsite types were pooled for better comparison of the first 8 years with the results from permanent plots of the Gandberg (Fig. 5) and simpler conclusions for the later years (e.g. Rubus represents 'Rubus', 'MossRubus' and 'FernRubus').

6. Discussion

The two elevational levels on the Gandberg in the northern Swiss Pre-Alps represent case studies for two of the most frequent successional pathways after beetle-caused conifer tree die-back, with an invasion by *Rubus idaeus* at the montane level as opposed to a strong dominance by mosses, ferns and *Calamagrostis villosa* at the subalpine level.

6.1 Accuracy of the presented model

Our model was developed to reproduce the observed vegetational patterns on both elevational levels and to project the future short-term succession. The first goal was achieved accurately for the development of the ground vegetation at both the montane and the subalpine level (Figs. 6 and 7). Thus, we conclude that the modified matrix-model approach used here is quite powerful for such purposes.

The most common criticism of matrix models is their assumption of stationarity of the transition parameters (e.g. discussion in Usher 1981). For the specific case of matrix models investigated here, however, the assumption of stationarity is probably not critical, because the model is used for a short time interval (max. 25 years) only. In addition, the most variable transitions (e.g. from all the non-woody microsite types into ‘Logs’ and ‘Branches’) were treated with an approach that differs from that of a standard matrix model (i.e., distinction between woody and non-woody microsite types). Nevertheless, due to the nature of our database, it was difficult to estimate the transition probabilities into those microsite types that will become quantitatively more important in the future, such as pioneer trees and ‘Picea’.

For the montane level, we assumed that *Rubus idaeus* will be replaced by *Picea abies*. We propose that this is a reasonable assumption because pioneer trees were absent almost entirely in the early succession on the Gandberg, whereas *Picea* saplings were already present under *Rubus* in 2001 (Kupferschmid *et al.* 2002). However, such a succession will probably only happen where advanced tree regeneration is present, or where *Picea* seed years in surrounding stands occur in the first few years after the beetle attacks. If tree regeneration does not establish quickly after tree die-back, competition by the ground vegetation may be too strong for *Picea*, and the *Rubus idaei* associations will probably dominate a site much longer. Thus, a fast succession towards a new tree stand requires ‘windows of opportunity’, which conforms with findings from several other studies (cf. Bugmann and Weisberg 2003, Sage *et al.* 2003). As a corollary, we conclude

that it is quite important to model tree regeneration in more detail, and we will focus on this problem in a companion paper (Kupferschmid *et al.* submitted).

For the subalpine level, it was considerably more difficult to make appropriate assumptions for the long-term simulation. If our assumptions are correct, ferns together with grasses will be the dominant species for a fairly long period into the future (Fig. 8 B). In addition, more than 20% of the surface will be covered by logs and coarse woody debris 20 years after tree mortality (Fig. 8 B). It can be expected that the rotten wood and stumps will be important as 'safe sites' for tree regeneration in the coming decades (cf. Reif and Przybilla 1995, Szewczyk and Szwargrzyk 1996, Nüsslein and Faisst 1998, Ulanova 2000a). However, the amount of future *Picea abies* recruitment on coarse woody debris will depend mostly on the availability of seeds and therefore on the seed production of the few surviving reproductive trees, or on long-distance transport from the surviving stands surrounding the snag stands. Again, this underlines the importance of modelling tree regeneration in more detail.

Although it is clear that long-term simulation studies with the model would gain plausibility if seed dispersal, tree germination, growth and mortality were modelled explicitly, we conclude that the model presented here demonstrates that it is possible to accurately simulate the present vegetation pattern based on rather simple assumptions, and to provide a good basis for projecting the temporal development of two montane and subalpine snag stands.

6.2 When to use which model parameter set?

It would be desirable to know or to be able to predict from certain criteria which succession will take place directly after the die-back of trees; (1) *Rubus idaeus* invasion or (2) mosses then fern and *Calamagrostis* dominance. Based on this knowledge, our montane matrix (Table 2) could be used to simulate a *Rubus* invasion, and our subalpine matrix (Table 3) for the succession with fern and grass dominance. However, at the moment such criteria are missing.

We can only speculate about the reasons for the invasion of *Rubus idaeus* that occurred at the montane level, but not (yet) at the subalpine level of the Gandberg. Often, *Rubus idaeus* has been observed to quickly invade a site by sexual reproduction after disturbance. *Rubus* invasion by vegetative spread would be a much slower process. Peterson and Carson (1996) proposed that the abundance of characteristic seed-bank pioneer species like *Rubus* spp. is dependent on propagule availability, which in turn is

determined by forest age and size (Peterson and Carson 1996). In experiments, fresh seeds of *Rubus idaeus* did not germinate easily (Giannini 1972), but if the seed coats had been damaged during long-term soil storage in the seed bank and/or had experienced years of scarification, *Rubus* seeds germinated well (Lautenschlager 1997). We thus conclude that 'old' seeds from a former *Rubus* scrub need to be present to cause a fast and excessive *Rubus* invasion after tree die-back. This was probably the case at the montane level of the Gandberg, as this site had been clear-cut in the 19th century. Furthermore, after Lautenschlager (1997) *Rubus* seedlings will establish and expand successfully only where ample light, nutrients and moisture are available. Such conditions are commonly met following harvesting, windthrow (Fischer and Jehl 1999) and probably also after beetle infestations. It is not clear whether the lack of *Rubus* dominance in some sites (e.g. Yeager and Riordan 1953, Baker and Kemperman 1974, Schulz 1996, Wurz and Wahrenbrock 2000) could be due to the absence of historical clear-cutting or other disturbances. However, in sites above a certain elevation and probably also in pristine forests where grasses were present before the tree die-back, *Rubus* seemed to be restricted mostly to the scattered mounds of uprooted trees (Jehl 1995, Reif and Przybilla 1995, Heurich 2001, Kupferschmid 2001).

According to Lieffers and Stadt (1994), *Calamagrostis canadensis* was virtually eliminated from stands or was greatly reduced when only 10% or 40% of full sunlight was available at the forest floor. As *Calamagrostis canadensis* and *C. villosa* are ecologically comparable, we surmise that on the Gandberg, *Calamagrostis* was probably absent in the dense stands at the montane level prior to the beetle attacks (growing stock of about 820 m³ ha⁻¹, Kupferschmid Albisetti *et al.* 2003). However, in the more open stands at the subalpine level (590 m³ ha⁻¹, Kupferschmid Albisetti *et al.* 2003), it is likely that *Calamagrostis* had already dominated the open places before the death of the trees (Fig. 2, grey bars). Eight years after tree mortality, grasses were still restricted to these areas and could not actually expand (Fig. 2, white bars). This is in contrast to beetle-killed stands in Colorado where grasses and sedges had nearly twice the density in stands with dead trees compared to stands with living trees (Yeager and Riordan 1953).

We conclude that our model with the transition matrix parameterised for the montane level can be used to simulate the succession in beetle-killed stands which are vulnerable to *Rubus* invasions, such as (1) dense stands that had been exposed to clear-cuts or heavy disturbances in the past decades to centuries, (2) stands that already have some *Rubus* patches, or (3) stands that lack a dense vegetation cover, in particular where grasses and sedges are rare or even absent. In contrast to the 'montane' parameterisation, our model with the transition matrix parameterised for the subalpine level can be used to simulate the

succession in other beetle-killed Norway spruce stands. However, it is clear that such an empirical model approach has to be adapted to new situations by at least partly re-parameterising the transition matrix and the decay parameters.

Acknowledgement

We thank Marc Battaglia, Ulrich Wasem, Massimo Albisetti, Stefan Landolt and the Forest Service of Schwanden for their valuable help during the fieldwork. We are also grateful to Peter Brang and Walter Schönenberger for their helpful advice throughout the study. This work was supported by the Foundation for the Advancement of Forest and Wood Research, the government of the canton Glarus and the Swiss Federal Research Institute WSL.

7. References

- Aavisksoo K. (1993): Changes of plant cover and land use types (1950's to 1980's) in three mire reserves and their neighbourhood in Estonia. *Landsc. Ecol.* **8**(4): 287-301.
- Badeck F.W., Lischke H., Bugmann H., Hickler T., Hönninger K., Lasch P., Lexer M.J., Mouillot F., Schaber J. & Smith B. (2001): Tree species composition in European pristine forests: comparison of stand data to model predictions. *Clim. Chang.* **51**: 307-347.
- Baker B.H. & Kemperman J.A. (1974): Spruce beetle effects on a white spruce stand in Alaska. *J. For.* **72**: 423-425.
- Batzer H.O. & Popp M.P. (1985): Forest succession following a spruce budworm outbreak in Minnesota. *For. Chron.* **61**(2): 75-80.
- Bebi P., Kienast F. & Schönenberger W. (2001): Assessing structures in mountain forests as a basis for investigating the forests dynamics and protective function. *For. Ecol. Manage.* **145**(1-2): 3-14.
- Beudert B. (1999): Veränderungen im Stoffhaushalt eines abgestorbenen Fichtenökosystems im Forellenbachgebiet des Nationalparks Bayerischer Wald. *Einzugsgebiet Grosse Ohe - 20 Jahre hydrologische Forschung im Nationalpark Bayerischer Wald, Symposiumsbericht*. Nationalparkverwaltung Bayerischer Wald. 83-106.
- Botkin D.B., Janak J.F. & Wallis J.R. (1972): Some ecological consequences of a computer model of forest growth. *J. Ecol.* **60**: 849-872.
- Brang P. (1998): Early seedling establishment of *Picea abies* in small forest gaps in the Swiss Alps. *Can. J. For. Res.* **28**(4): 626-639.
- Brang P., Schönenberger W., Ott E. & Gardner B. (2001): Forests as protection from natural hazards. In: Julian Evans (ed.) *The forest handbook*. Blackwell Science. 53-81.

- Brown D. (1994): The development of woody vegetation in the first 6 years following clear-cutting of hardwood forest for a utility right-of-way. *For. Ecol. Manage.* **65**: 171-181.
- Bugmann H. (1994): On the ecology of mountainous forests in a changing climate: A simulation study. *PhD thesis*. ETH, Zürich. 258 p.
- Bugmann H. (2001): A review of forest gap models. *Clim. Chang.* **51**: 259-305.
- Bugmann H. & Weisberg P.J. (2003): Forest-ungulate interactions: monitoring, modeling and management. *J. Nat. Con.* **10**(4): 193-201.
- Canfield R.H. (1941): Application of the line interception method in sampling range vegetation. *J. For.* **39**: 388-394.
- Caswell H. (2001): *Matrix population models*. Sunderland, Mass. Sinauer Associates. 722p.
- Cavegn D. (1996): Zusammenhänge zwischen Vegetationsentwicklung und Fichtenansamung in kleinen Lücken im subalpinen Fichtenwald bei Sedrun. *Diplomarbeit*. Departement Forstwissenschaften, ETH, Zürich. 71 p.
- Cherrill A.J., McClean C., Watson P., Tucker K., Rushton S.P. & Sanderson R. (1995): Predicting the distributions of plant species at the regional scale: a hierarchical matrix-model. *Landscape Ecol.* **10**(4): 197-207.
- Cole E., Newton M. & Youngblood A. (1999): Regenerating white spruce, paper birch, and willow in south-central Alaska. *Can. J. For. Res.* **29**(7): 993-1001.
- Crawford H.S., Lautenschlager R.A., Stokes M.R. & Stone T.L. (1993): Effects of forest disturbance and soil depth on digestible energy for moos and white-tailed deer. *USDA For. Serv., Res. Pap.* **NE-682**: 1-13.
- Dauber E. & Kreuzer K. (1979): Die Ermittlung des Potentials forstlicher Reststoffe in der Bundesrepublik Deutschland. *Forstw. Cbl.* **98**: 289-297.
- Eichrodt R. (1969): Über die Bedeutung von Moderholz für die natürliche Verjüngung im subalpinen Fichtenwald. *Beih. Z. Schweiz. Forstver.* **45**: 122.
- Enright N. & Ogden J. (1979): Applications of transition matrix models in forest dynamics - *Araucaria* in Papua-New-Guinea and *Nothofagus* in New Zealand. *Aust. J. Ecol.* **4**(1): 3-23.
- Fischer A. & Jehl H. (1999): Vegetationsentwicklung auf Strumwurfflächen im Nationalpark Bayerischer Wald aus dem Jahre 1983. *Forstl. Forsch.ber. München* **176**: 93-101.
- Fleming R.A. (2000): Climate change and insect disturbance regimes in Canada's boreal forests. *World Resour. Rev.* **12**(3): 521-555.
- Forster B. (1993): Entwicklung der Borkenkäfersituation in den Schweizer Sturmschadengebieten. *Schweiz. Z. Forstwes.* **144**(10): 767-776.
- Forster B. (2001): Ausgedehnter Stehendbefall im Mittelland: Käferholz erkennen und richtig handeln. *Wald Holz* **8**: 72-74.
- Forstverwaltung Kt. Glarus (1949): Wirtschaftsplan über die Gemeindewaldungen von Schwanden (1. Revision). *Unveröffentlicht*. Forstverwaltung Kt. Glarus, Glarus.
- Giannini R. (1972): Ricerche sulla germinazione del seme di rovo, lampone ed epilobio. *Informat. Bot. Ital.* **4**: 165-166.
- Golser M. & Hasenauer H. (1997): Predicting juvenile tree height growth in uneven-aged mixed species stands in Austria. *For. Ecol. Manage.* **97**(2): 133-146.

- Harmon M.E., Franklin J.F., Swanson F.W., Sollins P., Gregory S.V., Lattin J.D., Anderson N.H., Cline S.P., Aumen N.G., Sedell J.R., Lienkaemper G.W., Cromack K., Cromack J. & Cummins K.W. (1986): Ecology of coarse woody debris in temperate ecosystems. *Adv. Ecol. Res.* **15**: 133-302.
- Hasenauer H., Burgmann M. & Lexer M.J. (2000): Konzepte der Waldökosystemmodellierung. *Cent.bl. gesamte Forstwes.* **117**(3/4): 137-164.
- Heurich M. (2001): Waldentwicklung im montanen Fichtenwald nach grossflächigem Buchdruckerbefall im Nationalpark Bayerischer Wald. In: Heurich (ed.) *Waldentwicklung im Bergwald nach Windwurf und Borkenkäferbefall*. Nationalparkverwaltung Bayerischer Wald, Grafenau. 99-176.
- High Performance Systems Inc. (2001): Stella Research Software. Hanover.
- Hillebrand K. & Leder B. (1995): Die Vogelbeere als eine interessante Mischbaumart für Fichten-Hochlagenbestände. *LÖBF-Jahresbericht*: 143-151.
- Hogget A. (2000): Western hemlock looper and forest disturbance in the ICHwk3 of the Robson Valley; Stage 2: The Effects of western hemlock looper - Report and silviculture recommendations. University of British Columbia. 93 p.
- Holeksa J. (1998): Rozpad drzewostanu i odnowienie swierka a struktura i dynamika karpackiego boru gornoreglowego (Breakdown of tree stand and spruce regeneration versus structure and dynamics of a Carpathian subalpine spruce forest). *Monogr. Bot.* **82**: 1-201 (English summary 201-209).
- Holsten E. & Burnside R. (1997): Forest Health in Alaska: An Update. *Western Forester* **42**(4): 8-9.
- Holsten E.H. (1990): Forest pest management report. Spruce beetle activity in Alaska, 1920-1989. *USDA For. Serv., Tech. Rep.* **10-90-18**: 1-28.
- Horn H.S. (1975): Markovian properties of forest succession. In: M.L. Cody & J.M. Diamond (eds.), *Ecology and evolution of communities*. The Belknap Press of Harvard University, Cambridge. 545.
- Huth A. & Ditzer T. (2000): Simulation of the growth of a lowland Dipterocarp rain forest with FORMIX 3. *Ecol. Model.* **134**: 1-25.
- Ishizuka M., Toyooka H., Osawa A., Kushima H., Kanazawa Y. & Sato A. (1998): Secondary succession following catastrophic windthrow in a boreal forest in Hokkaido, Japan: The timing of tree establishment. *J. Sust. For.* **6**(3/4): 367-388.
- Jehl H. (1995): Die Waldentwicklung auf Windwurfflächen im Nationalpark Bayerischer Wald. In: Nationalparkverwaltung Bayerischer Wald (ed.) *25 Jahre auf dem Weg zum Naturwald*. Nationalparkverwaltung Bayerischer Wald, Neuschönau. 112-146.
- Jehl H. (2001): Waldentwicklung nach Windwurf in den Hochlagen des Nationalpark Bayerischer Wald. In: Marco Heurich (ed.) *Waldentwicklung im Bergwald nach Windwurf und Borkenkäferbefall*. Nationalparkverwaltung Bayerischer Wald, Grafenau. 49-98.
- Kägi B. (1992): Pflanzensoziologische Karte des Gandbergwaldes. *Unveröffentlicht*, Forstdirektion Kt. Glarus, Glarus.
- Kaufmann E. (2001): Estimation of standing timber, growth and cut. In: Peter Brassel & Heike Lischke (eds.), *Swiss national forest inventory: methods and models of the second assesment*. Swiss Federal Research Institute WSL, Birmensdorf. 162-194.

- Kellomäki S. & Väisänen H. (1991): Application of a gap model for the simulation of forest ground vegetation in boreal conditions. *For. Ecol. Manage.* **42**: 35-47.
- Kramer H. & Krüger H.H. (1981): Vorrat und Nutzungsmöglichkeit forstlicher Biomasse in der Bundesrepublik Deutschland. *Forst- Holzwirt* **2**: 33-37.
- Kruys N., Jonsson B.G. & Stahl G. (2002): A stage-based matrix model for decay-class dynamics of woody debris. *Ecol. Appl.* **12**(3): 773-781.
- Kupferschmid A.D. (2001): Neues Leben im Totholzbestand auf dem Gandberg. In: Thomas Rageth (ed.) *Binding Preis für vorbildliche Waldpflege 2001: Vivian als Chance. Gemeinde Schwanden GL*. Sophie und Karl Binding Stiftung, Basel. 51-57.
- Kupferschmid A.D. (2002): Bark influence on vegetation development in a dead *Picea abies* mountain forest. In: Roberta Bottarin & Ulrike Tappeiner (eds.), *Interdisciplinary mountain research*. Blackwell Science, Berlin. 242-247.
- Kupferschmid A.D., Brang P., Schönenberger W. & Bugmann H. (submitted): Predicting tree regeneration in a *Picea abies* snag stand. *For. Sci.*
- Kupferschmid A.D., Schönenberger W. & Wasem U. (2002): Tree regeneration in a Norway spruce snag stand after tree die-back caused by *Ips typographus*. *For. Snow Landsc. Res.* **77**(1/2): 149-160.
- Kupferschmid Albisetti A.D. (in prep.): Succession in a protection forest after *Picea abies* die-back. *PhD thesis*. Departement of Forest Sciences, ETH, Zürich.
- Kupferschmid Albisetti A.D., Brang P., Schönenberger W. & Bugmann H. (2003): Decay of *Picea abies* snag stands on steep mountain slopes. *For. Chron.* **79**(2): 247-252.
- Lauber K. & Wagner G. (1996): *Flora Helvetica*. Verlag Paul Haupt, Bern.
- Lautenschlager R. (1997): Effect of perturbation and stimulants on red raspberry (*Rubus idaeus* L.) seed germination. *For. Chron.* **73**(4): 453-457.
- Leibundgut H. (1984): *Die natürliche Waldverjüngung*, 2 edition. Verlag Paul Haupt, Bern.
- Lieffers V.J., Macdonald S.E. & Hogg E.H. (1993): Ecology of and control strategies for *Calamagrostis canadensis* in boreal forest sites. *Can. J. For. Res.* **23**: 2070-2077.
- Lieffers V.J. & Stadt K.J. (1994): Growth of understory *Picea glauca*, *Calamagrostis canadensis* and *Epilobium angustifolium* in relation to overstory light transmission. *Can. J. For. Res.* **24**: 1193-1198.
- Märkl G. & Eglseer C. (2001): Verjüngungs- und Vegetationsentwicklung in Sturmwurf-Bannwäldern. In: *10 Jahre Waldentwicklung nach Sturm 'Wiebke': Untersuchungen im Fichten Sturmwurf-Bannwäldern Baden-Württembergs*. Forstliche Versuchs- und Forschungsanstalt Baden-Württemberg, Freiburg. 61-197.
- Matsuoka S.M., Handel C.M. & Ruthrauff D.R. (2001): Densities of breeding birds and changes in vegetation in an Alaskan boreal forest following a massive disturbance by spruce beetles. *Can. J. Zool.* **79**: 1678-1690.
- Mayer H. (1960): Bodenvegetation und Naturverjüngung von Tanne und Fichte in einem Allgäuer Plenterbestand. *Ber. Geobot. Inst. ETH Stift. Rübel* **31**: 19-24.
- Mencuccini M., Piussi P. & Zanzi Sulli A. (1995): Thirty years of seed production in a subalpine Norway spruce forest: Patterns of temporal and spatial variation. *For. Ecol. Manage.* **76**: 109-125.
- Monserud R.A. & Sterba H. (1996): A basal area increment model for individual trees growing in even- and uneven-aged forest stands in Austria. *For. Ecol. Manage.* **80**(1-3): 57-80.

- Morrison M.L. & Raphael M.G. (1993): Modeling the dynamics of snags. *Ecol. Appl.* **3**(2): 322-330.
- Newsome T., Armleder H., Waterhouse M. & Steen O. (1995): Fifth year results from group selection harvesting in the ESSFwc3 on windthrow, artificial and natural regeneration. *Ministry of Forest. BC. Extension Note 30*: 1-6.
- Nüsslein S. & Faisst G. (1998): *Waldentwicklung im Nationalpark Bayerischer Wald 1998: Totholzflächen und Waldverjüngung*. Bayerische Landesanstalt für Wald und Forstwirtschaft, Freising. 25 p.
- Oberdorfer E. (1993): *Süddeutsche Pflanzengesellschaften, Teil II: Sand- und Trockenrasen, Heide- und Borstgrasgesellschaften, alpine Magerrasen, Saum-Gesellschaften, Schlag- und Hochstauden-Fluren*, 3 edition. Gustav Fischer Verlag, Jena. 355 p.
- Oberholzer J. & Heim A. (1910): *Geologische Karte der Glarneralpen 1:50'000*. (Spezialkarte Nr. 50), Schweiz. Geol. Kommission, Kartographia AG, Winterthur.
- Osawa A. (1994): Seedling responses to forest canopy disturbance following a spruce budworm outbreak in Maine. *Can. J. For. Res.* **24**(4): 850-859.
- Ott E., Frehner M., Frey H.-U. & Lüscher P. (1997): *Gebirgsnadelwälder: Ein praxisorientierter Leitfaden für eine standortgerechte Waldbehandlung*. Verlag Paul Haupt, Bern, Stuttgart, Wien. 287 p.
- Parker K.W. & Savage R.W. (1944): Repeatability of the line interception method in measuring vegetation on the Southern Great Plains. *J. Am. Soc. Agron.* **36**: 97-110.
- Parminter J. & Daigle P. (1997): Landscape ecology and natural disturbances: Relationships to biodiversity. *Ministry of Forest, British Columbia, Extension Note 10* (part 2 of 7).
- Peterson C.J. & Carson W.P. (1996): Generalizing forest regeneration models: the dependence of propagule availability on disturbance history and stand size. *Can. J. For. Res.* **26**: 45-52.
- Raphael M.G. & Morrison M.L. (1987): Decay and dynamics of snags in the Sierra Nevada, California (USA). *For. Sci.* **33**(3): 774-783.
- Reif A. & Przybilla M. (1995): Zur Regeneration der Fichte (*Picea abies*) in den Hochlagen des Nationalparks Bayerischer Wald. *Hoppea* **56**: 467-514.
- Ricard J.-P. & Messier C. (1996): Abundance, growth and allometry of red raspberry (*Rubus idaeus* L.) along a natural light gradient in a northern hardwood forest. *For. Ecol. Manage.* **81**(1): 153-160.
- Roth I. (1996): Untersuchungen über die forstliche Ansammlung in einem abgestorbenen Fichtenbestand, Objekt: Gandberg oberhalb Schwanden GL. *Diplomarbeit*. Departement Wald- und Holzforschung, ETH, Zürich. 99 p.
- Rydgren K., Okland R.H. & Okland T. (1998): Population biology of the clonal moss *Hylocomium splendens* in Norwegian boreal spruce forests. 4. Effects of experimental fine-scale disturbance. *Oikos* **82**(1): 5-19.
- Sage R.W., Porter W.F. & Underwood H.B. (2003): Windows of opportunity: white-tailed deer and the dynamics of northern hardwood forests of the northeastern US. *J. Nat. Con.* **10**(4): 213-220.
- Schulz B. (1996): Response of residual spruce in beetle-impacted stands in Resurrection Creek Drainage, Kenai Peninsula, Alaska. *USDA For. Serv., Tech. Rep.* **62**: 1-21.

- Shorohova E.V. & Shorohova A.A. (2001): Coarse woody debris dynamics and stores in a boreal virgin spruce forest. *Ecol. Bull.* **49**: 129-135.
- Sims H.P. & Mueller-Dombois D. (1968): Effect of grass competition and depth to water table on height growth of coniferous tree seedlings. *Ecology* **49**(4): 597-603.
- Starfield A.M. & Chapin F.S. (1996): Model of transient changes in arctic an boreal vegetation in response to climate and land use change. *Ecol. Appl.* **6**(3): 842-864.
- Szewczyk J. & Szwargrzyk J. (1996): Tree regeneration on rotten wood and on soil in old-growth stand. *Vegetatio* **86**(122): 37-46.
- Tan B.S. & Bruckert S. (1992): Effect of physical environmental factors on the initial stages of the natural regeneration of fir (*Abies alba*) at some sites in the Jura. *Ann. Sci. For.* **49**(4): 337-349.
- Tarasov M.E. (1999): Role of coarse woody debris in carbon balance of forest ecosystems of Leningrad Oblast. *PhD-Thesis (in Russian)*. St. Petersburg Forestry Research Institute, St. Petersburg. 21 p.
- Tarasov M.E. & Birdsey R.A. (2001): Decay rate and potential storage of coarse woody debris in the Leningrad region. *Ecol. Bull.* **49**: 137-147.
- Ulanova N.G. (2000a): The effects of windthrow on forests at different spatial scales: a review. *For. Ecol. Manage.* **135**: 155-167.
- Ulanova N.G. (2000b): Plant age stages during succession in woodland clearings in Central Russia. *Proceedings IAVS Symposium*. I.A.V.S. Opulus Press Uppsala, Schweden. 80-83.
- Usher M.B. (1981): Modelling ecological succession, with particular reference to markovian models. *Vegetatio* **46**: 11-18.
- Vallin H. (1974): Vegetation changes in a moss cushion during 50 years. *Svensk Botanisk Tidskrift* **68**: 169-191.
- Van Hulst R. (1979): On the dynamics of vegetation: Markov chains as models of succession. *Vegetatio* **40**: 3-14.
- Vanclay J.K. (1994): *Modelling forest growth and yield: applications to mixed tropical forests*. CAB International, Wallingford.
- Waggoner P.E. & Stephens G.R. (1970): Transition probabilities for a forest. *Nature* **225**: 1160-1161.
- Walcher J. & Kupferschmid A.D. (2001): Borkenkäfer-Schadenflächen bei Schwanden. In: Thomas Rageth (ed.) *Binding Preis für vorbildliche Waldpflege 2001: Vivian als Chance*. Gemeinde Schwanden GL. Sophie und Karl Binding Stiftung, Basel. 43-45.
- Wermelinger B., Obrist M.K., Duelli P. & Forster B. (1999): Development of the bark beetle (Scolytidae) fauna in windthrow areas in Switzerland. *Mitt. Schweiz. Entomol. Ges.* **72**: 209-220.
- Whitney G.G. (1982): The productivity and carbohydrate economy of a developing stand of *Rubus idaeus*. *Can. J. Bot.* **60**: 2687-2703.
- Wohlgemuth T. & Kull P. (2002): Disturbance of microsites and early tree regeneration after the catastrophic windthrow Vivian 1990 in Swiss mountain forests. *For. Snow Landsc. Res.* **77**(1/2): 17-47.
- Wurz T.L. & Wahrenbrock W.W. (2000): Can mulch mats help regenerate beetle-killed spruce forests? *Agroborealis* **32**(2): 4-6.

- Yeager L.E. & Riordan L.E. (1953): Effects of beetle-killed timber on range and wildlife in Colorado. *Transitions of the eighteenth North American wildlife conference*, Washington. 596-616.
- Yli-Vakkuri P. (1961): Kokeellisia tutkimuksia taimien sytymisestä ja ensi kehityksestä kuusikoissa ja männiköissä (Experimental studies on the emergence and initial development of tree seedlings in spruce and pine stands). *Acta For. Fenn.* **75**: 1-122 (English summary 111-122).

8. Appendix: model parameterisation

8.1 Transition probabilities involving woody microsite types

Tree-Snag: After the lethal bark beetle infestation, trees lost their needles during the first year (i.e. defoliation), and the fine brushwood until the end of the second year. In the literature, a time lag of at least 2-3 years was reported for *Picea* until woody decomposition started, i.e. until mass loss occurred (e.g. Harmon *et al.* 1986, Shorohova and Shorohova 2001, Tarasov and Birdsey 2001). For our model, a time lag of 3 years was assumed, i.e. 99% of the dead trees were assumed to have lost their needles and fine brushwood after 3 years. Supposing a negative exponential decay curve, this results in a transition probability from the microsite type 'Tree' to 'Snag' of about 0.75 yr^{-1} (i.e. $1 - (\text{tree}_{t=3} / \text{tree}_o)^{1/t} = 1 - (1/100)^{1/3} \cong 0.75 \text{ yr}^{-1}$).

Snag-Stump: In the strip transects, about 25% of the trees were broken below 10 m above ground in the year 2000 and 50% of the trees were broken close to the tree top, or at least higher than 10 m (Kupferschmid Albisetti *et al.* 2003). Classifying only the former as 'broken' and the latter as '1/3 broken', 42% of the snags changed to stumps in the 4 years between the end of the time lag (see above) and the year 2000. The decay rate from the microsite type 'Snag' to 'Stump' was therefore calculated (again assuming a negative exponential curve) as a constant of 0.13 yr^{-1} . This is well within the range of decay rates collected by Harmon (1986).

Stump-CWD (Coarse Woody Debris), Log-CWD, Branch-CWD and Root-CWD: According to the literature, the decay rate of *Picea abies* logs is between 0.016 and 0.05 yr^{-1} (Shorohova and Shorohova 2001, Tarasov and Birdsey 2001). Smaller diameter classes tend to decay faster than larger ones (Tarasov 1999). As our conditions on the north-facing Gandberg are likely to be more humid than those in Russia, we estimated the decay rate for

the microsite type ‘Stumps’ and ‘Roots’ into ‘CWD’ to be 0.07 yr^{-1} , for ‘Logs’ 0.05 yr^{-1} , and for ‘Branches’ 0.08 yr^{-1} .

Snags-Timber and non-woody microsities-Logs: When snags become stumps, ‘Timber’ is produced with the same probability, but the ground area occupied by ‘Timber’ (= ‘hanging logs’) is larger than that occupied by a snag, which is a consequence of the length of the logs. As mentioned in the model initialisation section ‘woody microsite types’, the dbh of a typical *Picea abies* specimen from the Gandberg was 35 cm, its projected diameter at the soil surface (d_{base}) 50 cm and its height 28 m (Fig. 4). We assumed a point of breakage of 1 m above the forest floor (a snag may break several times before it finally breaks at this low height), resulting in a timber length (l_{timber}) of 27 m (Fig. 4) and a diameter at break point (d_{break}) of 0.4 cm (interpolated between the diameter at soil surface (0.5 cm) and the dbh (0.35 cm)). For the lying logs in the transects, we measured a diameter loss of 1 cm per 1 m of tree height (Kupferschmid Albisetti *et al.* 2003). Hence, according to Eq. (2) a log occupies an area (a) of approximately 7.15 m^2 .

$$a = l_{\text{timber}} * \frac{d_{\text{break}} + d_{\text{top}}}{2} \quad (2)$$

$$a = l_{\text{timber}} * \frac{d_{\text{break}} + (d_{\text{break}} - (l_{\text{timber}} * 0.1))}{2}$$

$$a = 27 * \frac{0.40 + (0.40 - (27 * 0.1))}{2} = 7.15 \text{ m}^2$$

Consequently, the area of the calculated state ‘Timber’ (7.15 m^2) that is created when the transition from a snag to a stump occurs, is about 36 time larger than that of ‘Snags’ (0.2 m^2), resulting in an area correction factor of 36 (Fig. 4). In the permanent plots, hanging logs (i.e., our state ‘Timber’) first occurred in winter 1996/97 (Kupferschmid 2002). In 2001, 25% of the logs lay directly on the ground, resulting in 6.5% areal cover of the microsite type ‘Logs’ (Fig. 1 (in contrast to Fig. 2, where timber, snags and stumps are merged, resulting in 12 and 19% total cover of woody microsite types on the montane and subalpine levels)). The transition probability from ‘Timber’ to ‘Logs’ was therefore calculated as 0.06 yr^{-1} .

The area newly covered by logs was assumed to reduce the cover of the microsite types ‘Roots’, ‘CWD’ and all non-woody microsite types (except for the microsite types ‘Picea’, ‘Sorbus’ and ‘Betula’) in proportion to their occurrence at a given time step.

Effects of branches on the frequency of non-woody microsite types: We assumed that both tree and snags lost branches, and that in the year 2001 about 50% of the branches had already fallen (Kupferschmid, pers. obs.). As with logs, it was not ‘Tree’ and ‘Snag’

microsite types that changed into the microsite type ‘Branches’, but other non-woody microsite types were covered by fallen branches, and obviously this area was larger than the area of tress and snags from which the branches originated. To take this into account, an area correction factor for the generation of branch microsities was estimated. Branches and fine brushwood were found to amount to about 8-13% of the merchantable timber mass (Dauber and Kreuzer 1979, Kramer and Krüger 1981) and about 10% of the total timber volume (Kaufmann 2001), respectively. With an average timber volume per tree of about 1 m³ (average dbh = 35 cm, and using the local timber tariff of Schwanden), this led to 0.5 m³ of branches for the 5 trees per 100 m². With an average diameter of the branches of about 5 cm, 10 m² would be covered by branches from 5 trees. However, we assumed that about 50% of the branches lay on top of other branches, thus resulting in a maximum of about 5 m² of the microsite type ‘Branches’ from these 5 trees. The 5 trees together covered 1 m², therefore the area correction factor for the surface area covered by branches was 5 (cf. Fig. 4). We assumed that branches were mostly found below the former tree crowns. The area newly covered by branches was therefore assumed to reduce the area of the microsite types ‘Bare Soil’ and ‘Oxalis’, and only to a lower extent ($\frac{1}{3}$) also the area of the microsite types ‘Polytrichum’, ‘Hylocomium’ and ‘Other Mosses’, always in proportion to their occurrence at a given time step.

CWD-Picea, CWD-Betula and CWD-Sorbus: *Picea* height growth is fairly slow on coarse woody debris (Eichrodt 1969, Newsome *et al.* 1995), and seed years are infrequent at this elevation (Mencuccini *et al.* 1995), so that new recruitment cannot occur every year. Furthermore, both *Betula* and *Sorbus* regeneration was even less frequent on the Gandberg than *Picea* regeneration (Kupferschmid 2001, Kupferschmid *et al.* 2002). We therefore assumed a very small transition probability into the microsite type ‘Picea’ (0.005 yr⁻¹) and an extremely small one into ‘Betula’ and ‘Sorbus’ (0.001 yr⁻¹).

Root-Picea, Root-Betula and Root-Sorbus: Only *Picea* was supposed to be sometimes successful in establishing on roots. The transition probability from ‘Root’ to ‘Picea’ was set to an extremely small value (0.001 yr⁻¹).

8.2 Transition probabilities of non-woody microsite types at the montane level

The general procedure to derive the transition probabilities has been described in the section ‘model parameterisation’. Below, the second and third steps of this procedure are explained in detail.

Second step: the self-replacement probabilities (p_{self}) were calculated for each microsite type using Eq. (3) (see e.g. Caswell 2001).

$$p_{self} = 1 - (1 / resTime) \quad (3)$$

where *resTime* is the residence time of a microsite type, that is the mean lifetime of this microsite type. As logs and branches normally fall onto non-woody microsites, the residence time of these non-woody microsite types were smaller than they would have been without the falling logs and branches, because they may change into the microsite types ‘Logs’ or ‘Branches’ due to this falling processes. The effective self-replacement probabilities (p_{self_eff}) in the matrix sub-model (which is here considered separately from the decay sub-model) are therefore the sum of the p_{self} calculated from the residence times (upper values in the grey boxes in Table 1) and the transitions into ‘Logs’ and ‘Branches’ (lower values in the grey boxes in Table 1). For each microsite type, both values are explained in detail below.

The area newly covered by logs was assumed to reduce the cover of the microsite types ‘Roots’, ‘CWD’ and all non-woody microsite types (except for the microsite types ‘Picea’, ‘Sorbus’ and ‘Betula’) in proportion to their occurrence at a given time step. The area newly covered by branches was assumed to reduce the area of the microsite types ‘Bare Soil’ and ‘Oxalis’, and to a lesser extent ($1/3$) also the area of the microsite types ‘Polytrichum’, ‘Hylocomium’ and ‘Other mosses’ (see above). These transitions are calculated in the decay sub-model and clearly vary over time. As in a standard matrix only constant parameters can be used, the transitions into the microsite types ‘Logs’ and ‘Branches’ were temporarily held constant during the estimation of all other transition probabilities. The transitions into the microsite type ‘Logs’ were set to 0.03 and into ‘Branches’ to 0.1 and 0.035, respectively (lower value in the grey boxes in Table 2).

The residence times (*resTime*) could often be estimated from the mean time a plant dominated or was frequent in the permanent plots (Fig. 5, Kupferschmid 2002). In this manner, the average residence time of the microsite type ‘Oxalis’ was estimated as 1.3 years, that of ‘Bare Soil’ as 1.5 years, ‘Polytrichum’ 2.2 years, ‘Hylocomium’ and ‘Other Mosses’ about 3 years.

Other residence times were assessed by calculating the approximate time required for another plant to invade a microsite type. For example, it was assumed that *Picea abies* seedlings needed at least 15-20 years to overtop *Rubus idaeus*, which was on average 150 cm high (Kupferschmid *et al.* 2002). This is a longer *Rubus* dominance than what was found in several other studies (e.g. Whitney 1982, Brown 1994, Ricard and Messier 1996, Ishizuka *et al.* 1998, Ulanova 2000b). However, after 8 years only a few *Betula* trees had overgrown *Rubus* in the permanent plots of the Gandberg forest (Fig. 1, microsite type ‘Betula’), and *Picea abies* trees were only about 20 cm high (13.6 ± 6.8 without including shoots of 2001, see Kupferschmid *et al.* 2002). Hence, *Picea abies* seedlings will need at least an additional 9 years to overtop *Rubus idaeus* on the montane level of the Gandberg. Therefore, the residence time of *Rubus idaeus* was assessed as 15 years (and then was split into the residence times of the microsite types ‘MossRubus’ and ‘Rubus’, see below). Similarly, the time *Picea abies* requires to overgrow a *Betula* or *Sorbus aucuparia* pioneer crop is about 20-40 years, assuming that seedling establishment took place at the same time (Hillebrand and Leder 1995). Thus, the residence times of the microsite types ‘Betula’ and ‘Sorbus’ were set to about 33 years ($p_{\text{self}} = 0.97$). *Sambucus racemosa* was assumed to be overtopped by *Picea abies* and *Sorbus aucuparia* more quickly than the pioneer trees, therefore the residence time of the microsite type ‘Sambucus’ was assessed to be about 20 years. Furthermore, the residence time of ferns (mostly *Dryopteris dilatata*, *D. filix-mas*, *Athyrium filix-femina* and *Gymnocarpium dryopteris*) was assumed to be only 10 years, because *Rubus idaeus* was able to spread vegetatively into some fern patches within the past decade. We assumed that mosses overgrow boulders quite slowly (Vallin 1974, Rydgren *et al.* 1998), so that the residence time of ‘Boulder’ was estimated with 20 and the one of ‘MossBoulder’ with about 25 years. ‘Other Vegetation’ (i.e. mostly *Senecio*) was assumed to persist for 20 years.

Third step: the following set of additional assumptions was used to estimate transition probabilities between the different microsite types (cf. Table 2):

- In a transition matrix, the column total must always equal 1, therefore the sum of all the transition probabilities from one specific microsite type into all *other* microsite types (p_{other}) is constrained by

$$p_{\text{other}} = \sum p_{ij} = 1 - p_{\text{self_eff}} \quad (4)$$

where p_{ij} denotes the transition between all non-woody microsite types (i and j) (cf. Table 2).

- Succession is assumed to be forward and not backward directed. For example, ‘Bare Soil’ cannot arise out of ‘Rubus’, ‘Fern’ or the other microsite types into which it

- changed in early succession; similarly, the mosses lost underneath *Rubus idaeus* cannot regrow.
- Large values of transition probabilities were estimated to an accuracy of 1%; very small transition probabilities were assumed to be 0.005 yr^{-1} , and extremely small transition probabilities were assumed to amount to 0.001 yr^{-1} .
 - *Oxalis acetosella* was the first species which benefited from the tree defoliation and increased its cover in the first years (Fig. 5, Kupferschmid 2002). Therefore, 'Bare Soil' was assumed to change mostly to 'Oxalis' with a probability of 0.5 yr^{-1} (Table 2).
 - The second species which increased dramatically was the moss *Polytrichum formosum* (Fig. 5, Kupferschmid 2002). At that time, the amount of Oxalis already began to diminish. Hence, the microsite type 'Oxalis' changed mostly into the microsite type 'Polytrichum' (we assumed a probability of 0.42 yr^{-1}), but also in 'Hylocomium' (0.06 yr^{-1}), and 'Other mosses' (0.02 yr^{-1} , Table 2).
 - Mosses cannot emerge below *Rubus idaeus* or ferns, therefore the microsite types 'MossRubus' and 'MossFern' must originate from the microsite types 'Polytrichum', 'Hylocomium' or 'Other mosses' (= 'Moss'), and not directly from the microsite types 'Bare Soil' or 'Oxalis' (Table 2). The substitution of all moss microsite types by *Rubus* and ferns was assumed to be about $\frac{1}{3}$ of the cover per year. In the permanent plots, the microsite type 'FernRubus' was almost twice as frequent as 'MossRubus', and 'MossRubus' in turn was more than twice as frequent as the microsite type 'MossFern' in 2001 (Fig. 1). Hence, the transition probabilities from 'Polytrichum' and 'Hylocomium' into 'FernRubus' were estimated both as to be 0.2 yr^{-1} , while the transition probabilities into 'MossRubus' were assumed to be 0.12 yr^{-1} and 0.08 yr^{-1} , and those into 'MossFern' 0.06 yr^{-1} and 0.05 yr^{-1} , respectively (Table 2).
 - At the montane level, 'Other mosses' represented mostly liverworts, which were often found in small depressions. Ferns were assumed to be about 40% more efficient in colonising these sites than *Rubus*. Transition probabilities were therefore 0.15 yr^{-1} into 'MossFern', 0.09 yr^{-1} into 'FernRubus', and 0.08 yr^{-1} into 'MossRubus' (Table 2).
 - In the permanent plots, *Rubus* and ferns emerged at the same time and with about an equally low frequency (Fig.5, Kupferschmid 2002). Therefore, we assumed a transition probability from 'Oxalis' into 'Fern' and 'Rubus' of 0.02 yr^{-1} , and into 'FernRubus' of 0.07 yr^{-1} (Table 2).
 - Mosses were prone to slow but considerable mortality when growing underneath *Rubus* or ferns. The residence times of the microsite types 'MossRubus' and

‘MossFern’ were therefore assumed to be only 10 years, and 6% of the ‘MossRubus’ cover was assumed to change into ‘Rubus’ and 5% of ‘MossFern’ into ‘Fern’ per year (Table 2).

- Underneath *Rubus idaeus* (microsite type ‘Rubus’), no ferns can emerge, but *Rubus* can germinate under ferns, or it can spread vegetatively into the microsite types ‘Fern’ or ‘MossFern’. Consequently, the transition probability from the microsite type ‘Fern’ into ‘FernRubus’ was estimated as 0.07 yr^{-1} , and from ‘MossFern’ into ‘FernRubus’ as 0.02 yr^{-1} (Table 2).
- Furthermore, fern in the microsite type ‘FernRubus’ partly died due to shading by the much taller *Rubus idaeus*, resulting in a 5% and 2% loss of ‘FernRubus’ into ‘Rubus’ and ‘MossRubus’ per year, respectively (Table 2). The residence time of ‘FernRubus’ was also estimated to be 10 years.
- Due to competition with pioneer species or spruce, small amounts of ‘Rubus’ and ‘MossRubus’ changed into ‘Picea’, ‘Sorbus’ or ‘Betula’. As mentioned above, *Picea abies* is expected to replace *Rubus idaeus* with time (Oberdorfer 1993), as suggested by the fact that *Picea abies* is able to survive under *Rubus* (Mayer 1960, Cavegn 1996, Wohlgemuth and Kull 2002). Tree growth is therefore crucial and will be modelled explicitly in a separate model (not described here). Here, it was assumed that *Picea abies* seedlings need at least 15 years to overtop *Rubus idaeus* on the montane elevational level of the Gandberg (see earlier in this section). Taking further into account that the microsite type ‘Rubus’ can originate not only from ‘MossRubus’ and ‘FernRubus’ (see above), but also from ‘Oxalis’ (cf. Table 2), the mean residence time in the microsite type ‘Rubus’ was set to 8 years (while amounting to 10 years in ‘MossRubus’ and ‘FernRubus’). With these 8 years (together with the 10 years in ‘MossRubus’ and ‘FernRubus’), the estimated average dominance of *Rubus idaeus* of 15 years could be maintained. Then, the transition probabilities into the microsite type ‘Picea’ were directly derived from the fact that the column total of the matrix must be 1. Thus ‘Rubus’ was assumed to change into ‘Picea’ at a rate of 0.09 yr^{-1} and ‘MossRubus’ into ‘Picea’ at a rate of 0.01 yr^{-1} .
- Large patches of the microsite type ‘Other vegetation’ (mostly composed of *Senecio ovatus*, formerly known as *Senecio fuchsii*) can be understood as a *Senecionetum fuchsii* association, which is normally replaced by a *Sambucetum racemosae* association (Oberdorfer 1993). *Rubus* and fern abundance are not changing much in the *Senecionetum fuchsii* (Oberdorfer 1993), and our patches of *Senecio ovatus* were rather small. Therefore, we assumed small transition probabilities from ‘Other Vegetation’ into the microsite types ‘Fern’ (0.01 yr^{-1}), ‘Rubus’ (0.005 yr^{-1}) and ‘Sambucus’ (0.005 yr^{-1}).

- *Picea abies* regeneration is performing poorly underneath ferns (Reif and Przybilla 1995, Cavegn 1996, Holeksa 1998), *Senecio ovatus* (Tan and Bruckert 1992) and grasses such as *Calamagrostis villosa* (Lieffers *et al.* 1993, Reif and Przybilla 1995, Cavegn 1996). However the microsite types ‘MossBoulder’, ‘Polytrichum’ and ‘Sambucus’ were presumed not to impede the growth of *Picea* regeneration (Heurich 2001), likewise ‘Bare Soil’ (Brang 1998). As *Picea abies* seedlings grew slowly on the Gandberg (Kupferschmid *et al.* 2002), it was assumed that moss, grasses, herbs and shrubs had invaded the microsite ‘Bare Soil’ before larger *Picea* saplings were established. The other transition probabilities from the microsite types ‘MossBoulder’, ‘Polytrichum’ and ‘Sambucus’ into ‘Picea’ were also extremely small, due to the slow tree growth (except for ‘Rubus’ and ‘MossRubus’, as mentioned above).
- In the permanent plots, *Picea abies* was found by far more often than *Betula pendula* or *Sorbus aucuparia* (Kupferschmid *et al.* 2002). Therefore, the transition probabilities into the microsite types ‘Betula’ or ‘Sorbus’ were assumed not to exceed those of the microsite type ‘Picea’. However, in contrast to *Picea*, *Betula* spp. can probably grow up underneath grasses (Ishizuka *et al.* 1998, Ulanova 2000b) and likewise does *Sorbus aucuparia* (Heurich 2001). Therefore, the transition probabilities from ‘Grasses’ into the microsite types ‘Betula’ and ‘Sorbus’ were set to be very small (0.005 yr^{-1}).
- *Acer pseudoplatanus* and *Abies alba* were browsed so heavily in this region, which is part of the wildlife sanctuary ‘Freiberg Kärpf’, that no taller saplings of the two species were found (Kupferschmid *et al.* 2002), and hence neither microsite type was included in the model.

8.3 Transition probabilities of non-woody microsite types at the subalpine level

A procedure similar to the one for the montane level was used to estimate transition probabilities for the subalpine level (Table 3). However, some assumptions were different:

- The residence times of some microsite types were assumed to differ from the montane level because ferns, *Rubus* and grasses were found to behave differently. Succession was slower (Fig. 2), and therefore almost all self-replacement probabilities were assumed to be larger, except for ‘MossBoulder’ and ‘Sambucus’ where they were assumed to be identical to the montane level. Another exception was the microsite type ‘Vegetation’ with a shorter residence time, because the microsite type ‘Vegetation’ was mostly composed of *Senecio* at the montane level (resTime =

- 20 years), but mostly of *Vaccinium* (resTime = 10 years) apart from *Stellaria nemorum* (resTime = 2 years) at the subalpine level (together subalpine resTime = 8 years, Table 3).
- *Oxalis acetosella* was found only rarely in the living stands of the subalpine level of the Gandberg compared to the montane level (Fig. 1). Consequently, *Oxalis* was assumed not to increase after the *Picea* die-back. Unlike at the montane level, the microsite type 'Bare Soil' hence did not change into 'Oxalis' in the subalpine model (Table 3). Furthermore, apart from 'Oxalis' (0.02 yr^{-1}) also 'Bare Soil' could therefore change directly into 'Fern' (0.035 yr^{-1} , Table 3).
 - In the living subalpine stands, mosses were almost exclusively found on boulders, whereas after tree die-back mosses spread mainly under the former tree crowns. Therefore, the microsite types 'Bare Soil' changed directly into 'Polytrichum' in the subalpine model, with a transition probability of 0.2 yr^{-1} (Table 3).
 - At the subalpine level, 'Other mosses' included mostly *Sphagnum* and not liverworts as on the montane level. *Calamagrostis villosa* was assumed to be the only species which was efficient in colonising this *Sphagnum*-dominated microsite type. Hence, 'Other mosses' changed into 'Grasses' with a transition probability of 0.035 yr^{-1} (Table 3).
 - The microsite type 'Grass' was mostly composed of *Calamagrostis villosa* and sedges. The transect survey at the subalpine level in the year 2000 did not indicate that *Calamagrostis villosa* had expanded after tree death (Fig. 2). In contrast, *Calamagrostis* cover decreased, which agreed with the findings of Märkl and Eglseer (2001) in a snag stand in Germany. However, on the Gandberg there was only a weak indication that probably *Anthoxanthum alpinum* caused this reduction of *Calamagrostis*. (Wohlgemuth and Kull 2002) observed in clear-cuttings that *Rubus idaeus* overgrew the *Calamagrostis* tussocks. However, in the year 2000 at the subalpine level of the Gandberg, *Rubus* was still very sparse and was found mostly under the former tree crowns. As *Calamagrostis* was found in rather open places, the observed decline may not be due to *Rubus* but was perhaps an artefact of transect positioning. We therefore surmise that the frequency of the microsite 'Grasses' diminished only due to covering by logs. Similar to the simulation on the montane level, we assumed that grasses grew very slowly (0.005 yr^{-1}) into the microsite types 'Bare Soil', 'Oxalis' and 'Polytrichum', and extremely slowly (0.001 yr^{-1}) into 'Hylocomium' and 'MossRubus' (Table 3).
 - *Rubus idaeus* was less abundant at the subalpine than at the montane level (Fig. 2). Thus, 'Polytrichum' and 'Hylocomium' mostly changed into 'MossFern' (0.07 yr^{-1}

and 0.06 yr^{-1}), and only extremely rarely into 'MossRubus' or 'FernRubus' (0.001 yr^{-1} , Table 3).

- *Rubus idaeus* was less tall at the subalpine level in comparison to the montane level, so that ferns were able to grow into the microsite types 'Rubus' and 'MossRubus'. Therefore, few or extremely few of these microsite types were assumed to change to 'FernRubus' (Table 3).
- Besides the microsite types 'MossBoulder', 'Polytrichum' and 'Sambucus', the microsites types 'Bare Soil' and 'Other Vegetation' were also assumed to be favourable for *Picea* regeneration on the subalpine level, in contrast to the montane level. Furthermore, as the succession was different on the subalpine level compared with the montane level, 'MossRubus' and 'Rubus' were assumed to rather inhibit *Picea* regeneration at the subalpine level.
- At the subalpine level, no reproductive trees of *Abies alba* and *Betula pendula* were present, and almost no *Acer pseudoplatanus*. Larger saplings of these trees were therefore not expected. We hence did not include these microsite types in our model of the subalpine level.

IV C Tree regeneration model ‘RegSnag’

Reprint of the submitted article:

Kupferschmid A. D., Brang P., Schönenberger W. and H. Bugmann (submitted):
Predicting tree regeneration in *Picea abies* snag stands. *Forest Science*.

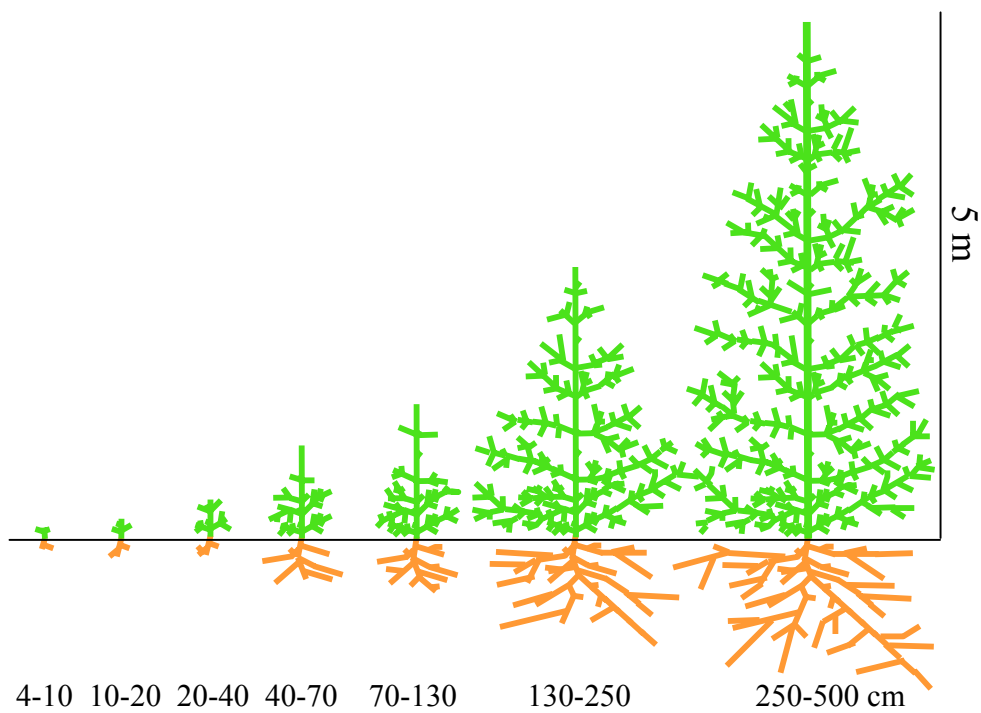

Sketch of the height classes in the model ‘RegSnag’

Predicting tree regeneration in *Picea abies* snag stands

Andrea D. Kupferschmid, P. Brang, W. Schönenberger and H. Bugmann

Abstract:

A bark beetle (*Ips typographus* L.) infestation caused the death of almost all Norway spruce (*Picea abies* (L.) Karst.) trees in a mountain forest in the Swiss Alps. We developed the new tree regeneration model 'RegSnag' (Regeneration in a Snag stand) to project the future amount and height of tree regeneration in these snag stands. The model combines a height-class structured module with a microsite-based module of snag-decay and ground-vegetation succession. Microsite-specific rates of germination, mortality and height growth were modelled for 4 tree species (*Picea abies*, *Sorbus aucuparia* L., *Acer pseudoplatanus* L. and *Betula pendula* Roth.) in 8 height classes (from seedlings to 5 m tall saplings) and on 26 microsite types (e.g. moss on boulders, coarse woody debris).

Simulation runs showed that on both montane and subalpine elevational levels microsites had a strong effect on the development of tree regeneration. With microsite-specific parameters, the height and frequency of *Picea* in each microsite could be simulated more accurately than without considering microsite effects, as a test with independent field data from 8 years after *Picea* die-back demonstrated. Results of long-term simulations suggest that ca. 330-930 *Picea* saplings per ha out of those that germinated in 1994 and 1996 will reach the height of 5 m about 30-35 years after *Picea* die-back. This is due to differences in the browsing intensities and seed inflow into the montane and subalpine level of the Gandberg. *Picea* and not *Betula* or *Sorbus* trees will therefore replace the current vegetation in these snag stands.

Keywords

seedbed, microsites, size class model, forest succession, height increment

Nomenclature

Lauber und Wagner (1996) was used for ground vegetation and tree species, and Ott *et al.* (1997) for forest associations.

1. Introduction

Disturbances such as windthrows and beetle infestations drive forest ecosystem dynamics over a wide range of spatial scales. When such disturbances strike stands that provide protection against natural hazards (i.e. protection forests, see Brang *et al.* 2001), a rapid restoration of the tree cover in the destroyed stands is needed if their protective effect against snow avalanches and rock fall is to be maintained (Chauvin *et al.* 1994, Mössmer 1998, Schönenberger 2000). In particular, regenerating trees should provide protection before the snags, stumps and logs of the destroyed stand lose their protective effect, so that the stand provides effective protection at all times (cf. Kupferschmid Albisetti *et al.* 2003).

However, little is known about the development of natural tree regeneration in beetle-killed stands. In interior Alaska, a spruce bark beetle (*Dendroctonus rufipennis* Kirby) outbreak caused a forest conversion from *Picea glauca* into *Betula* stands because spruce regeneration was sparse (Baker and Kemperman 1974). The same happened in the Rocky Mountains where spruce-dominated snag stands with more than 10% fir in the overstory had changed into fir forests, and only stands with less than 10% fir remained spruce forests (Schmid and Frye 1977).

In snag stands in the Swiss Alps and Bavaria, it was also found that only small amounts of Norway spruce (*Picea abies* (L.) Karst.) and other tree species established during the first years after *Picea abies* die-back (e.g. Heurich 2001, Kupferschmid *et al.* 2002). Furthermore, *Picea abies* regeneration proceeds generally slowly in mountain forests (e.g. Lüscher 1990, Frehner 2000). It would therefore be risky to adopt a 'wait and see' strategy after a beetle infestation in snag stands that should provide effective protection against natural hazards. Instead, mathematical modelling of snag stands can be used to analyse and predict tree regeneration processes. The development of such a tree regeneration model and its application to a case study was at the core of this research. Our further applied objectives were to (i) project the amount and height distribution of tree regeneration in snag stands into the future, and (ii) to predict their future tree species composition.

As a case study, the snag stands in the Gandberg forest in the Swiss Pre-Alps were chosen, mainly because a considerable amount of data were available on the short-term succession (first 8 years), in particular about the decay process (Kupferschmid Albisetti *et al.* 2003), ground-vegetation development (Kupferschmid 2002) and tree regeneration (Kupferschmid *et al.* 2002). Furthermore, medium-term development of the snag decay and vegetation succession have already been modelled successfully for the montane and subalpine snag stands of the Gandberg forest (Kupferschmid and Bugmann submitted). To cut it short, a dramatic change in vegetation, with an intensive raspberry invasion, was

found during the first years after *Picea* die-back in the montane snag stands, while in the subalpine snag stands grasses, ferns and mosses dominated these first years.

Particularly in the subalpine zone, a crucial issue in the regeneration process of trees is the availability of suitable microsites. In the case of *Picea abies*, such sites are for example rotten wood, rocks or other elevated sites, which provide sufficient direct sunlight, absence of competing ground-vegetation and an early snowmelt (for a discussion see Brang 1997). The availability of such microsites clearly varies during the decay of snag stands, mainly because of changes in ground vegetation (as described above) and the increase in coarse woody debris. However, there is no simulation model which takes into account both, the strong dependency of tree establishment and growth on the microsite types, and this continual change in microsite availability (cf. chapter IV A "review of tree regeneration models" in Kupferschmid Albisetti in prep.).

As we are mostly interested in the amount and height of trees and we have already developed and tested a microsite-based decay and ground-vegetation model (Kupferschmid and Bugmann submitted), it was obvious to combine a model with tree regeneration structured in height classes with this microsite model. Germination, growth, mortality and browsing can thereby be implemented with different characteristics in each microsite type. For example, tree saplings on moss cushions can be modelled to grow faster than saplings on coarse woody debris, even though light availability would be the same.

The present paper is centred on the development of this new model 'RegSnag' (Regeneration in a Snag stand). It is then used to project the amount and height of tree regeneration in the snag stands on the Gandberg into the future. First, simulations were performed over the first 8 years after *Picea* die-back, and the results were compared with independent field data. Second, long-term simulations were performed.

2. Study site

The study site is located on the north face of the Gandstock, south of Schwanden (canton of Glarus, Switzerland) at an elevation of 1100-1600 m a.s.l. The Gandberg inclines towards the North at an angle of about 14-36° (30-80%), and the lower parts do not receive direct sunshine between October and April as a result of orographic shading. The soil is an acid brown soil with a tendency to podsol (Roth 1996). Its depth varies greatly due to the presence of Verrucano boulders deposited by rockfall, mainly at the montane level. The estimated mean annual precipitation for the Gandberg forest is 1600-2000 mm and the mean annual temperature 2-3°C (Kupferschmid Albisetti in prep.).

Before the *Picea abies* die-back, the entire Gandberg forest was dominated by Norway spruce (*Picea abies* (L.) Karst.). Only a few silver fir (*Abies alba* Mill., 1%) and

sycamore maple (*Acer pseudoplatanus* L., 3%) trees were present. The stands belong to the *Galio-Abieti-Piceetum* association at the montane level (1200-1450 m a.s.l.) and to the *Homogyno-Piceetum vaccinietosum myrtilli* at the subalpine level (1450-1600 m a.s.l.). In 1990, the forest had a growing stock of about 820 m³ha⁻¹ at the montane level and 590 m³ha⁻¹ at the subalpine level (Kupferschmid Albisetti *et al.* 2003).

Between 1992 and 1997, a large outbreak of the European spruce bark-beetle (*Ips typographus* L.) caused the death of almost all *Picea abies* trees on an area of approximately 100 ha, with a peak in 1993 when about 20 ha of *Picea abies*-dominated stands died in the Gandberg forest alone (Walcher and Kupferschmid 2001). Only about 2% of the *Picea*, but all *Abies alba* and *Acer pseudoplatanus* trees survived, scattered throughout the snag stands.

3. Description of the model RegSnag

3.1 Model structure

The model is composed of two modules: (i) a module that calculates the changes between microsite types, and (ii) a module that simulates the development of tree regeneration.

3.1.1 Microsite type module

The model of decay processes and ground-vegetation succession developed by Kupferschmid and Bugmann (submitted) was used to describe the changes between microsite types (defined in the chapter VII A of Kupferschmid Albisetti in prep.). Basically this model is composed of frequencies of 7 woody microsite types ('Tree', 'Snag', 'Stump', 'Log', 'Branch', 'Coarse Woody Debris' and 'Root') and 17 non-woody microsite types (e.g. 'Polytrichum', 'Rubus idaeus', 'Fern', 'Boulder', etc.). The core of the model is a matrix that contains all possible transition probabilities between the 17 non-woody microsite types (Kupferschmid and Bugmann submitted). The amount of logs, branches and coarse woody debris is calculated with the help of decay rates of snags. The model was parameterised separately for the montane and the subalpine levels of the Gandberg. Decay rates of snags and transition probabilities were estimated from field studies (Kupferschmid 2002, Kupferschmid *et al.* 2002, Kupferschmid Albisetti *et al.* 2003), and additional assumptions were derived from literature data (see Kupferschmid and Bugmann submitted).

Due to the explicit modelling of tree regeneration in the present study, we separated the microsite type 'Betula/Sorbus' of the original model into the microsite types 'Betula' and 'Sorbus', and added a new microsite type 'Acer', which resulted in 26 microsite types

in total (for a more detailed definition see chapter VII A of Kupferschmid Albisetti in prep.). Furthermore, we newly simulate the transition probabilities from all microsite types into the microsite types dominated by trees (i.e. ‘Betula’, ‘Sorbus’, ‘Acer’ and ‘Picea’) as a function of the amount of 1.3 m tall trees on the microsite types (see below). Otherwise, the microsite module is used here with the same parameters as in the original model (see Kupferschmid and Bugmann submitted).

3.1.2 Tree regeneration module

Tree regeneration is divided into height classes, i.e. class 1: 4-10 cm, 2: 10.1–20 cm, 3: 20.1-40 cm, 4: 40.1-70 cm, 5: 70.1 –130 cm, 6: 130.1-250 cm, 7: 250.1-500 cm and 8: > 500 cm. 500 cm was chosen as the upper class limit because we assumed that trees are part of the ‘protective regeneration’ (Ott *et al.* 1997) when they are taller than twice the maximum snow depth of a site, which is about 2.5 m on the Gandberg. For the main tree species in the snag stands on the Gandberg, separate classes were modelled (i.e. *Picea abies*, *Betula pendula*, *Sorbus aucuparia* and *Acer pseudoplatanus*).

For each height class, the amount and average height of the tree regeneration are simulated over time. The amount of seeds depends on the inflow of viable seeds during seed years. Ingrowth into the first height class is a function of the amount of seeds, the species-specific germination rate and the mortality rate until the first summer (m_0 , note that field observations were only made in July/August). Therefore, the minimum seedling height in the first height class was set to 4 cm, not to zero cm.

Tree regeneration in each height class is characterised by constant class-specific rates of growth, mortality and browsing. With these rates, the average height and number of trees in each class are calculated in each time step. Trees change height class with a class-dependent probability. The transition probability was assumed to be higher when the trees reach a size near the upper border of their size class. Therefore, these transition probabilities are not constant as in a matrix model, but are calculated in each time step according to the average height of the trees in each class. We use equation 1 to determine the transition probabilities (p), which is similar to the approach used by Bugmann *et al.* (1989) for calculating hatching probabilities of zooplankton.

$$p = \left(\frac{h_{mean} - h_{min}}{h_{max} - h_{min}} \right)^x \quad (1)$$

where h_{mean} = average height of the trees in a given class, h_{min} = minimum height of the class, and h_{max} = maximum height of the class. The parameter x is used to define the shape of the curve. Some trees grow faster than the average trees and would therefore change size

class earlier than average trees. Their small number is probably adequately simulated by choosing $x = 20$ in this probability equation.

Tree regeneration up to height class 5 (≤ 130 cm) is modelled separately for each microsite type. Consequently, saplings are stratified by microsite types within each height class. However, we assumed that boulders and all woody microsite types, except 'CWD' and 'Root', are unfavourable microsites for tree regeneration, and therefore no trees establish there. For all other microsite types, microsite-specific rates of germination, growth and mortality are used. Tree regeneration in the height classes 6-8 was assumed to be at least as tall as the ground vegetation and thus to grow independently of the microsite types they inhabited before (Fig. 1).

Generally speaking, tree regeneration is modelled with a size class approach with continuous growth functions within each combination of species, microsite type and height class.

3.1.3 Module coupling: tree regeneration in microsites

When a microsite type changes into another microsite type, the seedlings and saplings on this microsite types change their microsite type accordingly. When a microsite type changes with a certain transition probability, it can be assumed that the seedlings and saplings on it will be on the new microsite type with the same probability. Therefore, the transition probabilities in the microsite-based module can be used in the tree regeneration module to calculate the numbers of trees that change from one microsite type into another one, as induced by the change in microsite types (Fig. 1).

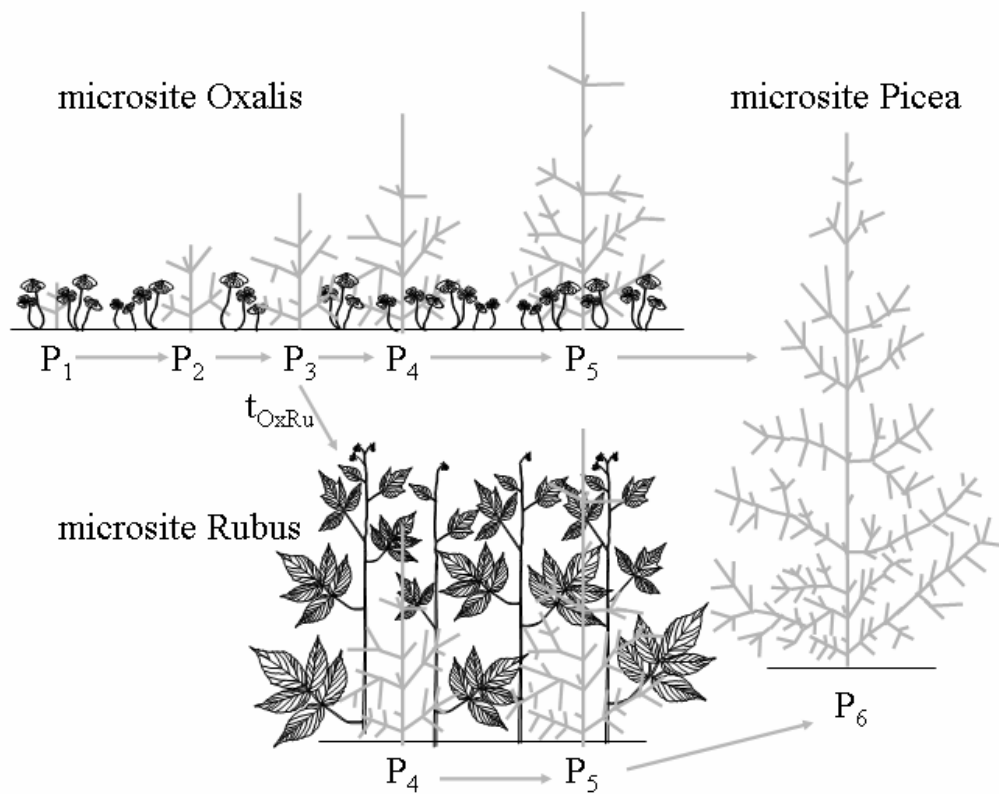

Fig. 1: Schematic diagram of the model 'RegSnag': As an example, only 3 microsite types and 3 transitions are shown. t_{OxRu} = transition probability from the microsite type 'Oxalis' into the microsite type 'Rubus' in the microsite module; $P_1 - P_6$ denotes the height classes of *Picea abies* in the tree regeneration module.

When tree saplings reach the height of 1.3 m - and hence have overgrown *Rubus idaeus* - the microsite type they currently inhabit is defined to change into the tree microsite types 'Betula', 'Sorbus', 'Acer' or 'Picea'. To calculate the proportion of area which changes into a tree microsite type during such a transition, it was assumed that a tree taller than 1.3 m covers an area of 0.5 m² (calculated based on crown diameters extrapolated from Hasenauer *et al.* 1994). In the case when *Betula pendula* trees reach the height of 1.3 m in the microsite types 'Sorbus' or 'Acer', only half of this area was assumed to change into 'Betula'. The same was assumed to happen in the opposite cases. When *Picea* trees reach the height of 1.3 m in the microsite types 'Betula', 'Sorbus' or 'Acer', it was assumed that only $\frac{3}{4}$ of this area change to 'Picea'. The other way round, we assumed a co-dominance and therefore supposed that only $\frac{1}{4}$ change from 'Picea' into 'Sorbus', 'Betula'

or ‘Acer’. When a tree in one of these tree microsite types die, the area it occupies was assumed to change into the microsite type ‘Bare Soil’.

3.1.4 Model implementation

The model simulates an area of 100 m², and it was initialised with the conditions inferred for the Norway spruce stands in 1993 (cf. section model initialisation). At that time, *Picea trees* had already been attacked by bark beetles, but they still carried their needles, and therefore the ground vegetation was still similar to that in a living stand (e.g. Kupferschmid 2002).

The model was constructed for simulating annual changes; however, due to the probable sensitivities of the height-class structured tree regeneration module to the annual growth increments, the model was implemented to run on a weekly time step. Generally, decay rates, transition probabilities, height increments, mortality rates and browsing intensities were derived on an annual basis (p_{annual}), and were transformed into weekly parameters (p_{week}) for the simulation model. Equation (2) was used to this end.

$$p_{\text{week}} = 1 - (1 - p_{\text{annual}})^{1/52} \quad (2)$$

Exceptions are the height increments and terminal shoot reduction due to browsing, which were simply divided by 52.

For model simplicity, seeds were assumed to be dispersed in week 51 of each year. One time step later, i.e. in week 52, the seed number was multiplied with the microsite-specific rates of germination and (1-seedling mortality m_0), resulting in the number of newly established trees at the end of each simulated year. This enabled us to compare the simulation results after 8 years (= 416 weeks) with independent field data, which were recorded in June 2001 including the seedlings of spring 2001. Consequently, it was not necessary to assign weekly rates to the tree germination (g) and seedling mortality (m_0) parameters.

The model was implemented with the STELLA® software (High Performance Systems 2001), using Euler’s integration method with a time step of one week (discrete time model). Due to the random processes, we always performed 10 simulation runs (i.e. to be able to replicate the stream of random numbers in processes with a random component, we determined the ‘seed’ in the STELLA® functions between 1 and 10).

3.2 Model initialisation

The model was initialised separately for the montane and subalpine levels because the ground vegetation on these two levels differs (cf. section study site or Kupferschmid and Bugmann submitted). The microsite module was used with the same initial values as in the original decay and vegetation development model (see Kupferschmid and Bugmann submitted). The initial amount of advance tree regeneration was assumed to be zero for all species and height classes because no seedlings and saplings were found in or around the permanent plots that were established in spring 1994 on the montane level of the Gandberg forest (Kupferschmid *et al.* 2002).

3.3 Model parameterisation

The model was parameterised separately for the two elevational levels, as tree regeneration grows more slowly on the subalpine than on the montane level. In this study, we assume a reduction of the height increment from the montane to the subalpine level of 10% (cf. Lüscher 1990, Frehner 2000), but we assumed that germination and mortality rates are identical on these two levels.

3.3.1 Seed rain, germination and mortality

No detailed information was available on the amount of inflowing seeds or on the ability of seeds to germinate in the snag stands on the Gandberg. However, vegetation succession and tree regeneration have been investigated in a pilot study on 24 permanent plots since 1994. These plots were established at the lower-montane level of the Gandberg where *Picea abies* trees had died in 1993. Each plot measured 1 m x 1 m. The position and number of establishing tree seedlings and saplings was recorded annually in July/August on a grid map. Germinants of 6 tree species were found during the first 8 years after *Picea* die-back in these permanent plots (Fig. 2, Kupferschmid *et al.* 2002).

In the model, the numbers of these germinants were the result of seed rain, germination rates and survival rates of seedlings from the time of germination until July/August. Therefore, we derived the annual numbers of seeds in the model by dividing the number of germinants in the permanent plots (cf. Fig. 2) by an average germination (g) and seedling survival rate ($= 1 - \text{average seedling mortality rate} = 1 - m_0$; equation 3).

$$\text{seed amount} = \frac{\text{germinants}}{g * (1 - m_0)} \quad [\text{N/m}^2] \quad (3)$$

For example, we assumed for *Picea abies* an average germination rate (g) of about 30% (cf. Brang 1996a, Holeksa 1998) and an average annual seedling mortality rate of about 25% (cf. Kupferschmid *et al.* 2002). For the observed number of germinants in the permanent plots (Fig. 2), this resulted in 0 up to about 14 seeds $m^{-2}yr^{-1}$ (= 140'000 seeds $ha^{-1}yr^{-1}$) during the first 8 years after *Picea* die-back. Details about the amounts of seeds, germination rates and mortality rates are explained for each tree species and microsite type in the Appendix, and the results are shown in Table 1-4 (see below).

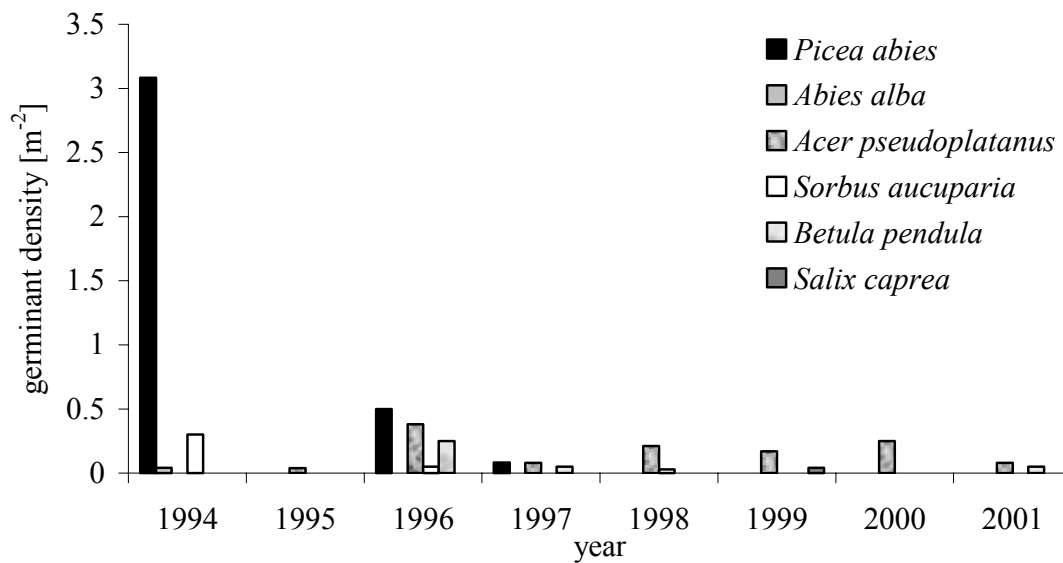

Fig. 2: Number of germinants that survived until July/August when the annual field controls were carried out in the 24 permanent plots on the montane level of the Gandberg forest.

3.3.2 Height increment

Height increments were estimated based on data derived from randomly sampled *Picea abies* saplings at the subalpine and montane level of the Gandberg forest.

We measured 113 *Picea* saplings that were randomly selected beneath the strip transects (see validation data set in section 4) in 2001 on the subalpine level. The height increment in the year 2000 was related linearly to the height of these randomly sampled unbrowsed *Picea* saplings (height without terminal shoot of the year 2000, cf. equation 4 and Fig. 3).

$$\text{average height increment } r_p = 0.438 * \text{height [cm]}, R^2 = 0.44, p < 0.001 \quad (4)$$

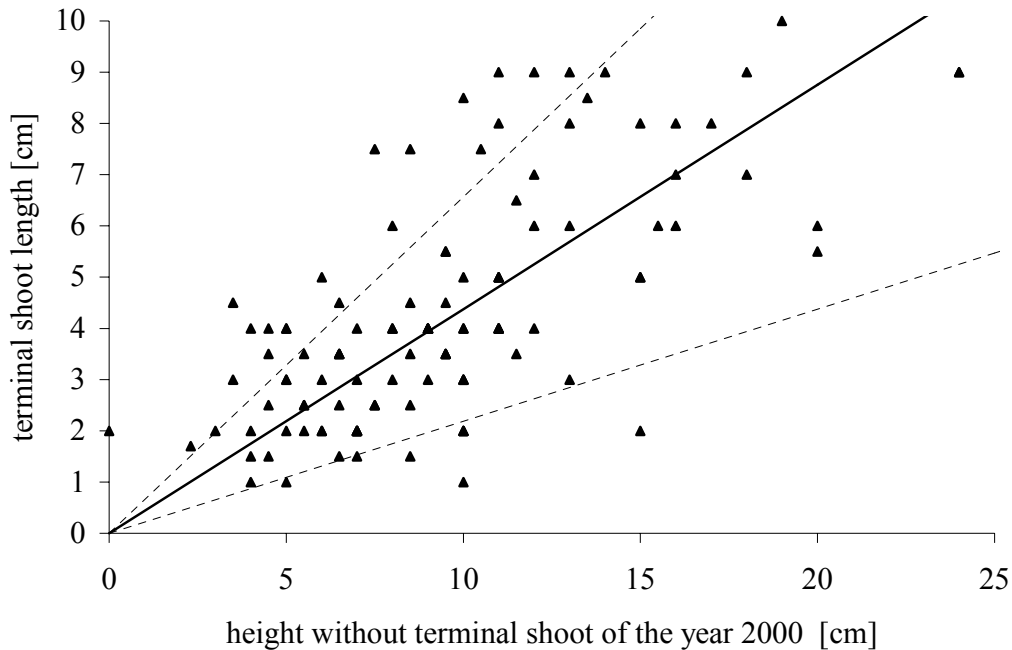

Fig. 3: Height increment of 113 unbrowsed randomly sampled *Picea abies* saplings on the subalpine level of the Gandberg forest. The solid line represents result of linear regression (equation 4), while dotted lines symbolise a height increment of 50% and 150% of the average, respectively.

In addition, the height and height increment of 69 unbrowsed *Picea* saplings were measured in a *Picea* thicket on the lower montane level beneath the snag stands in the Gandberg forest (same site conditions and also a north facing slope). Again, terminal shoot length exhibited a linear relationship to the height measured without the terminal shoot (cf. equation 5 and Fig. 4).

$$\text{average height increment } r_p = 11.2 + 0.078 * \text{height [cm]}, R^2 = 0.27, p < 0.001 \quad (5)$$

With equation 4, we calculated the average height increments of *Picea* saplings in the height classes 1-3 on the subalpine level (Table 1). However, there was no information about the height increment of taller *Picea* saplings on the subalpine level because no tree larger than ca. 35 cm was found in 2001 (cf. Fig. 3). For the taller saplings in classes 5-7 we therefore used equation 5, which has been derived from the randomly sampled *Picea* saplings on the montane level, and reduced this equation by 10% to account for the smaller growth on the subalpine level (equation 6, Table 1):

$$\text{average height increment } r_{p5-7} = 10 + 0.070 * \text{height [cm]} \quad (6)$$

In contrast, for the small *Picea* saplings at the montane level, we increased the slope of equation 4 by 10%, thus resulting in equation 7:

$$\text{average height increment } r_{P1-3} = 0.481 * \text{height} \text{ [cm]} \quad (7)$$

The average height increment of class 4 saplings (r_{P4}) was interpolated between r_{P3} and r_{P5} for both elevational levels (Table 1).

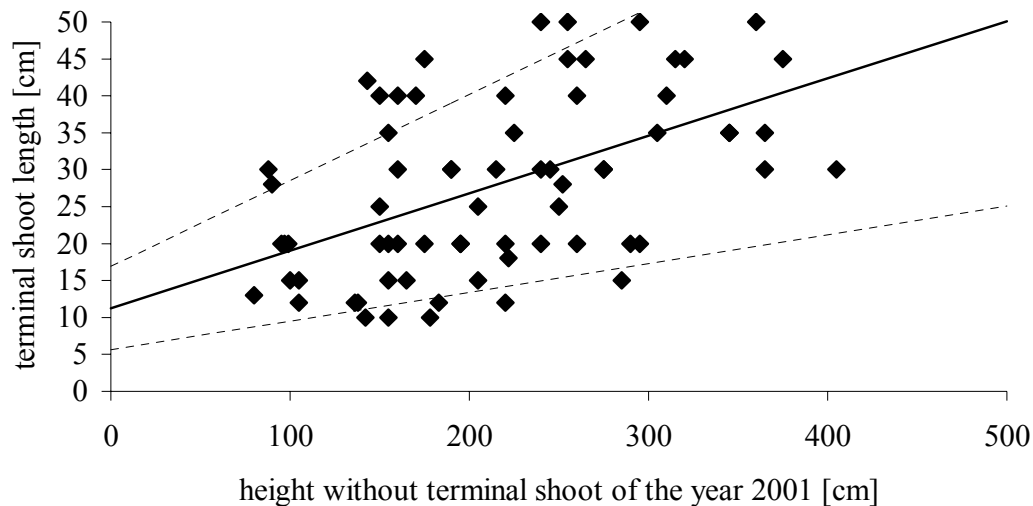

Fig. 4: Height increment of 69 unbrowsed *Picea abies* in a thicket of *Picea* saplings on the montane elevational level beneath the Gandberg forest. The solid line represents the result of linear regression (equation 5), while dotted lines symbolise a height increment of 50% and 150% of the average, respectively.

We would have preferred to use a logistic growth equation for the height increment of *Picea* on the montane level based only on measurements of *Picea* seedlings and saplings of 0 up to 5 m at the montane level, and to do the same for the subalpine level. Unfortunately, this was not possible with the available data. However, with the procedure described above, which is based based on the assumption of exponential growth within the first 3 height classes and within height classes 5-7, we obtained plausible height increments for each height class (cf. Table 1). Obviously, extrapolating these height increments to trees taller than about 5 m would not be reasonable due to the fact that an exponential growth function overestimates the growth of large trees.

Based on a literature survey, the microsite-specific height increments were estimated for each height class around the calculated mean values. Thereby, we took into account the range between the maximum and minimum values found in the randomly sampled trees at the Gandberg forest (Fig. 3 and 4). Hence, we assumed that saplings in a very

‘unfavourable’ habitat had only 50% of the average height increment, and saplings on a ‘favourable’ site 150% (Table 1, and see Appendix for the derivation of the microsite-specific rates).

Table 1: Germination rates (g), mortality rates of seedlings (m_0), annual mortality rates of saplings (m_{1-5}) and annual height increments (r_{1-7} [cm]) of *Picea abies* on the various microsite types in each height class (0: seeds, 1: 4-10 cm, 2: 10.1–20 cm, 3: 20.1-40 cm, 4: 40.1-70 cm, 5: 70.1–130 cm, 6: 130.1-250 cm, 7: 250.1-500 cm). Germination and mortality are fractions between 0 and 1, but height increment is listed in cm yr^{-1} . The signs stand for; --: 50% of mean rate, -: 75%, =: 100%, +: 125%, and ++: 150%. Note that m_{6-7} and r_{6-7} are not microsite-dependent. The microsite type ‘Other Vegetation’ (abbreviated with ‘Other Vege’) was mostly composed of *Senecio ovatus* on the montane (mont) level, and of *Vaccinium myrtillus* on the subalpine (sub) level.

microsite Type	<i>Picea abies</i>															
	g	m_0	m_1	m_2	m_3	m_4	m_5	m_6	m_7	r_1	r_2	r_3	r_4	r_5	r_6	r_7
Bare Soil	=	=	=	=	=	=	=	=	=	=	=	=	=	=	=	=
Oxalis	-	+	+	=	=	=	=	=	=	-	-	=	=	=	=	=
Root: mont	++	-	=	=	=	=	=	=	=	---	---	-	-	-	-	-
sub	++	---	---	-	-	-	-	-	-	---	---	-	-	-	-	-
Moss-Boulder	+	+	+	=	=	=	=	=	=	=	=	-	-	-	-	-
Polytrichum	=	+	=	=	=	=	=	=	=	=	=	=	=	=	=	=
Hylocomium	-	+	=	=	=	=	=	=	=	=	=	=	=	=	=	=
Other Moss	+	+	=	=	=	=	=	=	=	+	+	=	=	=	=	=
Fern	=	++	++	++	++	++	++	=	=	-	-	-	-	=	=	=
Rubus	---	++	++	++	++	++	++	+	+	---	---	---	---	---	---	---
Moss-Rubus	=	+	+	+	+	+	+	+	+	=	=	=	=	=	=	=
Moss-Fern	=	+	+	+	+	+	+	=	=	=	=	=	=	=	=	=
CWD: mont	++	-	=	=	=	=	=	=	=	---	---	-	-	-	-	-
sub	++	---	-	-	-	-	-	-	-	---	---	-	-	-	-	-
Fern-Rubus	---	++	++	++	++	++	++	++	++	---	---	---	---	---	---	---
Grass	---	++	++	++	++	++	+	=	=	=	=	=	=	=	=	=
Other Vege (Senecio)	=	=	+	+	+	+	+	+	+	-	-	-	=	=	=	=
(Vaccinium)	=	+	+	+	+	=	=	=	=	=	=	=	=	=	=	=
Sambucus	=	=	=	-	-	-	-	-	-	+	+	+	+	+	+	+
Betula	+	=	=	-	-	-	-	-	-	+	+	+	+	+	+	=
Sorbus	+	=	=	-	-	-	-	-	-	+	+	+	+	+	+	+
Picea	-	+	++	++	++	++	++	++	++	=	=	=	=	=	=	=
Acer	+	=	=	-	-	-	-	-	-	+	+	+	+	+	+	+
mean on the montane level	0.3									3.4	7.2	14.4	16.0	18.9	26.0	40.4
mean on the subalpine level										3.1	6.6	13.1	14.5	17.0	23.3	36.3

The height increment of *Picea* saplings on the montane level of the Gandberg forest (Fig. 4) was similar to that on windthrow areas in the Swiss Alps (Schönenberger 2002). Only the small saplings grew faster on the subalpine level of the Gandberg forest (Fig. 3) than on the windthrow areas Schwanden, Pfäfers, Disentis and Zweisimmen (Schönenberger, unpublished). We therefore assumed that height increment was also similar between these sites in the case of *Betula pendula*, *Sorbus aucuparia* and *Acer pseudoplatanus*. Furthermore, height increments of the few *Betula* saplings in these windthrow areas were similar to those measured and described by Jogiste *et al.* (2003) in Estonia (equation 8):

$$r_B = 11.16 + 0.222 * \text{height [cm]} \quad (8)$$

Hence, height increment of birch saplings (Table 2) was assumed to be much higher than for *Picea* (Table 1).

Table 2: Germination rates (g), mortality rates of seedlings (m_0), annual mortality rates of saplings (m_{1-5}), and annual height increments (r_{1-7} [cm]) of *Betula pendula* on the various microsite types in each height class on the montane level of the Gandberg. For further explanations, see Table 1.

microsite Type	<i>Betula pendula</i>										r_1	r_2	r_3	r_4	r_5	r_6	r_7
	g	m_0	m_1	m_2	m_3	m_4	m_5	m_6	m_7								
Bare Soil	++	---	---	---	---	---	---				+	+	+	+	+		
Oxalis	+	-	-	-	-	-	-				+	+	+	+	+		
Root	-	+	=	=	=	=	=				-	-	-	-	-		
Moss-Boulder	=	=	=	=	=	=	=				=	=	=	=	=		
Polytrichum	=	=	=	=	=	=	=				=	=	=	=	=		
Hylocomium	=	=	=	=	=	=	=				=	=	=	=	=		
Other Moss	+	=	=	=	=	=	=				=	=	=	=	=		
Fern	-	+	++	++	++	+	=				-	-	-	=	=		
Rubus	---	+	++	++	++	++	++				-	-	-	-	-		
Moss-Rubus	---	=	+	+	+	+	+				-	-	-	-	-		
Moss-Fern	---	=	+	+	+	=	=				-	-	-	=	=		
CWD	=	+	=	=	=	=	=				-	-	-	-	-		
Fern-Rubus	---	+	++	++	++	++	++				-	-	-	-	-		
Grass	-	=	+	+	+	=	=				-	-	-	=	=		
Other Vege (Senecio)	-	=	+	+	+	+	=				-	-	-	-	=		
Sambucus	-	=	+	+	+	+	+				-	-	-	-	-		
Betula	---	+	++	++	++	++	++				---	---	---	---	---		
Sorbus	---	+	++	++	++	++	++				---	---	---	---	---		
Picea	---	+	++	++	++	++	++				---	---	---	---	---		
Acer	---	+	++	++	++	++	++				---	---	---	---	---		
mean on the montane level	0.4	0.1	0.2	0.1	0.08	0.03	0.02	0.01	0.005		13	15	18	23	33	53	95

Sorbus aucuparia and *Acer pseudoplatanus* are heavily browsed by chamois on the Gandberg forest (cf. Kupferschmid *et al.* 2002 and Table 5). Hence, we implemented *Sorbus* and *Acer* regeneration in a simpler manner than *Picea* or *Betula* regeneration, i.e. by abandoning microsite-specific rates and only using mean germination, mortality and growth rates (Table 3 and 4).

Table 3: Germination rates (g), mortality rates of seedlings (m_0) and saplings (m_{1-5}) and annual height increments (r_{1-7} [cm]) of *Sorbus aucuparia* in each height class (0: seeds, 1: 4-10 cm, 2: 10.1–20 cm, 3: 20.1-40 cm, 4: 40.1-70 cm, 5: 70.1–130 cm, 6: 130.1-250 cm, 7: 250.1-500 cm) and elevational level (mont = montane, sub = subalpine level).

level		<i>Sorbus aucuparia</i> height classes							
		0	1	2	3	4	5	6	7
G	mont + sub	0.4							
M	mont + sub	0.1	0.2	0.1	0.08	0.03	0.02	0.01	0.005
r [cm]	mont		5.0	9	16.0	18.0	20	26.0	32.0
r [cm]	sub		4.5	8.1	14.4	16.2	18	23.4	28.8

Table 4: Germination rates (g), mortality rates of seedlings (m_0) and saplings (m_{1-5}) and annual height increments (r_{1-7} [cm]) of *Acer pseudoplatanus* per height class (0: seeds, 1: 4-10 cm, 2: 10.1–20 cm, 3: 20.1-40 cm, 4: 40.1-70 cm, 5: 70.1–130 cm, 6: 130.1-250 cm, 7: 250.1-500 cm) and elevational level (mont = montane, sub = subalpine).

level		<i>Acer pseudoplatanus</i> height classes							
		0	1	2	3	4	5	6	7
G	mont + sub	0.5							
M	mont + sub	0.05	0.05	0.04	0.03	0.02	0.01	0.005	0.001
r [cm]	mont		3.4	7.2	14.4	18	22	30	45
r [cm]	sub		3.1	6.6	13.1	16.2	19.8	27	40.5

3.3.3 Browsing intensity

In the model, browsing was assumed to be distributed uniformly within a height class, i.e. all saplings were browsed with the same probability. Therefore, it was assumed that single terminal-shoot losses that resulted from ungulate browsing can be summed up to derive the total annual height increment loss. The total height increments of a species in each height class were therefore reduced each year by the browsing intensity estimated in Table 5. This procedure was chosen because no individual trees were modelled with our height-class approach.

The Gandberg forest lies within the wildlife sanctuary ‘Freiberg Kärfpf’. Therefore, chamois (*Rupicapra rupicapra*) are very frequent (Schmidt 1983). Consequently, the terminal shoots of 9 out of 13 living *Picea* saplings were browsed in 2001 in the 24 permanent plots in the Gandberg forest (Kupferschmid *et al.* 2002). This is equal to a browsing intensity of about 70% for *Picea* in height class 2 and 3 (Table 5). Generally, browsing by chamois affects saplings of less than about 1.3 m height (Eiberle and Nigg 1986), in particular saplings of about 10-40 cm, i.e. saplings in the height classes 2-3 of our model. Saplings in height class 1 are browsed less often than taller ones (Eiberle and Nigg 1986, Wunder 2002). Hence we assumed a lower browsing intensity in class 1 (Table 5). However, seedlings and small saplings may die due to browsing. For example, Rüegg and Schwitter (2002) observed in windthrow areas an annual mortality rate due to browsing of about 5% for *Picea abies*. Due to the very high browsing pressure on the Gandberg forest (see above), we assumed a lethal browsing damage of about 15% per year (Table 5). In the model, this browsing-induced mortality rate increased the normal mortality rate of seedlings and saplings in the first height class (m_1 , Table 1).

Browsing intensities were assumed to be equal on all microsite types due to a lack of microsite-specific data. However, according to personal observations in the Gandberg forest, browsing pressure was probably higher in winter on the montane than on the subalpine level, presumably because of the lower montane snow depth. Therefore, browsing intensities on the subalpine level were assumed to be about half the intensities on the montane level (cf. Table 5), except for *Picea* seedlings in the first height class because the ground vegetation was generally less tall on the subalpine level, which resulted in a better detectability of seedlings.

Table 5: Estimated browsing intensities (br, i.e. annual probability that terminal shoot is browsed) and mortalities induced by ungulates (bm, i.e. annual probability of death due to browsing by ungulates in height class 1) on *Picea abies*, *Sorbus aucuparia*, *Acer pseudoplatanus* and *Betula pendula* in the various height classes of the montane and subalpine elevational level of the Gandberg forest.

species		height classes				
		1		2 - 3	4	5
		4-10 cm		10.1-40 cm	40.1 – 70 cm	70.1-130 cm
		bm [%]	br [%]	br [%]	br [%]	br [%]
<i>Picea</i>	montane	15	10	70	40	20
	subalpine		30	35	20	10
<i>Sorbus</i> And <i>Acer</i>	montane	30	50	80	70	60
	subalpine		50	75	65	55
<i>Betula</i>	montane	0	0	0	0	0

Furthermore, we generally assumed a higher browsing intensity on *Sorbus aucuparia* (e.g. Ott *et al.* 1991, Nüsslein and Faisst 1998, Wunder 2002) and *Acer pseudoplatanus* than on *Picea*, as we found no unbrowsed *Acer* sapling in the permanent plots. As ungulates preferentially browse these two species and seedlings and saplings are easier to detect on the subalpine level, we assumed a reduction in browsing intensity on saplings of about 5% compared with the montane level (Table 5). In contrast, *Betula* seedlings and saplings was supposed to be unattractive for chamois and therefore not browsed (Table 5).

Although there were some *Abies alba* trees on the Gandberg forest, we ignored *Abies* and *Salix* in our tree regeneration model because only very few seedlings were found in the permanent plots (cf. Fig. 2), and *Abies* is browsed even more than *Acer* (i.e., 100% regeneration failure of *Abies* in the Gandberg, Kupferschmid *et al.* 2002).

4. Sampling for model validation

In June 2001, tree regeneration was investigated on the Gandberg forest in those *Picea abies* stands in which *Picea* trees had died in 1993. Sampling took place at 3 elevational levels (lower montane: 1220-1280 m a.s.l., upper montane: 1310-1370 m and upper subalpine: 1540-1600 m). At each of the three elevational levels, eight groups of strip transects were randomly selected. Each transect group contained four transects which were parallel ('E-W'), perpendicular ('N-S') and at an angle of 45° to the contour lines ('N-W', 'N-E'). A strip transect was 10 m long and 2 m wide. Along these 96 strip transects (3 elevational levels x 8 groups x 4 transects per group), the following characteristics were measured/determined for each tree seedling and sapling: height (the terminal shoot of 2001 was not included), terminal shoot increment in 2000, browsing and other damages, and the microsite type.

5. Simulation scenarios and sensitivity analysis

Short-term and long-term simulations were performed with different parameter sets for the two elevational levels of the Gandberg (i.e. montane and subalpine). Short-term simulations over 8 years were used to compare the simulation results with independent field data (validation of the model). Long-term simulations, in contrast, were carried out (i) to project the numbers and height distribution of tree regeneration into the future and (ii) to predict the future tree species composition of the snag stands in the Gandberg forest.

In addition, a parameter sensitivity analysis was conducted to answer the following main question: Is it important to differentiate microsite-specific rates of germination, mortality and growth, or would it be sufficient to use average rates? Eight different simulation scenarios were carried out over 8 years for *Picea abies* (Table 6), so that the model output could be compared with the independent field data (validation data set).

Table 6: Possible combinations between microsite-specific (s) and average (a) rates of germination (g), mortality (m) and growth (r).

	g_a	g_s
m_a	$g_a m_a r_a$	$g_s m_a r_a$
	$g_a m_a r_s$	$g_s m_a r_s$
m_s	$g_a m_s r_a$	$g_s m_s r_a$
	$g_a m_s r_s$	$g_s m_s r_s$

In addition, we carried out a sensitivity analysis for the effect of browsing intensity on the number and height of *Picea abies* trees. The default browsing intensity of 70% in class 2 and 3 (Table 5) was increased or decreased by 1%, 5%, 10% and 20%, resulting in browsing intensities between 50 and 90%.

6. Simulation results

6.1 Short-term simulation compared with independent field data

6.1.1 Frequency of *Picea abies* in each microsite type

Montane level

First, we calculated the relative frequency of *Picea abies* seedling and sapling numbers on each microsite type. The largest differences between simulated and observed frequencies were found for the microsite types dominated by *Rubus idaeus* (Fig. 5). That is, the numbers of *Picea* on ‘Fern Rubus’ and ‘Rubus’ were overestimated considerably, while the numbers on ‘MossRubus’ were underestimated. Apart from these differences, the numbers of *Picea* on all moss microsite types and on ‘Other Vegetation’ were underestimated, and on the microsite type ‘Fern’ they were overestimated (Fig. 5).

The scenario with only average rates, i.e. ga-ma-ra, always gave the poorest agreement between observed and simulated data (Fig. 5). Hence, *Picea* was not distributed uniformly across the microsite types. Compared to the ‘all average scenario’, microsite-specific rates of germination (gs-ma-ra) or microsite-specific rates of mortality (ga-ms-ra) considerably improved the agreement with the observed frequencies. However, the simulated frequencies were closest to the observed data when all rates were assumed to be microsite-specific (gs-ms-rs, Fig. 5).

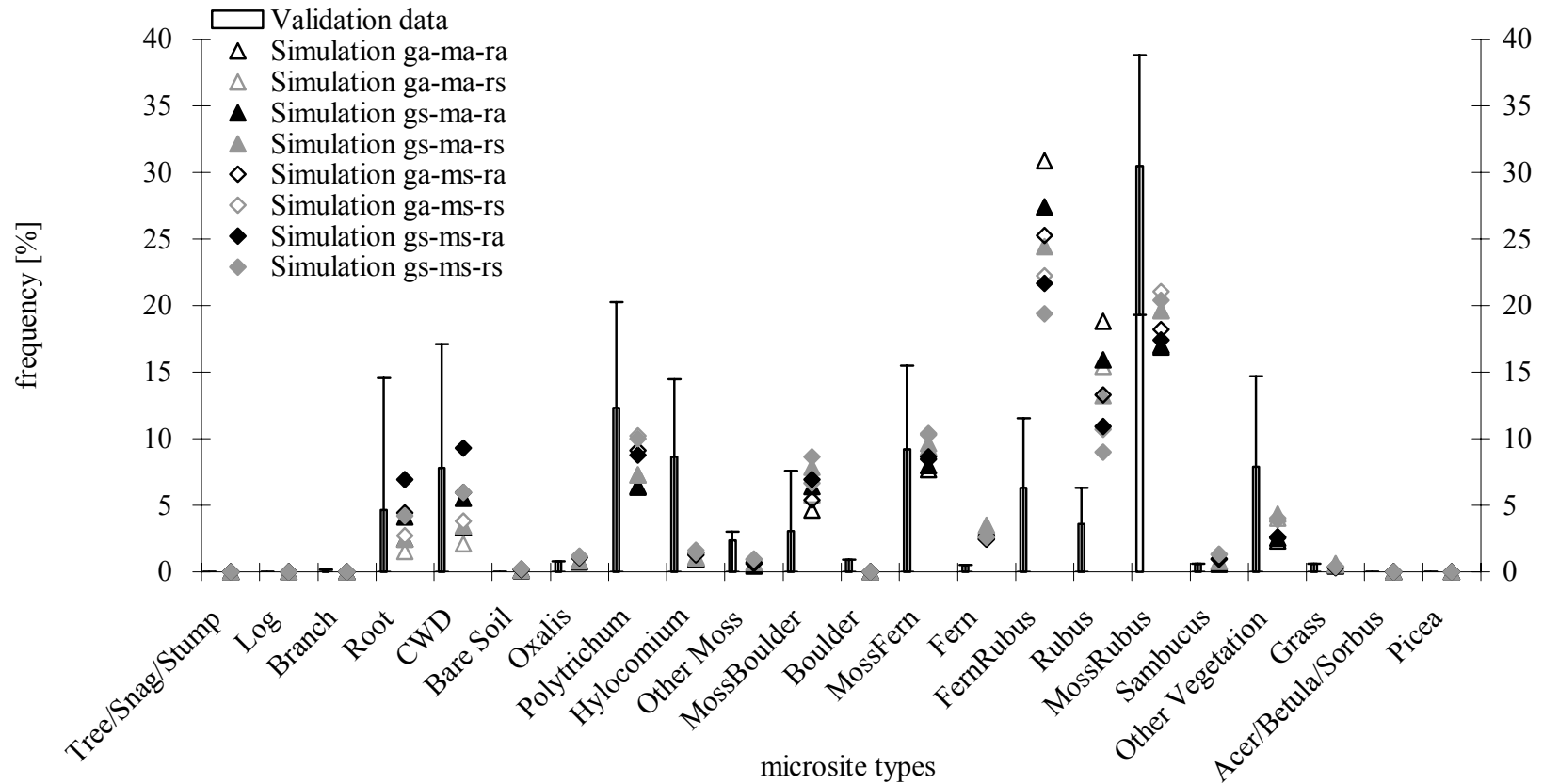

Fig. 5: Relative frequencies of the number of *Picea abies* seedlings and saplings on different microsite types on the montane level in 2001. A comparison of simulated and observed frequencies is shown. Validation data were from the 16 strip transects on the montane level of the Gandberg snag stands (bars = average of 16 strip transects, lines = standard deviation). Simulations were carried out over 8 years with average values (a) or microsite-specific values (s) of the rates of germination (g), mortality (m) and height increment (r).

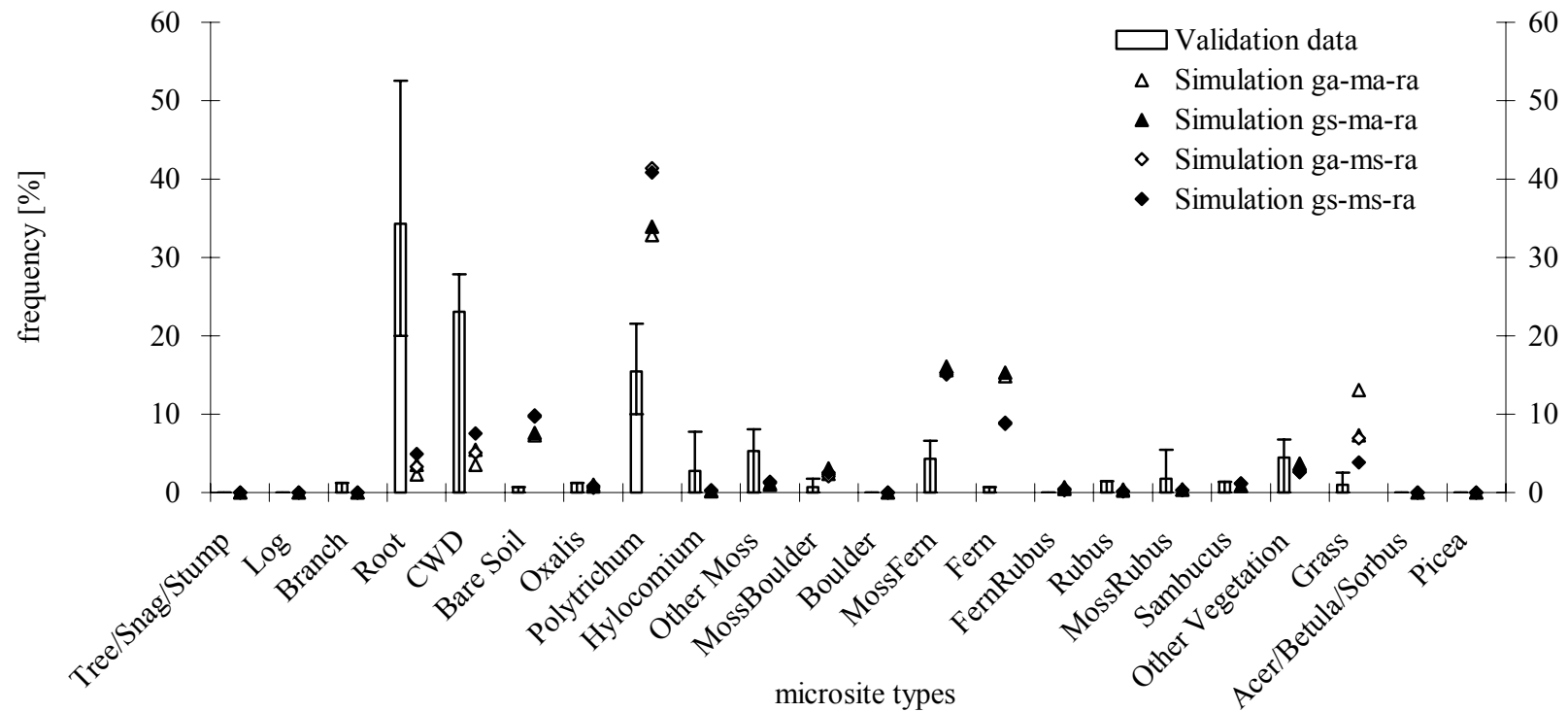

Fig. 6: Relative frequencies of the number of *Picea abies* seedlings and saplings on different microsite types on the subalpine level in 2001. A comparison of simulated and observed frequencies is shown. Validation data were from the 8 strip transects on the upper-subalpine level of the Gandberg snag stands (bars = average of 8 strip transects, lines = standard deviation). Simulations were carried out over 8 years with average values (a) or microsite-specific values (s) of the rates of germination (g) and mortality (m). Were only filled symbols are visible, the simulation with average and microsite-specific germination rates gave identical results. Simulation results with microsite-specific height increments (rs) are not shown because they were found almost indistinguishable to results with average growth rates (ra).

Subalpine level

The agreement between simulated and observed frequencies of *Picea* seedlings and saplings in each microsite type was generally lower on the subalpine than on the montane level. In particular, the numbers of *Picea* on the microsite types ‘Bare Soil’, ‘Polytrichum’, ‘MossFern’, ‘Fern’ and ‘Grass’ were strongly overestimated with the model for the subalpine level (Fig. 6). In contrast, the frequencies of trees on the microsite types ‘Hylocomium’, ‘Other Mosses’ and above all on ‘Root’ and ‘Coarse Woody Debris’ (‘CWD’) were underestimated (Fig. 6).

Microsite-specific germination and mortality rates were important in explaining the differences between a uniform distribution of *Picea* on all microsite types (scenario ga-ma-ra) and the observed distribution (Fig. 6).

6.1.2 Frequency of tree regeneration in each height class

Montane level

The numbers of *Picea* in each height class varied strongly between the 8 simulation scenarios (defined in Table 6, cf. Fig. 7). In particular, microsite-specific rates of growth and mortality had a large effect on the numbers of trees in each height class (Fig. 7). As expected, microsite-specific germination rates had no influence on the number of *Picea* in each height class, but only on the distribution of the trees across the microsite types (cf. Fig. 5).

Overall, 1961 *Picea* seedlings and saplings per ha were observed on the montane level of the Gandberg forest in 2001, while 2091 ha⁻¹ resulted for the simulation where all rates were assumed to be microsite-specific (i.e. gs-ms-rs, cf. Fig. 7). We would like to emphasise that no *Picea* regeneration taller than 70 cm was found on the Gandberg forest 8 years after *Picea* die-back, a feature reproduced by the simulations over 8 years (cf. only trees in classes 1-4, Fig. 7). In addition, most *Picea* saplings were found in height class 2 (10.1 – 20 cm) on the Gandberg forest (54.6%) and also in the gs-ms-rs simulation scenario (59.4%, cf. Fig. 7).

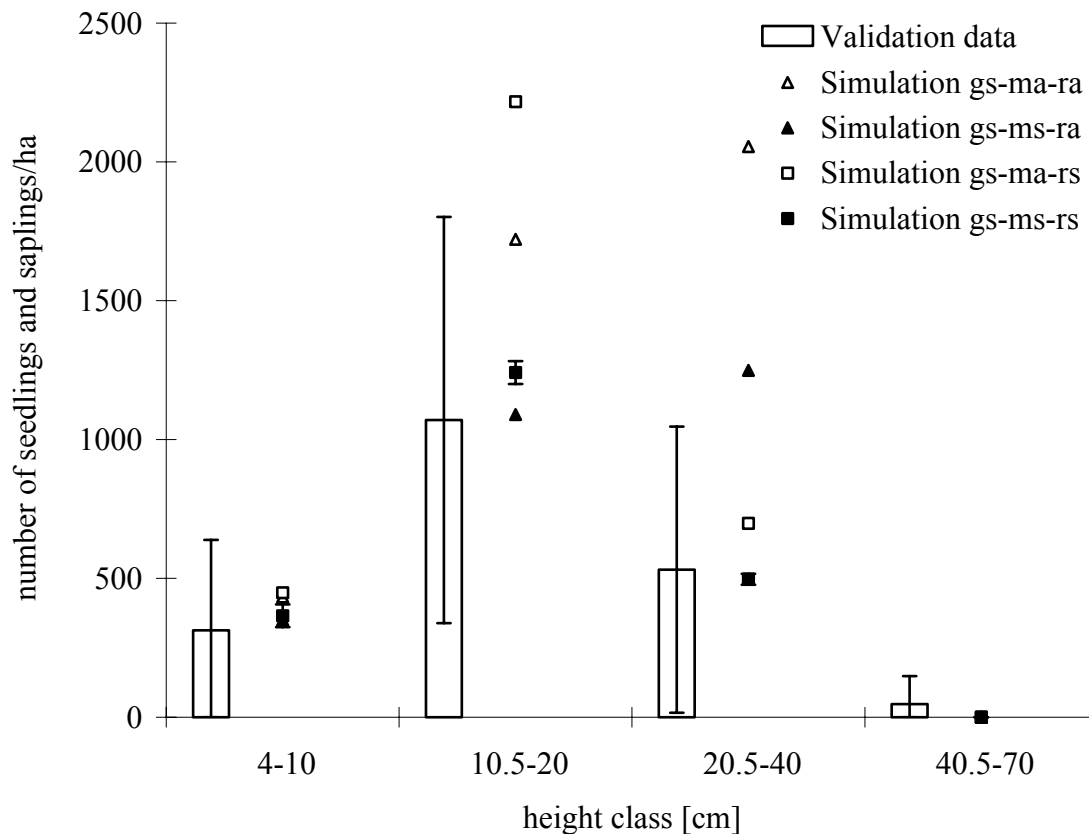

Fig. 7: Number of *Picea abies* seedlings and saplings in each height class on the montane level in 2001. A comparison of simulated and observed tree numbers is shown. Validation data were from the 16 strip transects on the montane level of the Gandberg snag stands (bars = average of 16 strip transects, lines = standard deviation). Simulations were carried out over 8 years with average values (a) or microsite-specific values (s) of the rates of mortality (m) and height increment (r). Simulation results with average germination rates (ga) are not shown because they were found to be almost indistinguishable to the results with microsite-specific germination rates (gs). As described in the Appendix we used the random function of STELLA® for the seed input in non mast years ($0\text{--}1'000$ seeds ha^{-1}). Mean value and standard deviation is shown for the 10 simulation runs where all rates were assumed to be microsite-specific (gs-ms-rs), while for the other simulations only the mean values are shown.

The simulated numbers of seedlings and saplings of *Sorbus aucuparia* agreed also well with the observed numbers on the Gandberg (Fig. 8). In contrast, the observed numbers of the other two tree species included in our model, *Betula pendula* and *Acer pseudoplatanus*, were simulated more closely when using a reduced random seed inflow number (5% and 50%, cf. Fig. 8). As explained in the parameterisation in the Appendix, *Betula* and *Acer* saplings were more frequent in our permanent plots than in the surroundings, and this may explain the overestimation evident from the original simulation.

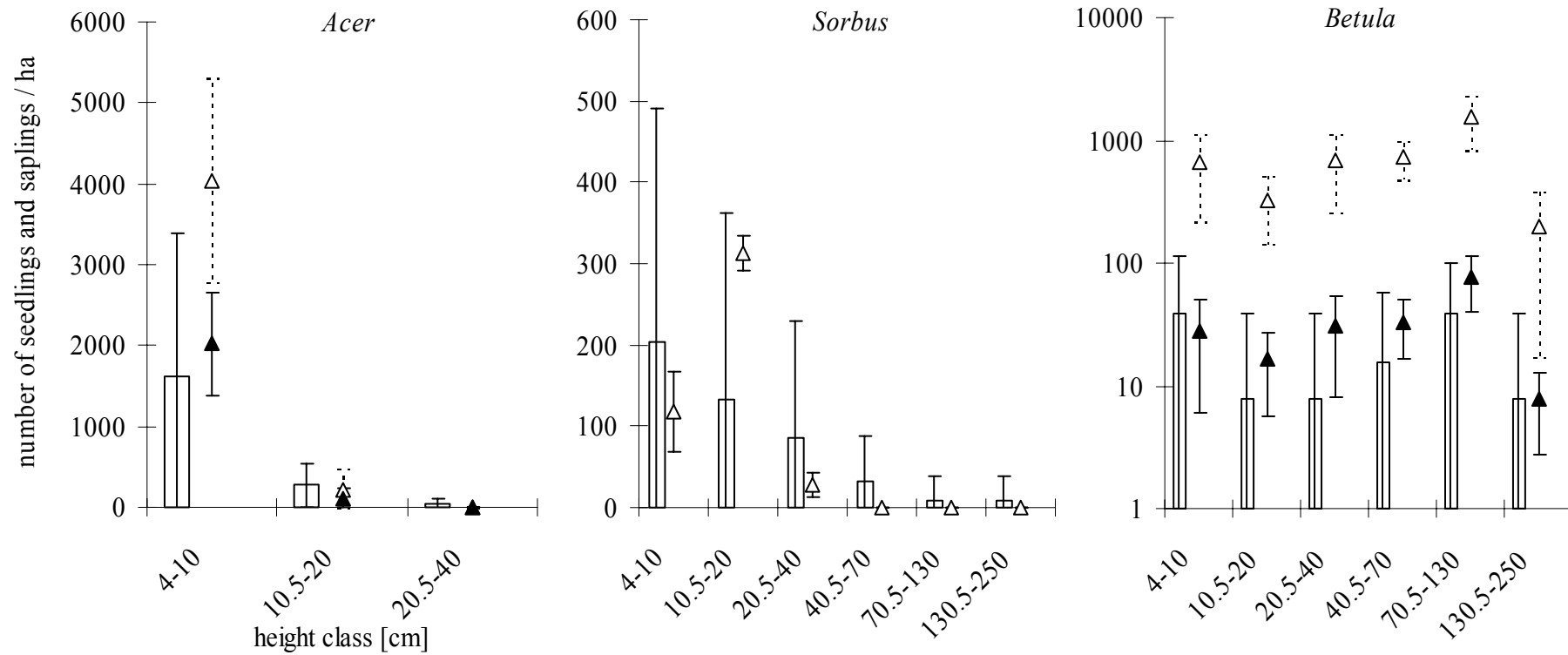

Fig. 8: Number of seedlings and saplings of *Acer pseudoplatanus*, *Sorbus aucuparia* and *Betula pendula* in each height class on the montane level in 2001. A comparison of simulated and observed tree numbers is shown. Bars stand for the average numbers of trees sampled in the 16 strip transects at the montane level of the Gandberg forest (i.e. validation data including standard deviation). Open triangles are the results of simulations over 8 years with the random annual seed inflow for the montane level which were estimated according to the germinants found in the permanent plots (*Acer*: 0-8'000 seeds $\text{ha}^{-1}\text{yr}^{-1}$, *Sorbus*: 8'000 ha^{-1} in 1993, else 0-500 seeds $\text{ha}^{-1}\text{yr}^{-1}$, *Betula*: 0-7'000 seeds $\text{ha}^{-1}\text{yr}^{-1}$ and g, m, and r are microsite-specific, cf Appendix). Filled triangles show simulations with a reduced annual seed inflow: in the case of *Acer* 0-4'000 seeds $\text{ha}^{-1}\text{yr}^{-1}$ and for *Betula* 0-350 seeds $\text{ha}^{-1}\text{yr}^{-1}$. Thereby, the mean values and standard deviations of the 10 simulation runs are shown.

Subalpine level

Again, the numbers of *Picea abies* on each height class varied strongly between the 8 simulation scenarios (Fig. 9). Thereby, microsite-specific rates of growth had the largest effect on the numbers of trees, in particular in the second height class (Fig. 9).

Overall, 3047 *Picea* seedlings and saplings per ha were observed on the subalpine level of the Gandberg forest in 2001, while 3023 ha⁻¹ resulted for the simulation where all rates were assumed to be microsite-specific (i.e. gs-ms-rs, cf. Fig. 9). This higher amount of *Picea* seedlings and saplings on the subalpine than on the montane level is the result of the three time higher seed inflows on the subalpine level during the mast year 1995 (66'000 instead of 22'000 seeds ha⁻¹), the partial mast years 1997 and 1999 (9'000 instead of 3'000 seeds ha⁻¹yr⁻¹), and the other years (3'000 instead of 1'000 seeds ha⁻¹yr⁻¹).

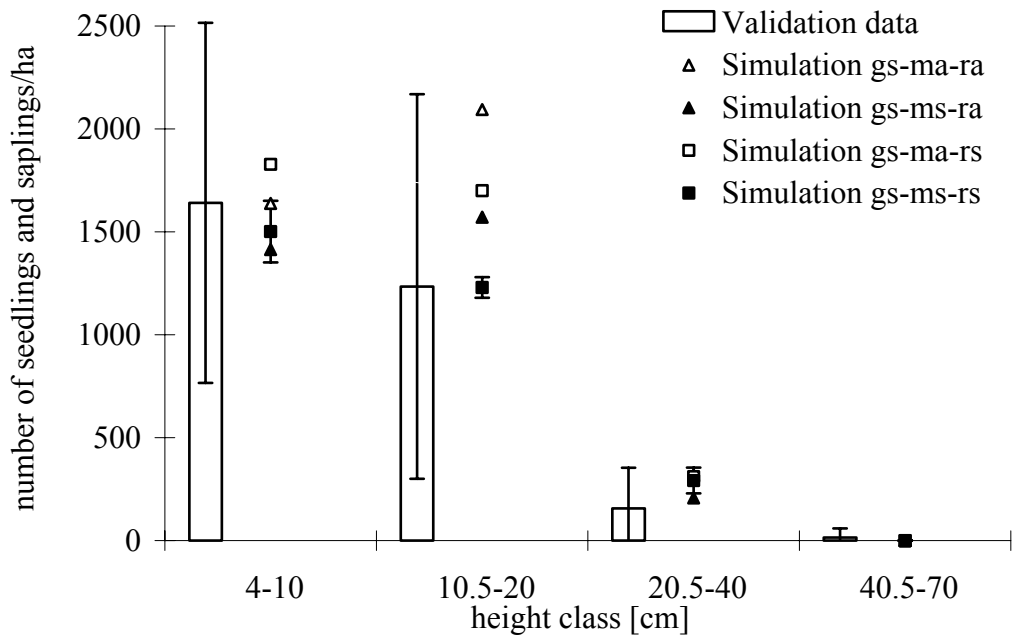

Fig. 9: Number of *Picea abies* seedlings and saplings in each height class on the subalpine level in 2001. A comparison of simulated and observed tree numbers is shown. Validation data were from the 8 strip transects on the upper-subalpine level of the Gandberg snag stands (bars = average of 8 strip transects, lines = standard deviation). Simulations were carried out over 8 years with average values (a) or microsite-specific values (s) of the rates of mortality (m) and height increment (r). Simulation results with average germination rates (ga) are not shown because they were found to be almost indistinguishable to the results with microsite-specific germination rates (gs). As described in the Appendix we used the random function of STELLA® for the seed input in non mast years (0-3'000 seeds ha⁻¹yr⁻¹). Mean value and standard deviation is shown for the 10 simulation runs where all rates were assumed to be microsite-specific (gs-ms-rs), while for the other simulations only the mean values are shown.

Similar to the montane level, no *Picea* regeneration taller than 70 cm was found on the subalpine level of the Gandberg forest 8 years after *Picea* die-back (cf. only trees in classes 1-4, Fig. 9). But, in contrast to the montane level, *Picea* seedlings and saplings on the subalpine level were mostly found in height class 1, followed by class 2. Both features were well reproduced by the gs-ms-rs simulation scenario for the subalpine level.

The simulated and observed amounts of *Acer* and *Sorbus* were quite similar on the subalpine level, in particular in the case of *Sorbus* (Fig. 10). In total, 156 *Acer* and 1000 *Sorbus* seedlings and saplings ha^{-1} were found on the Gandberg forest and 264 *Acer* and 1014 *Sorbus* were simulated with our model for the subalpine level (Fig. 10). *Acer* was therefore less frequent on the subalpine than on the montane level (1938 seedlings and saplings ha^{-1}), while *Sorbus* was more abundant on the subalpine level (469 ha^{-1} on the montane level).

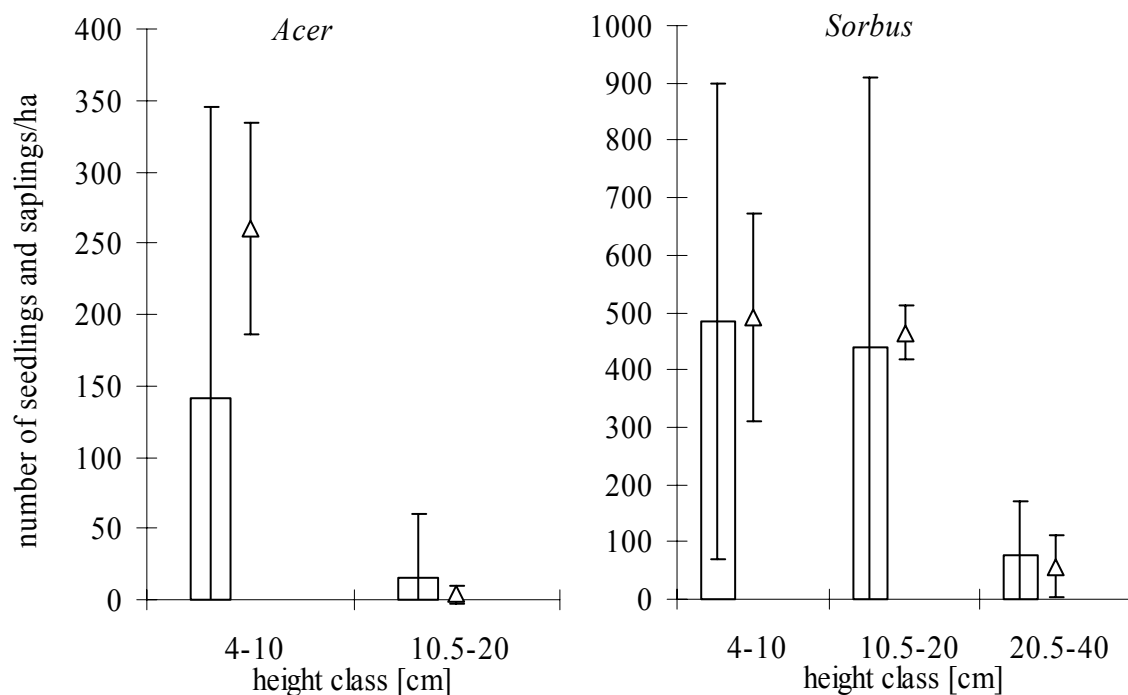

Fig. 10: Number of seedlings and saplings of *Acer pseudoplatanus* and *Sorbus aucuparia* in each height class on the subalpine level in 2001. Bars stand for the average numbers of trees sampled in the 8 strip transects at the subalpine level of the Gandberg forest (i.e. validation data including standard deviation). Open triangles represent the simulations over 8 years with the random annual seed inflow for the subalpine level (*Acer*: 0-500 seeds $\text{ha}^{-1}\text{yr}^{-1}$, *Sorbus*: 16'000 ha^{-1} in 1993, else 0-2'000 seeds $\text{ha}^{-1}\text{yr}^{-1}$, cf Appendix). Thereby, the mean values and standard deviations of the 10 simulation runs are shown.

6.1.3 Browsing intensity

Browsing intensity in the height classes 2-3 had a considerable influence on the simulated amounts of *Picea abies* saplings in each height class (Fig 11). Similarly, the browsing intensity and the browsing mortality in class 1 were highly important (results not shown).

We assumed a mean browsing intensity on *Picea* of 70% in the model for the montane level (cf. Table 5), according to the data from the permanent plots (see parameterisation section). During the validation data sampling on the Gandberg forest, however, a mean browsing intensity of less than 25% was observed in the year 2000 on the montane level (Kupferschmid submitted). However, when our simulated numbers with a reduction in height increment of only 50-60% are compared with the observed amounts in the validation data of the Gandberg, the *Picea* saplings in the simulation are much taller than was observed (Fig. 11). This cannot be explained with too large height increments in the model with the montane parameters, because the estimated increments were based on equation 7 with a slope of 0.481 in the linear regression between height increment and height, while the increments calculated with the validation data of never visibly browsed saplings has a slope of 0.489 (Fig. 12). However, browsing intensities were assumed to be constant every year in the model, while in reality browsing pressure varies between years (e.g. Kupferschmid submitted, Rüegg and Schwitter 2002). We therefore assume that the validation data reflect a year with low browsing pressure.

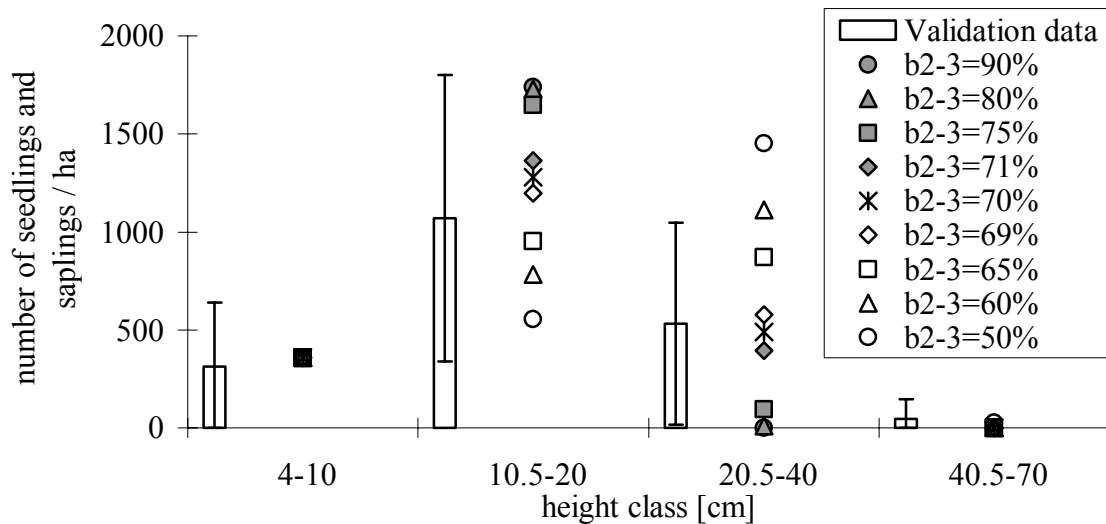

Fig. 11: Number of seedlings and saplings of *Picea abies* in each height class and browsing rate on the montane level in 2001. Bars stand for the mean values in the 16 strip transects on the montane level of the Gandberg snag stands (i.e. validation data including standard deviation). Squares, dots and diamonds represent simulations over 8 years with different browsing intensities, i.e. with different reductions of the height increment in the height classes 2-3. The default browsing intensity of 70% (Table 5) is marked in bold in the figure legend.

Our assumption that *Picea* was browsed about half as often on the subalpine as on the montane level was in contrast correct, even though on a lower level (cf. Table 5 and Fig. 12, Kupferschmid submitted). We therefore nevertheless performed our long-term simulations with the originally estimated height increment reduction by browsing (Table 5).

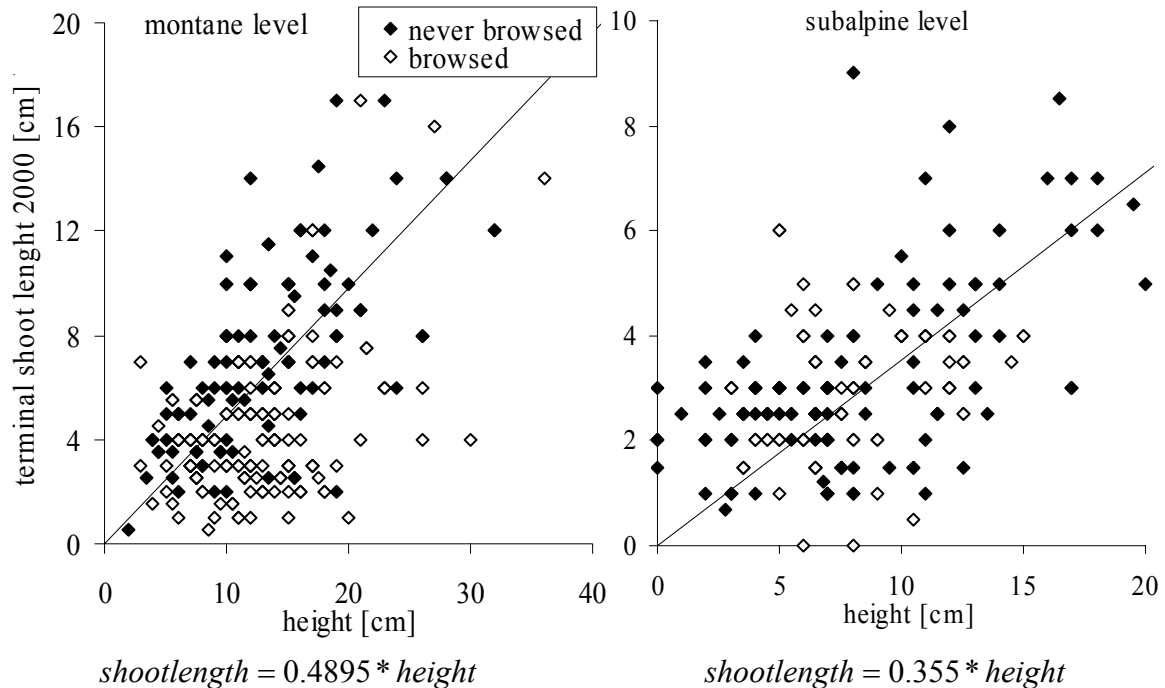

Fig. 12: Height increment of 446 measured *Picea abies* saplings in strip transects on the montane (N = 251) and subalpine level (N = 195) of the Gandberg forest (validation data): height was measured without the terminal shoot of the year 2000. Linear regressions were calculated only with unbrowsed saplings: ($R^2 = 0.29$ and 0.15). On average, 42.6% of the *Picea* saplings have been browsed at least once on the montane level between 1996 and 2000, but only 22.6% on the subalpine level.

6.2 Long-term simulations

6.2.1 Montane level

The total number of *Picea* saplings declined in the first years (Fig. 13), due to mortality and the higher amounts of seeds at the end of 1993 and 1995 than afterwards. When only the sapling cohorts of 1994 and 1996 (germinated in the model in week 51 of the years 1993 and 1995) are simulated over time, their amount decreased to about $330 \text{ trees ha}^{-1}$ after about 35 years (cf. Fig. 13), while their average height increased (note that class 8 in the model with trees taller than 5 m had no height increment and mortality, therefore the steady-state values in the top right part of the Fig. 13). As expected from the random seed amounts, the inflow of seeds in later years was irregular. Coarse woody debris ('CWD') became one of the most important microsite

types for *Picea* regeneration (Fig. 14). According to our rating in Table 1, *Betula pendula*, *Sorbus aucuparia* and *Acer pseudoplatanus* thickets are also ‘favourable’ microsite types for *Picea* establishment. Hence, after 30 simulation years about 6.4% of the *Picea* seedlings and saplings were found on these microsite types (cf. ‘Betula/Sorbus/Acer’ in Fig. 14).

The microsite types ‘Betula’, ‘Sorbus’, and ‘Acer’ together covered 1.6% of the area (Fig. 14), which was slightly greater than the area covered by the microsite type ‘Picea’ (1.3%). As trees that are taller than 1.3 m, i.e. classes 6-8, were assumed to dominate their microsite type and therefore to represent their own microsite type (‘Betula’, ‘Sorbus’, ‘Acer’ or ‘Picea’), it can be concluded that in the snag stands on the montane level, somewhat higher numbers of the deciduous trees established than of *Picea*. This was mostly due to their good germination ability on open sites and the absence of browsing for *Betula* saplings. However, the future frequencies of single microsite types cannot be taken literally because the proportion of the area which changed into a tree microsite type when a tree reached the height of 1.3 m (i.e. 0.125-0.5 m²) was probably underestimated. For example, the anticipated ca. 3.3 *Picea* saplings per 100 m² (= 330 trees ha⁻¹) that are taller than 1.3 m in the year 2023 (cf. white bar and dotted line in Fig. 13), would probably occupy more space than only about 1.3 m² (i.e. 1.3% of the area, cf. white bar in Fig. 14). Nevertheless, these long-term simulations show that coarse woody debris (‘CWD’), logs and *Rubus idaeus* will probably cover the largest fraction of the area at that time.

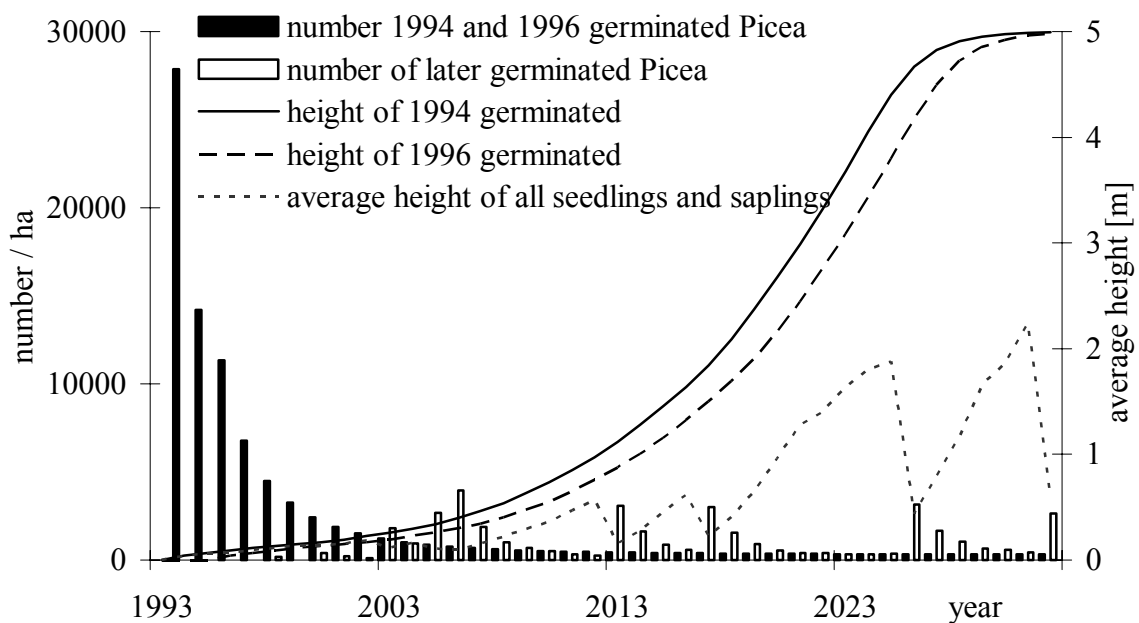

Fig. 13: Simulated numbers and average height of *Picea abies* for the montane level. Simulations were performed with microsite-specific germination, mortality and growth rates (gs-ms-rs, cf. Table 1), with the estimated browsing intensities (cf. Table 5) and the seed inputs described in the Appendix. Amounts and heights of the *Picea abies* saplings germinated in 1994 and 1996 were calculated in two separate simulation runs where only these cohorts germinated.

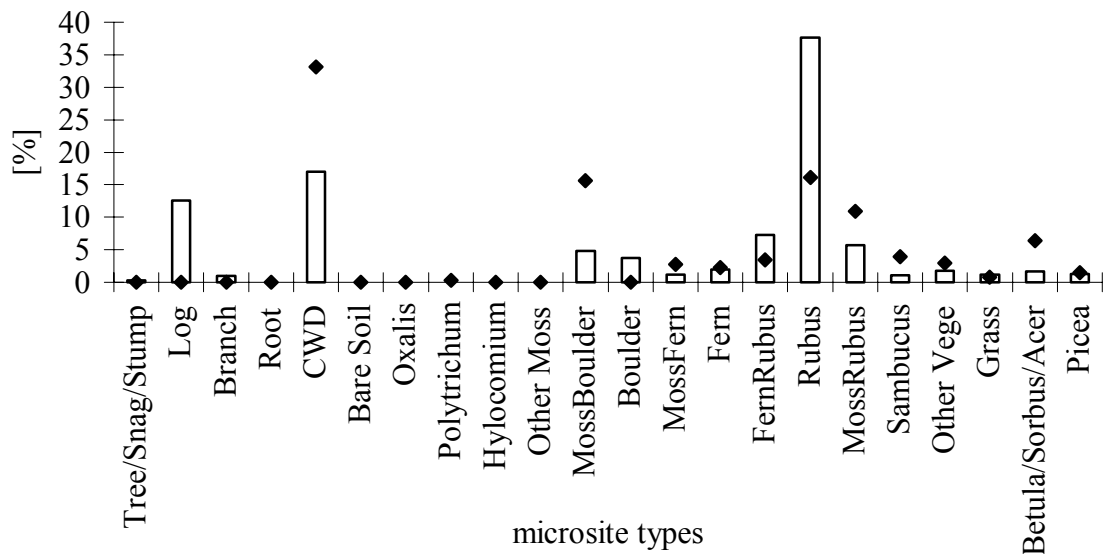

Fig. 14: Simulated typical future microsite composition on the montane level of the Gandberg in the year 2023. Bars represent the frequencies of microsite types, while diamonds show the frequency of *Picea* on each microsite type in percent of all *Picea* seedlings and saplings in height classes 1-5.

6.2.2 Subalpine level

Almost three times as many surviving *Picea* saplings of the cohorts that germinated in 1994 and 1996 were anticipated for the subalpine level (930 ha^{-1} , cf. Fig. 15) compared to the montane level (330 ha^{-1} , cf. Fig. 13). This can be explained by the fact that we assumed for the subalpine level (i) higher *Picea* seed inflows during mast years (max. $66'000 \text{ seeds ha}^{-1}$ on the subalpine level and $22'000 \text{ ha}^{-1}$ on the montane level), partial mast years ($9'000 \text{ seeds ha}^{-1}$ and $3'000 \text{ ha}^{-1}$) and all other years ($0-3'000 \text{ seeds ha}^{-1}$ and $0-1'000 \text{ ha}^{-1}$, cf. Appendix) due to the higher amount of surviving *Picea* seed trees and (ii) half as high browsing intensities in the height classes 2-5 than on the montane level (Table 5).

In contrast, our simulations for the subalpine level suggest that the microsite types 'Sorbus' or 'Acer' will be scarcer (0.9% of the area) than the microsite type 'Picea' (5.4%, cf. Fig. 16) 30 years after *Picea* die-back. This low amount of deciduous trees that will reach the height of 1.3 m is caused by (i) the assumed high browsing rates of ungulates on *Sorbus* and *Acer* (Table 5) and (ii) the assumed low seed inflows (cf. Appendix).

Microsite types such as 'Fern', 'MossFern', 'CWD', 'Log', 'Grass' and to a lesser extent also 'Polytrichum' will probably still dominate the subalpine level of the Gandberg forest, apart from the new *Picea* thickets (cf. bars in Fig. 16). Probably the

most favourable microsite types for tree regeneration will be ‘CWD’, ‘Polytrichum’ and ‘MossFern’ (cf. diamonds in Fig. 16).

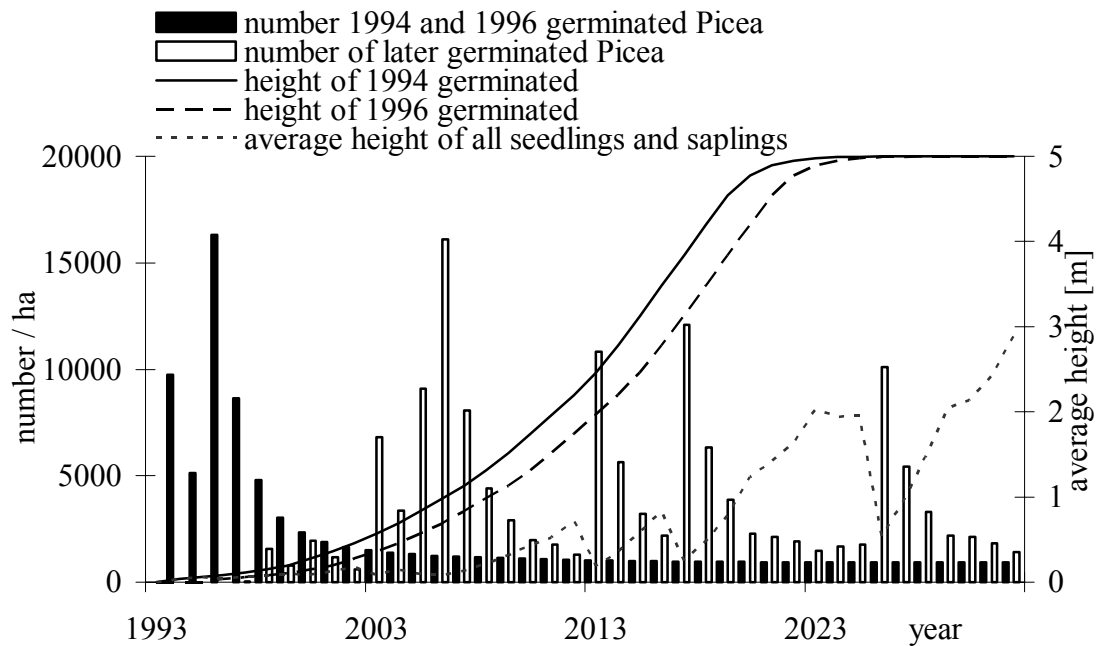

Fig. 15: Simulated numbers and average height of *Picea abies* for the subalpine level. Further explanations see Fig. 13.

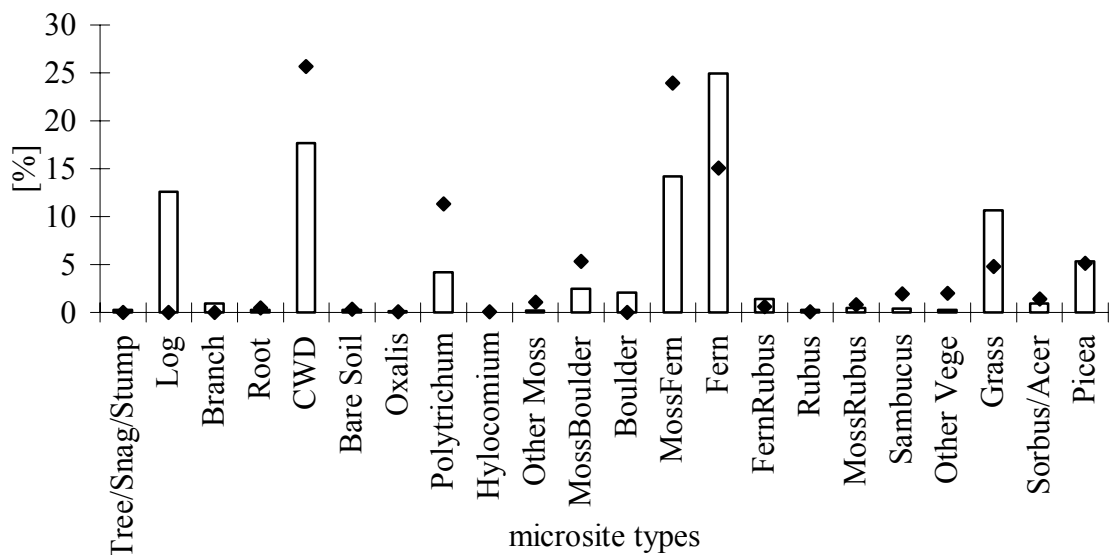

Fig. 16: Simulated typical future microsite composition on the subalpine level of the Gandberg in the year 2023. Bars represent the frequencies of microsite types, while diamonds show the frequency of *Picea* on each microsite type in percent of all *Picea* seedlings and saplings in height classes 1-5.

7. Discussion

We developed a new tree regeneration model for snag stands (so-called ‘RegSnag’, from ‘Regeneration in a Snag stand’) which considers microsite-specific differences in germination, mortality and growth rates. The model is based on the assumption that microsite types are crucial for explaining the establishment and viability of tree regeneration in mountain forests. This could be confirmed by comparing simulation outputs with independent field data. Simulations in which germination, mortality and growth rates were equal on all microsite types deviated to a much higher extent from the independent field data than simulations with microsite-specific rates. In particular, microsite-specific germination and mortality rates explained much of the difference between the amounts of tree regeneration on various microsite types (cf. Fig. 5 and 6), while microsite-specific height increments and mortality rates accounted mostly for the observed height distribution of *Picea* saplings (cf. Fig. 7 and 9). Therefore, we conclude that our model projected tree regeneration in the first 8 years after *Picea abies* die-back more accurately when microsite-specific rates were used. This was true for both the montane and subalpine levels.

Nevertheless, in reality the microsite-specific parameters probably differ more between the most ‘unfavourable’ and the most ‘favourable’ sites than we assumed in the model. The microsite ‘FernRubus’, to give only an extreme example, was assumed to be unfavourable for *Picea* regeneration, with low germination and growth rates and high mortality rates (cf. Table 1). Nonetheless, our simulation overestimated the amount of saplings on ‘FernRubus’ by a factor of about 3 on the montane level (cf. Fig. 5). This indicates that microsites are probably even more important than we assumed.

On the montane level, the most suitable sites for *Picea* establishment were ‘Root’, ‘Coarse Woody Debris’, moss cushions, and - surprisingly - ‘MossRubus’, whereas the most unfavourable sites were ‘Fern’, ‘FernRubus’ and ‘Rubus’ (cf. Fig. 5). While on the subalpine level ‘Root’ and ‘Coarse Woody Debris’ were also suitable sites, ‘Polytrichum’ and all sites dominated by ferns, raspberries and grasses were unfavourable (Fig. 6). It is likely that similar findings could have been obtained by merging some microsite types (e.g. ‘FernRubus’ and ‘Rubus’) in the tree regeneration model. Such a reduction in the number of microsites would simplify the model, but a grouping of microsite types must be made with care to maintain the necessary variability.

Obviously, a height-structured model of forest dynamics also has limits. In particular, the average height of the trees in a class was crucial in determining the transitions between the height classes in our ‘RegSnag’ model. Irregular seed input caused the average height of trees in a certain class to drop dramatically when saplings of a good seed year became part of this class. An opposite effect was found when saplings of a bad seed year became part of a class (cf. Fig. 13 and 15). Consequently,

this affected the transition probabilities because these probabilities increased sharply as average height approach maximum height (cf. equation 1). This made it difficult to predict the future height of trees. Nevertheless, we were able to circumvent this problem by simulating the development of isolated tree cohorts with our model (cf. Fig. 13 and 15).

A further limitation of such a model approach is that browsing by ungulates can only be integrated by reducing the growth rates of all trees in a given height class and not of individual trees (see section browsing intensity). In the case that browsing affects all individual trees similarly over time, e.g. if all trees are browsed twice during a certain time period, this general reduction in tree growth is not a problem. Instead of being browsed twice as strongly, each tree simply suffers a reduced terminal shoot loss every year. However, it would cause large deviations between reality and model simulations when ungulates browse some trees several times while they spare other ones. We have, however, no evidence that this should be the case in the Gandberg forest (Kupferschmid submitted).

It turned out during the simulations that our model was highly sensitive to the assumed browsing intensities (cf. Fig. 11). This poses a difficulty because little was known about the browsing intensities in the snag stands on the Gandberg. However, as the simulated numbers of trees in each height class were fairly close to the observed data from the Gandberg forest (Fig. 7 - 10), we suppose that the way in which we implemented the assumed browsing intensities reflected the conditions in the snag stands well. However, quantitative data would clearly improve the estimation of parameters and therefore the predictive power of the model.

Long term simulations together with the survey data from the Gandberg forest suggest that *Picea* regenerates rather quickly in these snag stands (e.g. Fig. 13 and 15), regardless of the high browsing intensities. For comparison, Eiberle and Nigg (1986) observed that heavily browsed *Picea* saplings required on average 22 years to reach the height of 1.3 m and thus to grow above the height chamois normally are able to browse. Generally, browsing often reduces height growth (Eiberle 1975), prolonging the phase where seedlings and saplings are susceptible to damage by further factors such as pathogenic fungi and snow pressure (cf. discussion in Ott *et al.* 1997). This indirectly reduces the number of tree saplings both in reality and in our model, in which they remain longer in the lower height classes that have higher mortality rates.

However, the most noticeable effect of heavy browsing is a change in the species composition due to a partial or even complete prevention of the establishment of certain species (e.g. Wasem and Senn 2000). In the former stands on the Gandberg, *Abies alba* and *Acer pseudoplatanus* were already scarce. In the future stands, they will probably be absent (*Abies*) or at least very rare (*Acer*) if browsing by ungulates continues at the present intensity. In contrast, *Betula pendula* quickly established after the *Picea* die-back. However, the density of *Betula* regeneration is much too low to form a pioneer

stand because the large snag stands probably minimized seed inflow (cf. limited long distance dispersal of *Betula*, Cameron 1996).

To conclude, microsite effects on tree regeneration in the snag stands in the Gandberg forest are extremely important, not only on the subalpine but also on the montane level. Our rather simple model approach showed that microsite types and microsite-specific effects on germination, mortality and height increment of trees should receive more attention when tree regeneration in mountain forests is modelled. This applies particularly in snag stands or other heavily disturbed sites, where light availability under a closed tree canopy is not limiting any more, but where competitive effects from ground vegetation and other site conditions become crucial for the growth and survival of tree regeneration.

Acknowledgement

We thank Marc Battaglia, Ulrich Wasem, Massimo Albisetti and the Forest Service of Schwanden for their valuable help during the fieldwork. This research was supported by the Foundation for the Advancement of Forest and Wood Research and the government of the canton Glarus.

8. References

- Abrazhko M.A. (1989): Growth characteristics of the Norway spruce understory in subclimax communities. *Bot. Zurn. Leningrad* **74**(6): 885-890.
- Ammer C. (1996): Konkurrenz um Licht zur Entwicklung der Naturverjüngung im Bergmischwald. *Forstl. Forschungsber. München* **158**: 198.
- Arnborg T. (1943): Granberget: En växtbiologisk undersökning av ett sydappländskt granskogsområde med särskilt hänsyn till skogstyper och foryngning (Granberget: A plant biological study of a spruce forest area in southern Lapland with particular reference to forest types and regeneration). *Norrl. Handbibl.* **14**: 282.
- Atkinson M.D. (1992): *Betula pendula* Roth (*B. verrucosa* Ehrh.) and *B. pubescens* Ehrh. *J. Ecol.* **80**(4): 837-870.
- Baker B.H. & Kemperman J.A. (1974): Spruce beetle effects on a white spruce stand in Alaska. *J. For.* **72**: 423-425.
- Bell F.W., Ter-Mikaelian M.T. & Wagner R.G. (2000): Relative competitiveness of nine early-successional boreal forest species associated with planted jack pine and black spruce seedlings. *Can. J. For. Res.* **30**(5): 790-800.
- Brang P. (1996a): Ansamungsgunst und Verteilung der Direktstrahlung in schlitzförmigen Bestandesöffnungen zwischenalpiner Fichtenwälder. *Schweiz. Z. Forstwes.* **147**(10): 761-784.
- Brang P. (1996b): Experimentelle Untersuchungen zur Ansamungsökologie der Fichte im zwischenalpiner Gebirgswald. *Beih. Schweiz. Z. Forstwes.* **77**: 1-375.

- Brang P. (1997): Ecological niches of seedling establishment in high-elevation forests. In: Chris Hollstedt & Alan Vyse (eds.), *Sicamous Creek Silvicultural Systems Project: Workshop Proceedings*. Research Branch, B.C. Ministry of Forests, Victoria, B.C, Kamloops, British Columbia, Canada. 144-153.
- Brang P., Schönenberger W., Ott E. & Gardner B. (2001): Forests as protection from natural hazards. In: Julian Evans (ed.) *The forest handbook*. Blackwell Science. 53-81.
- Bugmann H., Marti F. & Wallimann K. (1989): Auswirkungen eines Phosphorsäureesters (Insektizid Ekamet) auf die Planktonbiozönose des Greifensees. *Diplomarbeit*. Institut für Gewässerschutz und Wassertechnologie, Institut für Wald- und Holzforschung, ETH Zürich und EAWAG Dübendorf. 232 p.
- Burkart A. (2001): Einschätzung - Samenbehang. *interner Bericht*, Eid. Forschungsanstalt WSL, Birmensdorf. 8 p.
- Camaret S. (1997): Rôle des perturbations dans la dynamique des pessières d'altitude. Impact d'ouvertures artificielles et naturelles sur la régénération et le développement d'un peuplement forestier. *Thèse de doctorat*. Université de Savoie, Chambéry. 264 p.
- Cameron A.D. (1996): Managing birch woodlands for the production of quality timber. *Forestry* **69**(4): 357-371.
- Cavegn D. (1996): Zusammenhänge zwischen Vegetationsentwicklung und Fichtenansamung in kleinen Lücken im subalpinen Fichtenwald bei Sedrun. *Diplomarbeit*. Departement Forstwissenschaften, ETH, Zürich. 71 p.
- Chauvin C., Renaud J.-P., Rupé C. & Leclerc D. (1994): Stabilité et gestion des forêts de protection. *Bull. tech.* **27**(27): 37-52.
- Eiberle K. (1975): Ergebnisse einer Simulation des Wildverbisses durch den Tribschnitt. *Schweiz. Z. Forstwes.* **126**: 821-839.
- Eiberle K. & Nigg H. (1986): Untersuchung über den Verbiss durch die Gemse (*Rupicapra rupicapra* L.) an Fichte (*Picea abies*). *Ber. Bot.-Zool. Ges. Liecht.-Sargans-Werdenberg* **15**: 15-36.
- Eichrodt R. (1969): Über die Bedeutung von Moderholz für die natürliche Verjüngung im subalpinen Fichtenwald. *Beih. Z. Schweiz. Forstver.* **45**: 122.
- Fischer A. & Jehl H. (1999): Vegetationsentwicklung auf Strumwurfflächen im Nationalpark Bayerischer Wald aus dem Jahre 1983. *Forstl. Forsch.ber. München* **176**: 93-101.
- Frehner M. (2000): Untersuchungen über den Einfluss unterschiedlicher Kleinstandorte und der Pflanztechnik auf Fichtenpflanzungen in subalpinen Lawinenschutzwäldern. *Beih. Schweiz. Z. Forstwes.* **92**.
- Hanssen K.H. (2002): Effects of seedbed substrates on regeneration of *Picea abies* from seeds. *Scand. J. For. Res.* **17**(6): 511-521.
- Harmon M.E. (1989): Retention of needles and seeds on logs in *Picea sitchensis* - *Tsuga heterophylla* forests of coastal Oregon and Washington. *Can. J. Bot.* **67**: 1833-1837.
- Harmon M.E., Franklin J.F., Swanson F.W., Sollins P., Gregory S.V., Lattin J.D., Anderson N.H., Cline S.P., Aumen N.G., Sedell J.R., Lienkaemper G.W., Cromack K., Cromack J. & Cummins K.W. (1986): Ecology of coarse woody debris in temperate ecosystems. *Adv. Ecol. Res.* **15**: 133-302.

- Hasenauer H., Stampfer E., Rohrmoser C. & Sterba H. (1994): Solitårdimensionen der wichtigsten Baumarten Österreichs. *Österr. Forstztg.* **105**(3): 28-29.
- Hesselman H. (1939): Granens förnygringssvårigheter på örtrik mark och dess orsaker (Difficulties and their causes in the regeneration of Norway Spruce on sites with a rich herbaceous ground flora). *Bot. Notiser:* 413-422.
- Heurich M. (2001): Waldentwicklung im montanen Fichtenwald nach grossflächigem Buchdruckerbefall im Nationalpark Bayerischer Wald. In: Heurich (ed.) *Waldentwicklung im Bergwald nach Windwurf und Borkenkäferbefall*. Nationalparkverwaltung Bayerischer Wald, Grafenau. 99-176.
- High Performance Systems Inc. (2001): Stella Research Software. Hanover.
- Holeksa J. (1998): Rozpad drzewostanu i odnowienie swierka a struktura i dynamika karpackiego boru gornoreglowego (Breakdown of tree stand and spruce regeneration versus structure and dynamics of a Carpathian subalpine spruce forest). *Monogr. Bot.* **82**: 1-201 (english summary 201-209).
- Hörnberg G., Ohlson M. & Zackrisson O. (1997): Influence of bryophytes and microrelief conditions on *Picea abies* seed regeneration patterns in boreal old-growth swamp forests. *Can. J. For. Res.* **27**: 1015-1023.
- Hytteborn H. & Packham J.R. (1987): Decay rate of *Picea abies* logs and the storm gap theory: a re-examination of Sernander plot III, Fiby Urskog, central Sweden. *Arboric. J.* **11**: 299-311.
- Ishizuka M., Toyooka H., Osawa A., Kushima H., Kanazawa Y. & Sato A. (1998): Secondary succession following catastrophic windthrow in a boreal forest in Hokkaido, Japan: The timing of tree establishment. *J. Sust. For.* **6**(3/4): 367-388.
- Jäderlund A., Zackrisson O. & Nilsson M.-C. (1996): Effects of bilberry *Vaccinium myrtillus* L. litter on seed germination and early seedling growth of four boreal tree species. *J. Chem. Ecol.* **22**: 973-986.
- Jobidon R. (1994): Light threshold for optimal balck spruce (*Picea mariana*) seedling growth and development under brush competition. *Can. J. For. Res.* **24**(8): 1629-1635.
- Jogiste K., Vares A. & Sendros M. (2003): Restoration of former agricultural fields in Estonia: comparative growth of planted and naturally regenerated birch. *Forestry* **76**(2): 209-219.
- Karlsson A. (1996): Initial seedling emergence of hairy birch and silver birch on abandoned fields following different site preparation regimes. *New Forests* **11**(2): 93-123.
- Kinnaird J.W. (1974): Effect of site conditions on regeneration of birch (*Betula pendula* Roth and *Betula pubescens* Ehrh). *J. Ecol.* **62**(2): 467-472.
- Kooijman A.M., Emmer I.M., Fanta J. & Sevink J. (2000): Natural regeneration potential of the degraded Krkonose forests. *Land. Degrad. Dev.* **11**(5): 459-473.
- Kupferschmid A.D. (2002): Bark influence on vegetation development in a dead *Picea abies* mountain forest. In: Roberta Bottarin & Ulrike Tappeiner (eds.), *Interdisciplinary mountain research*. Blackwell Science, Berlin. 242-247.
- Kupferschmid A.D., Schönenberger W. & Wasem U. (2002): Tree regeneration in a Norway spruce snag stand after tree die-back caused by *Ips typographus*. *For. Snow Landsc. Res.* **77**(1/2): 149-160.
- Kupferschmid A.D. & Bugmann H. (submitted): Predicting decay and vegetation development in *Picea abies* snag stands. *Plant Ecol.*

- Kupferschmid A.D. (submitted): Effect of microsites and logs on the impact of ungulates on *Picea abies* regeneration. *For. Ecol. Manage.*
- Kupferschmid Albisetti A.D. (in prep.): Succession in a protection forest after *Picea abies* die-back. *PhD thesis*. Department of Forest Sciences, ETH, Zürich.
- Kupferschmid Albisetti A.D., Brang P., Schönenberger W. & Bugmann H. (2003): Decay of *Picea abies* snag stands on steep mountain slopes. *For. Chron.* **79**(2): 247-252.
- Küssner R., Reynolds P.E. & Bell F.W. (2000): Growth response of *Picea mariana* seedlings to competition for radiation. *Scand. J. For. Res.* **15**(3): 334-342.
- Kuuluvainen T. & Juntunen P. (1998): Seedling establishment in relation to microhabitat variation in a windthrow gap in a boreal *Pinus sylvestris* forest. *J. Veg. Sci.* **9**: 551-562.
- Lauber K. & Wagner G. (1996): *Flora Helvetica*. Verlag Paul Haupt, Bern.
- Lüscher F. (1990): Untersuchungen zur Höhenentwicklung der Fichtennaturverjüngung im inneralpinen Gebirgswald. *Dissertation*. Professur Waldbau, Departement Forstwissenschaften, ETH, Zürich. 138 p.
- Mayer H. (1960): Bodenvegetation und Naturverjüngung von Tanne und Fichte in einem Allgäuer Plenterbestand. *Ber. Geobot. Inst. ETH Stift. Rübel* **31**: 19-24.
- Mencuccini M., Piussi P. & Zanzi Sulli A. (1995): Thirty years of seed production in a subalpine Norway spruce forest: Patterns of temporal and spatial variation. *For. Ecol. Manage.* **76**: 109-125.
- Mössmer E. (1998): Ohne Schutzwald geht's bergab! *Allg. Forstztg.* (21): 1284-1285.
- Motta R., Brang P., Frehner M. & Ott E. (1994): Copertura muscinale e rinnovazione di abete rosso (*Picea abies* L.) nella pecceta subalpina di Sedrun (Grigioni, Svizzera). *Monti e Boschi* **45**(3): 49-56.
- Nilsson U., Gemmel P., Johansson U., Karlsson M. & Welander T. (2002): Natural regeneration of Norway spruce, Scots pine and birch under Norway spruce shelterwoods of varying densities on a mesic-dry site in southern Sweden. *For. Ecol. Manage.* **161**(1-3): 133-145.
- Nüsslein S. & Faisst G. (1998): *Waldentwicklung im Nationalpark Bayerischer Wald 1998: Totholzflächen und Waldverjüngung*. Bayerische Landesanstalt für Wald und Forstwirtschaft, Freising. 25 p.
- Ott E., Frehner M., Frey H.-U. & Lüscher P. (1997): *Gebirgsnadelwälder: Ein praxisorientierter Leitfaden für eine standortgerechte Waldbehandlung*. Verlag Paul Haupt, Bern, Stuttgart, Wien. 287 p.
- Ott E., Lüscher F., Frehner M. & Brang P. (1991): Verjüngungsökologische Besonderheiten im Gebirgsfichtenwald im Vergleich zur Bergwaldstufe. *Schweiz. Z. Forstwes.* **142**(11): 879-904.
- Parker W.C., Watson S.R. & Cairns D.W. (1997): The role of hair-cap mosses (*Polytrichum spp.*) in natural regeneration of white spruce (*Picea glauca* (Moench) Voss). *For. Ecol. Manage.* **92**: 19-28.
- Pellissier F. (1993): Allelopathic inhibition of spruce germination. *Acta Oecol.* **14**(2): 211-218.
- Rebane K.K. (1975): Effect of leaf litter of birch, aspen and hazel on the occurrence and survival of seedlings of *Picea abies*. *Lesovedenie* (1): 64-72.
- Reif A. & Przybilla M. (1995): Zur Regeneration der Fichte (*Picea abies*) in den Hochlagen des Nationalparks Bayerischer Wald. *Hoppea* **56**: 467-514.

- Ricard J.-P. & Messier C. (1996): Abundance, growth and allometry of red raspberry (*Rubus idaeus* L.) along a natural light gradient in a northern hardwood forest. *For. Ecol. Manage.* **81**(1): 153-160.
- Roth I. (1996): Untersuchungen über die forstliche Ansamung in einem abgestorbenen Fichtenbestand, Objekt: Gandberg oberhalb Schwanden GL. *Diplomarbeit*. Departement Wald- und Holzforschung, ETH, Zürich. 99 p.
- Rüegg D. & Schwitter R. (2002): Untersuchungen über die Entwicklung der Verjüngung und des Verbisses im Vivian-Sturmgebiet Pfäfers. *Schweiz. Z. Forstwes.* **135**(4): 130-139.
- Schmid J.M. & Frye R.H. (1977): Spruce beetle in the Rockies. *U.S. Dep. Agric. For. Serv. Gen. Tech. Rep. RM 49*: 1-38.
- Schmidt A. (1983): *Der Freiberg Kärpf; Das älteste Wildschutzgebiet der Schweiz in den Glarner Alpen*. Buchhandlung Baeschlin, Glarus.
- Schönenberger W. (2000): Silvicultural problems in subalpine forests in the Alps. In: M.F. Price & N. Butt (eds.), *Forests in sustainable mountain development: a state of knowledge report for 2000*. CABI Publishing. 197-203.
- Schönenberger W. (2002): Post windthrow stand regeneration in Swiss mountain forests: the first ten years after the 1990 storm Vivian. *For. Snow Landsc. Res.* **77**(1/2): 61-80.
- Starostina K.F. (1965): Experimental data on the effect of *Rubus idaeus* on the growth of *Picea abies* seedlings on clear fellings. *Bot. Zhurn. Leningrad* **50**(7): 971-974.
- Szewczyk J. & Szwargrzyk J. (1996): Tree regeneration on rotten wood and on soil in old-growth stand. *Vegetatio* **86**(122): 37-46.
- Tan B.S. & Bruckert S. (1992): Effect of physical environmental factors on the initial stages of the natural regeneration of fir (*Abies alba*) at some sites in the Jura. *Ann. Sci. For.* **49**(4): 337-349.
- Truninger K. & Bucher S. (1994): Untersuchungen zur Fichtenverjüngung in einem subalpinen Vogelbeervorwald. *Semesterarbeit*, Abteilung Umweltnaturwissenschaften, ETH, Zürich. 45 p.
- Ulanova N.G. (2000a): The effects of windthrow on forests at different spatial scales: a review. *For. Ecol. Manage.* **135**: 155-167.
- Ulanova N.G. (2000b): Plant age stages during succession in woodland clearings in Central Russia. *Proceedings IAVS Symposium*. I.A.V.S. Opulus Press Uppsala, Schweden. 80-83.
- Wagnière S. (1996): Einfluss eines Birkenvorwaldes auf eine Schlusswaldsukzession bei Sedrun (GR). *Diplomarbeit*. Professur für Waldbau, Departement Forstwissenschaften, ETH, Zürich.
- Walcher J. & Kupferschmid A.D. (2001): Borkenkäfer-Schadenflächen bei Schwanden. In: Thomas Rageth (ed.) *Binding Preis für vorbildliche Waldpflege 2001: Vivian als Chance. Gemeinde Schwanden GL*. Sophie und Karl Binding Stiftung, Basel. 43-45.
- Wasem U. & Senn J. (2000): Fehlende Weisstannenverjüngung: Hohe Schalenwildbestände können die Ursache sein. *Wald Holz* **9**: 11-14.
- Wunder J. (2002): Naturverjüngung in schlitzförmigen Bestandesöffnungen. Erfolgskontrolle in hochmontanen und subalpinen Schutzwäldern des Vorderreintales, Graubünden. *Diplomarbeit*. Universität Bayreuth. 67 p.

9. Appendix: Details of model parameterisation

We assumed that saplings in a ‘very unfavourable’ habitat had only 50% of the average germination rate and average height increment; saplings in an ‘unfavourable’ habitat 75%; saplings in a ‘favourable’ site 125%; and finally saplings in a ‘very favourable’ site 150% (Table 1 and 2). In contrast, mortality rates were highest in ‘very unfavourable’ sites (150%) and lowest in ‘very favourable’ sites (50%).

9.1 *Picea abies*

9.1.1 Seed availability

Based on the mean germination and seedling mortality rates (m_0 , Table 1) and the germination data from the permanent plots (Fig. 2), we calculated the approximate seed rain for each year (cf. equation 3). In addition, information about the magnitude of seed years (cf. Burkart 2001) was taken into account. In the winter 1993/1994, when the first *Picea* trees died, many *Picea* seeds were produced on the montane level of the Gandberg (about 3 seedlings m^{-2} in 1994, Fig. 2), even though this was not a mast year in the region (cf. Burkart 2001). Therefore in our model for the montane level, we assumed an exceptional fructification (some authors would call this a ‘fear fructification’) at the end of 1993, with about 140’000 *Picea* seeds ha^{-1} . Afterwards, seed availability of *Picea* probably decreased dramatically due to the almost complete die-back of *Picea*. Hence, only about 22’000 seeds ha^{-1} were present after the mast year 1995, and probably even less after the partial mast years 1997 and 1999 (we assumed ca. 3’000 seeds $ha^{-1}yr^{-1}$). In all other years until 2001, a random number between 0-1’000 seeds $ha^{-1}yr^{-1}$ was assumed.

After 2001, we assumed that on average every fifth year is a *Picea* mast year at the montane level. To implement this in the model, a random variable ‘mast year’ was introduced, which took with 20% probability the value 1, equal to a mast year, otherwise 0 (Monte Carlo procedure in the software STELLA®). When a *Picea* mast year occurred, we assumed a uniformly distributed random number of viable *Picea* seeds (Random procedure in STELLA®) between 10’000-22’000 seeds $ha^{-1}yr^{-1}$, otherwise about 0-1’000 seeds $ha^{-1}yr^{-1}$, as was done until 2001.

We assumed the same number of *Picea* seeds for the entire montane Gandberg forest, regardless of the distance of the adjacent green forest (minimum 50 m), because counting seeds on the snow surface in winter 2001 showed a uniform seed distribution (Kupferschmid, unpublished). However, we assumed that seed production on the two levels was not identical. Firstly, there were more living trees in the neighbourhood of snag stands on the montane level in winter 1993 than on the subalpine level (which borders to alpine meadows, a large avalanche track and the montane snag stands) and therefore the montane stands probably had more seeds during the exceptional seed year 1993. Secondly, more groups of *Picea* trees survived, scattered throughout the

subalpine level, during the good seed years 1995, 1997 and 1999. Thirdly, mast years decrease with elevation (Mencuccini *et al.* 1995). We assumed therefore only about 46'000 seeds ha⁻¹ at the end of 1993, but 66'000 seeds ha⁻¹yr⁻¹ in mast years (e.g. 1995) and 9'000 seeds ha⁻¹yr⁻¹ in partial mast years (e.g. 1997 and 1999), otherwise a random number between 0 and 3'000 seeds ha⁻¹yr⁻¹. For the future, we assumed one full or partial mast year in seven years.

9.1.2 Germination

According to a literature review, we estimated microsite-specific germination rates of *Picea* (cf. Table 1). Generally, we assumed the same effects of competing vegetation on *Picea* regeneration in our snag stands as in green forests or clear-cuts. More *Picea* seeds were found to germinate on coarse woody debris ('CWD'), roots and boulders than on bare soil (Hytteborn and Packham 1987, Szewczyk and Szwarzgrzyk 1996). Compared with mineral soil, germination of *Picea* was very low on the microsite type 'Grass' (Brang 1996b, Hanssen 2002) and small on the microsite type 'Oxalis' (Hesselman 1939, Brang 1996b). However, germination success was comparable with mineral soil in the microsite type 'Other Vegetation', which was composed of *Vaccinium myrtillus* (Pellissier 1993, Brang 1996b) or *Senecio ovatus* (Tan and Bruckert 1992). The moss *Polytrichum* has been reported to either negatively affect *Picea* germination (e.g. in the case of very dense living cushions, Brang 1996b), or to be rather favourable, in particular when the cushions were not very dense (e.g. Motta *et al.* 1994, Hörnberg *et al.* 1997). We therefore assumed an average germination rate for the Gandberg forest. *Hylocomium splendens* and *Thuidium tamariscinum* (i.e. microsite type 'Hylocomium') are probably more successful in inhibiting tree regeneration than the microsite type 'Polytrichum' or 'Other Moss' (liverworts or *Sphagnum*), because of the horizontal growth habit of the first (Arnborg 1943, Hörnberg *et al.* 1997), at least when the moss cover is very dense (Motta *et al.* 1994). 'Other Moss' were assumed to be favourable for *Picea* germination, due to their potential to store both water and seeds (e.g. Harmon 1989, Motta *et al.* 1994, Hörnberg *et al.* 1997). The microsite types 'Ferns' (i.e. *Dryopteris*), 'MossFern' and 'MossRubus' were found to be as suitable if not more suitable substrates for the germination of *Picea* than *Polytrichum* (Holeksa 1998). In contrast, the microsite types 'Rubus' and 'FernRubus' seemed to inhibit *Picea* germination, as in the permanent plots hardly any new *Picea* seedlings were found after the partial mast years of 1997 and 1999 (Fig. 2, information about mast years cf. Burkart 2001).

When the soil surface is partly covered by leaves of deciduous trees, germination of *Picea* is more frequent than without leaf litter (Rebane 1975). In particular, germination of *Picea* was reported to be rather good under pioneer crops of *Betula* (Rebane 1975, Wagnière 1996) and *Sorbus* (Truninger and Bucher 1994). In the model,

similar good emergence was assumed under *Acer*. In contrast, germination was assumed to be lower under *Picea* thickets (i.e. *Picea* saplings >1.3 m; microsite type 'Picea' in the microsite type module).

9.1.3 Mortality

Mortality rates were estimated based on a literature survey and from the data of the permanent plots at the montane level, where on average about 25% of the *Picea* seedlings and saplings died each year during the first 8 years (Fig. 4 in Kupferschmid *et al.* 2002). Normally, mortality rates decrease with increasing height or age of tree saplings. The rather constant mortality rate on the Gandberg forest was probably due to the change in microsite types from 'Bare soil' to moss cushions and finally to 'Rubus' or 'FernRubus'. A dense cover of *Rubus idaeus* has been found to seriously reduce survival and vigour of spruce seedlings (e.g. Starostina 1965), but some survival was still possible (cf. permanent plot data and e.g. Mayer 1960, Cavegn 1996). We assumed that mortality in the microsite types 'MossFern' and 'MossRubus' is lower than in 'Fern' or 'Rubus', because more light is available in the types with mosses, and Starostina (1965) found that competition for light and not for water and nutrients dominates the competitive interactions between tree regeneration and ground vegetation.

Compared with mineral soil, survival of seedlings was very low in the microsite type 'Grass', and low in the microsite types 'Polytrichum', 'Other Moss', 'Oxalis', and 'Other Vegetation' (when composed of *Vaccinium myrtillus*, cf. Brang 1996b, Cavegn 1996, Jäderlund *et al.* 1996). Especially for sites with *Calamagrostis* or *Vaccinium*, these low survival rates were assumed to apply also for small saplings (Holeksa 1998), but not for taller saplings (i.e. at least saplings taller than the grasses, e.g. Hanssen 2002). 'Polytrichum' and all other moss types were assumed not to negatively influence *Picea* saplings of higher classes (e.g. no smothering of taller saplings by mosses, Camaret 1997, Hörnberg *et al.* 1997, Parker *et al.* 1997). We were unable to find any exact information on the mortality rates of *Picea* in the microsite types 'Sambucus', 'Betula', 'Sorbus' and 'Acer'. However, regeneration was reported to be fairly good under pioneer tree crops, and hence we assumed a mean mortality rate for the smaller classes, and a small mortality rate for the higher classes (Table 1).

Mortality on 'Coarse Woody Debris' and 'Roots' has often been reported to be very small for seedlings, but only small for saplings (Eichrodt 1969, Szewczyk and Szwargrzyk 1996). However, we supposed that one of the major advantages of these microsite types - the reduced competition from the ground vegetation - applies only for the subalpine level and not for the montane level, where roots and rotten logs were often covered by vegetation, mostly by *Rubus* and *Sambucus*. We therefore assumed different mortality rates for the two elevational levels (Table 1).

Even though in literature the microsite type ‘MossBoulder’ is often described as being very favourable for tree regeneration (e.g. Reif and Pyrzbill), we assumed a rather high mortality rate for seedlings and small saplings, due to the low amount of substrate for *Picea* roots on boulders (Table 1).

9.1.4 Height increment

Based on a literature survey, the microsite-specific height increments were estimated for each species and height class around the mean values that were derived from the randomly sampled trees in the Gandberg forest (cf. section 3.3.2). Generally, the higher the vegetation competition, the less light is available for tree seedlings and saplings, and the smaller are the height increments (Abrazhko 1989, Jobidon 1994) or at least the smaller the diameter increments of the tree saplings (Bell *et al.* 2000, Küssner *et al.* 2000). In particular, we assumed *Picea* saplings in the microsite types ‘FernRubus’ and ‘Rubus’ to grow more slowly than saplings in the microsite types ‘MossRubus’, where *Rubus idaeus* was much less dense. Likewise, *Picea* on the microsite types ‘Other Vegetation’ (when composed of *Senecio ovatus*) and ‘Fern’ were assumed to grow more slowly than in ‘Other Vegetation’ (when dominated by *Vaccinium myrtillus*, Frehner 2000). However, saplings in the microsite type ‘Grass’ (i.e. *Calamagrostis villosa*) were assumed to grow as well as in the microsite type ‘Bare Soil’. In addition, *Picea* sapling growth under *Sambucus*, *Sorbus* and *Betula* crops was assumed to be good (Truninger and Bucher 1994), except for saplings larger than 80 cm under *Betula* (Wagnière 1996). Furthermore, we assumed no difference in height increment between the microsite types ‘Bare Soil’ and ‘MossBoulder’ for the small height classes (Hytteborn and Packham 1987). However, saplings in larger height classes probably grow less well on ‘MossBoulder’, due to the low amount of available substrate. For the seedlings and very small saplings, we assumed a slightly smaller height increment in the microsite type ‘Oxalis’ (Brang 1996b) than on ‘Bare Soil’. In contrast, *Picea* seedlings and small saplings on the microsite type ‘Other Moss’ (mosses such as *Sphagnum*) were assumed to grow slightly better than on the other moss microsite types, since these mosses colonise sites with a higher moisture content. Finally, small height increments were also assumed for the microsite types ‘Coarse Woody Debris’ and ‘Root’ because wood has lower concentrations of the nutrients required for plant growth than most mineral or other organic substrates (Eichrodt 1969, Harmon *et al.* 1986).

9.2 *Betula pendula*

9.2.1 Seed availability

We assumed that good seed years of *Betula* occur irregularly, rather than continuously (e.g. Atkinson 1992). We derived the annual numbers of seeds by dividing the germination data in the permanent plots on the Gandberg (Fig. 2) by the average germination rate of 0.4 and 1 minus the mortality rate $m_0 = 0.1$ (cf. equation 3). This resulted in 0.7'000 seeds $\text{ha}^{-1}\text{yr}^{-1}$ during the first 8 years after *Picea* die-back. According to personal observations, the permanent plots clearly contained higher numbers of *Betula* saplings than stands on the montane level on average. Therefore we performed simulations with only about 5% of this seed inflow, i.e. random seed numbers between 0 and 350 $\text{ha}^{-1}\text{yr}^{-1}$ (cf. Fig. 8).

No fructifying *Betula* trees were found on the subalpine level. Seed dispersal of birch was found to decline exponentially with distance from seed source (Cameron 1996). We therefore assumed no *Betula* seeds on the subalpine level of the Gandberg forest.

9.2.2 Germination

In contrast to *Picea*, we found almost no germination rates of *Betula* in the literature (except a very low value in Nilsson *et al.* 2002). However, we assumed *Betula* to germinate on average more abundantly than *Picea* in open sites (Table 2).

Germination was found to be highest in open sites, in particular on bare mineral soil (Karlsson 1996), bare humus soil or dense cushions of *Sphagnum* (Kinnaird 1974). In addition, Kinnaird (1974) found only some seedlings on other mosses, litter, wood and dung, but almost no seedlings on sites dominated by grasses, herbs, ferns, dwarf shrubs (*Calluna*, *Vaccinium*), lichens and rocks. Generally, successful birch establishment requires a vegetation-free substrate where the seedling is not subject to frost or to summer drought (reviews see e.g. Atkinson 1992, Cameron 1996). In contrast to *Picea*, germination on coarse woody debris is probably small, and almost absent on roots; notably, several authors found *Betula* seedlings in windthrow areas mostly on tree mounds and pits, but almost none on rotten wood (e.g. Kuuluvainen and Juntunen 1998, Ulanova 2000a). Furthermore, often there is a lack of birch regeneration within birchwoods (Kinnaird 1974), reflecting the low shade tolerance of this species.

9.2.3 Mortality

Again, we assumed that *Betula* survives on average better than *Picea* in open sites (e.g. almost no birch mortality was found by Nilsson *et al.* 2002). Birch mortality rates (Table 2) are hence lower than *Picea* mortality rates (Table 1).

Birch saplings were found to be more sparse under tree cover than in grasslands (e.g. Kinnaird 1974), and lower survival of birch saplings was related to increased shelterwood density (Nilsson *et al.* 2002). Cameron (1996) summarised that birch saplings must be taller than the competing vegetation to survive. However, seedlings are probably more tolerant to shade than saplings (e.g. Kinnaird 1974), and we therefore assumed slightly higher survival rates for birch seedlings (Table 2). Furthermore, Cameron (1996) pointed out that more birch saplings survive on mineral soil than on litter or mosses. Some authors report a lower mortality of *Betula* saplings compared with *Picea* saplings in the microsite type ‘Grass’ (Ishizuka *et al.* 1998, Kooijman *et al.* 2000, Ulanova 2000b). In addition, survival is probably not impossible within *Rubus* because *Betula* saplings often replace a *Rubus* brushwood (e.g. in windthrow sites, Fischer and Jehl 1999).

9.2.4 Height increment

In contrast to *Picea*, we found almost no information about microsite-specific height increments of *Betula* in the literature. We therefore estimated all height increments of *Betula* according to the following information: Birch saplings probably grow more slowly when shaded compared to open sites (Cameron 1996). Nevertheless, height increment cannot be very slow under *Rubus idaeus* because *Betula* usually overtopped *Rubus* quickly (e.g. Ricard and Messier 1996, Ulanova 2000b).

9.3 *Sorbus aucuparia*

We assumed that *Sorbus* and *Betula* have similar germination and mortality rates on the Gandberg forest in the absence of ungulates (Table 2 and 3). As mentioned in the section parameterisation, height increment of unbrowsed *Sorbus* was assumed to be similar to that in windthrow areas (Schönenberger 2002). Hence, we assumed *Sorbus* to grow slightly faster than *Picea* in height classes 1-5, but more slowly in height class 7 (Table 3; Schönenberger unpublished). Again, we assume that height increment is 10% lower on the subalpine than on the montane level.

Based on the permanent plot data (Fig. 2), Table 3 and equation 3, we assumed irregular annual seed production between 0-500 seeds $\text{ha}^{-1}\text{yr}^{-1}$ for the montane level. However, we implemented an extraordinary good seed year with 8'000 *Sorbus* seeds ha^{-1} for 1993 (as for *Picea*). According to the mixture of surviving trees on the Gandberg forest, we assumed about 4 times as many *Sorbus* seeds on the subalpine than on the montane level (0-20 seeds $\text{ha}^{-1}\text{yr}^{-1}$), except for about twice the number of seeds during the extraordinary good seed year in 1993 (i.e. 160 seeds ha^{-1}).

9.4 *Acer pseudoplatanus*

We assumed *Acer* seeds to have a higher germination rate (g) and *Acer* seedlings to have a smaller mortality rate (m_0) than *Sorbus* and *Betula* seedlings because the seeds of *Acer* are larger (cf. Table 4). According to Ammer (1996), mortality of maple saplings was less than 10% during more than one decade in clear-cuts, but up to 90% in closed stands of a mixed mountain forest. We therefore assumed also very low mortality rates for *Acer* saplings in the snag stands on the Gandberg (Table 4). However, it is clear that these low mortality rates are only valid in the absence of browsing (see section browsing intensity).

As mentioned in the section parameterisation, height increment of unbrowsed *Acer* saplings was assumed to be similar to those in the windthrow areas (Schönenberger 2002). Hence, we assumed *Acer* saplings to grow similar to those of *Picea* saplings in height classes 1-3, but faster in height classes 4-7 (Table 4; Schönenberger unpublished). Again, we assume that height increment is 10% lower on the subalpine than on the montane level.

Based on the permanent plots (Fig. 2), Table 4 and equation 3, we calculated an irregular seed production between 0-8'000 seeds $\text{ha}^{-1}\text{yr}^{-1}$ for the montane level. However, according to personal observations, there were about twice as many fructifying *Acer* trees in the surroundings of the permanent plots than on the montane level on average. Therefore we simulated also with only about 50% of this seed inflow, i.e. random seed numbers between 0 and 4'000 $\text{ha}^{-1}\text{yr}^{-1}$ (cf. Fig. 8). According to the mixture of surviving trees on the Gandberg forest, we assumed the seed rain on the subalpine level to amount to only 1/8 of the seed rain on the montane level, hence about 0-500 seeds $\text{ha}^{-1}\text{yr}^{-1}$.

V DISCUSSION AND CONCLUSIONS

As far as the short-term succession is concerned, I refer the reader to the chapters III A-C. There, the questions listed at the beginning of the present thesis about the decay process, ground-vegetation succession and tree regeneration are answered. Here, I will discuss only those aspects that are relevant for assessing the protective effect of the snag stands in the Gandberg forest. In particular, I consider the protective effect provided by (i) snags, stumps and logs and (ii) by the new tree regeneration. Then, these effects are considered simultaneously to draw a conclusion about the total protective effect provided by the entire snag stands on the Gandberg.

As the conclusions about the long-term succession are mainly based on the newly developed model ‘RegSnag’, I will first summarise the key aspects of the model.

V A The model ‘RegSnag’

The simulation model ‘RegSnag’ (‘Regeneration in a Snag stand’), which was developed during this thesis, accurately predicted the frequencies of the microsite-types found in the snag stands in the Gandberg forest 8 years after *Picea* die-back (chapter IV B). Furthermore, the simulated density and height distribution of *Picea abies*, *Betula pendula*, *Acer pseudoplatanus* and *Sorbus aucuparia* saplings also closely matched survey data from the Gandberg forest. Moreover, the distribution of *Picea* across the microsite types was predicted well for the year 2001 (chapter IV C).

However, sensitivity analyses were only carried out for selected parameters, such as the transition probability from the microsite type ‘Polytrichum’ into ‘Grass’ (cf. chapter IV B) or for the browsing intensity on *Picea* saplings (cf. chapter IV C). The high numbers of parameters impede a sensitivity analysis of all parameters. Anyhow, the eight simulation scenarios with microsite-specific or average rates for germination, mortality and height increment (chapter IV C) tested the main assumptions of the model. In particular, these simulation runs revealed that the use of microsite-specific parameters improved the prediction accuracy of the tree regeneration model in the snag stands in the Gandberg forest. In addition, the simulations helped to elucidate the key elements that are generally important for the development of tree regeneration in a snag stand and that should be more often considered simultaneously in simulation models. Those are (i) microsite-specific rates of germination, growth and mortality, (ii) browsing intensity, and (iii) seed availability.

In spite of these findings, it is probably difficult to use the model ‘RegSnag’ one-to-one for projecting the succession in other snag stands, mostly because (i) the future direction of the vegetation development has to be known (i.e. raspberry or fern and grass dominance), (ii) the model is very sensitive to the browsing intensities assumed, and (iii) continuous, more or less irregular seed years constitute a problem for the chosen model approach. The last point was surmounted by modelling cohorts of trees that germinated in particular years, but this signifies a high number of simulation runs since every large tree cohort has to be modelled in a separate model run.

The main purpose of the model ‘RegSnag’ was to simulate long-term succession for the montane and subalpine snag stands in the Gandberg forest with special regard to project the future density and height distribution of tree regeneration. This aim was achieved (cf. chapter IV C). The result of these long-term simulations will be used in the next chapters to answer the main questions about the protective effect of these snag stands.

V B Protective effect of snag stands over time

1. Protection provided by snags, stumps and logs

How long do snags, stumps and logs provide effective protection against natural hazards such as rock fall and snow avalanches? In spite of its importance, this question was not the main topic of the present thesis. However, some aspects regarding the former stand structure and the decay velocity were studied (chapter III A). In addition, simulations of snag decay and vegetation development (chapter IV B) provide some information on the future amount of snags and logs. The results can be summarised as follows:

Firstly, the former *Picea abies* stands on the Gandberg forest fulfilled the minimum requirements for effective protection against natural hazards, as introduced in chapter IA. The stands were sufficiently dense, with more than 500 trees ha⁻¹ and a growing stock of about 600-800 m³ ha⁻¹ (chapter III A). The stand density index (defined in chapter IA, section 1.1.1) calculated with a mean diameter at breast height of about 40 cm (37.2 ± 11.7 cm [mean ± standard error of the mean] on the subalpine level and 40.2 ± 11.5 cm on the montane level) was 1270-1697 and hence exceeded the target value of 800 by far. In addition, aerial photographs taken at that time show no larger gap.

Secondly, during the 8 years after *Picea abies* die-back, neither snow avalanches started in the Gandberg forest, nor occurred a larger rock fall in the snag stands. In 1997, a small rock fall originated in a montane snag stand, but it was effectively stopped by snags, stumps and logs after a few meters. Harvesting the snag stands would

very probably have increased the occurrence of avalanches, rock fall and erosion on this steep slope.

Thirdly, in 2000, about 75% of the snags in the Gandberg forest were already broken (chapter III A). In 2001, the height structure of the resulting piles of logs was similar to that in windthrow areas ten years after the storm 'Vivian' (chapter III A). There, Frey and Thee (2002) estimated that the stumps and logs are able to prevent snow movements effectively for about 30 years. In addition, ground surface roughness in windthrow areas was still enhanced after 30 years (Frey *et al.* 1995), so that some protection could be provided for an even longer time.

Fourthly, in 2001, coarse woody debris (CWD) and lying logs with direct ground contact on their whole length covered in average 6.5% of the site (chapter IV B). The remaining stems occurred either still as snags, or were piled up without major ground contact. In contrast, according to the RegSnag model, about 12% of the ground surface should be covered by lying logs, and 17% by CWD in 2023 (i.e. 30 years after *Picea* die-back, chapter IV C). This dramatic increase in lying logs and CWD clearly indicates a loss in protective effect in comparison to the current state with a higher proportion of snags and piled-up logs.

Finally, logs could be a danger themselves, as they could slide or roll downslope. Many logs were found far away from their stumps, due to the breakage processes (cf. chapter III A). However, observations do not suggest that logs moved large distances downslope, like in very steep (>50-55°) windthrow areas (cf. Frey *et al.* 1995). Hence this process is not important in the Gandberg forest, at least to date. Furthermore, some logs lay parallel to the contour lines (i.e. horizontally), in particular in the montane snag stands (chapter III A). This caused and will lead to further accumulation of other logs and some stones. Nevertheless, only small numbers of stones were retained as only few rockfalls occurred so far, and they will probably not constitute a risk in the future because of the large ground surface roughness.

In any case, the stability of snags, stumps and logs needs further study if the question of the durability of the protective effect is to be answered in more detail. It is therefore very welcome that Amman (2003) currently carries out pull-down experiments with stumps in the montane zone of the Gandberg forest to analyse the stability of broken snags.

To conclude, the results from this study and from windthrow areas suggest that the snags, stumps and logs have provided effective protection against natural hazards until now, and that this will continue for about the next 20 years, i.e. until about 30 years after *Picea* die-back (cf. Fig. 1).

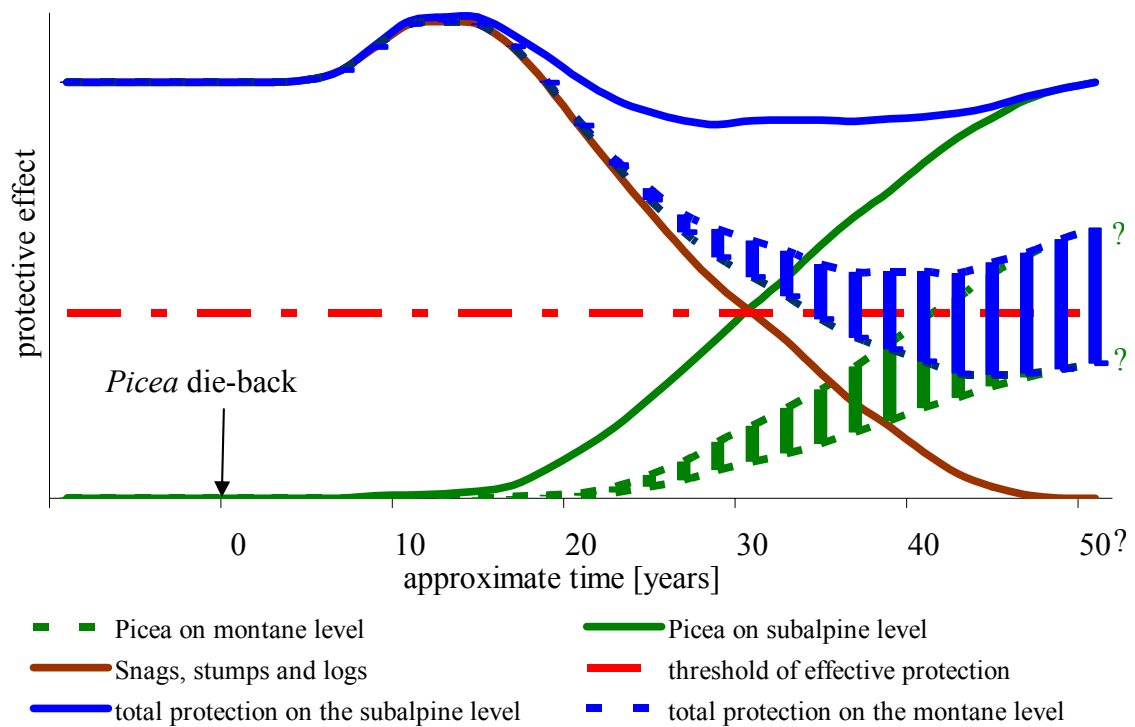

Fig. 1: Semi-quantitative, schematic representation of the development of the protection effect on the two elevational levels of the Gandberg forest based on field surveys and modelling: Total protection of the stands (blue lines) is the sum of the protection provided by snags, stumps, logs and their rotten remnants (brown line) and the *Picea abies* saplings (green lines). The closed green line shows the protective effect of *Picea* regeneration calculated with the parameters for the subalpine level. The dotted lines show the spectrum between an optimistic and a rather pessimistic estimation for the montane level, due to differences in future browsing intensities and seed availabilities.

2. Density and size of tree regeneration

In snag stands in protection forests, it is of crucial importance whether tree regeneration provides effective protection before the snags, stumps and logs lose their protective effect (Fig. 1). This leads to the key question how fast *Picea abies* and other trees will develop in a snag stand, and will form a new protection forest. To answer this question, the minimum requirements for effective protection in terms of density and size of tree regeneration (= the threshold values in Fig. 1) must be known.

Based on the literature review in the introduction (IA, section 1.1.2), I assumed that coniferous stands with about 500-1000 trees taller than about 5 m (ca. 8 cm dbh) and with only small treeless distances parallel to the slope (< 15 m) are effective for sufficiently reducing the risk of snow avalanches. The height of 5 m corresponds to about twice the height of the estimated 10-year maximum snow depth, and also exceeds the snow depth of the calculated 100-year snow depth recurrence in the Gandberg forest

(cf. chapter II A). The density and size of trees needed to prevent the passage of stones downwards through the stands is more difficult to estimate because only little information about stone size in the Gandberg forest is available. However, the 500-1000 trees ha⁻¹ taller than 5 m that are necessary for effective prevention against avalanches should also provide protection against stones with a diameter of <25 cm when these trees are distributed more or less uniformly (cf. chapter IA, section 1.1.1; effective prevention against rock fall if tree dbh is ca. 1/3 of the diameter of the stones).

We can compare the projections of the density and height of *Picea abies* made with the 'RegSnag' model in chapter IV C with these target values. According to the model simulations, the first *Picea* regeneration will be taller than 5 m at the earliest 30-35 years after the *Picea* die-back on both elevational levels (cf. Fig. 13 and 15 in chapter IV C). The projected density of *Picea* trees that are taller than 5 m at that time amounts to ca. 330 trees ha⁻¹ for the montane level (chapter VI C, section 6.2.1), and ca. 930 trees ha⁻¹ for the subalpine level (chapter IV C, section 6.2.2). Based on these simulations, the new tree generation in the snag stands on the subalpine level of the Gandberg will, provide effective protection against avalanches about 30 years after *Picea* die-back, if only the density and height of the trees are considered (cf. closed green line in Fig. 1). In contrast, the number of *Picea* saplings germinated in 1994 and 1996 on the montane level will probably be too low to ensure effective protection when they have reached the height of 5 m. Therefore, the prediction of the time at which the new trees on the montane level will be sufficiently numerous to provide effective protection against natural hazards – i.e. when the dotted green line intersects the read threshold line in Fig. 1 - depends strongly on two factors: (i) the future browsing pressure and (ii) further tree establishment from inflowing seeds. If the browsing pressure continues to be very high on the montane level, in combination with low seed availabilities in the next years, only very few *Picea abies* saplings will be able to establish. These *Picea* saplings will remain in the lower height classes for several decades (cf. Fig. 11 in chapter IV C), similar to the saplings of *Sorbus aucuparia* and *Acer pseudoplatanus*. Therefore, the protective effect of the tree regeneration will remain low during decades (cf. lower dotted line in Fig. 1). On the other hand, if we assume for the future a moderate browsing pressure comparable to that on the subalpine level, but similar seed inflows to those in the last years on the montane level (cf. Appendix 9.1.1 in chapter IV C), a sufficient amount of new *Picea* trees may already be present about 40 years after *Picea* die-back (cf. upper dotted line in Fig. 1). Unfortunately, both of these crucial factors - browsing intensity and the future seed rain - are prone to large uncertainty in the future. Therefore, not a single line is shown in Fig. 1 for the protection provided by the tree regeneration on the montane level, but a spectrum of possible developments.

3. Spatial distribution of tree regeneration

Regardless of the density and height of trees, treeless distances in downslope direction which exceed about 15-20 m can provoke problems with respect to the protective effect of a forest (cf. introduction chapter IA). How likely is it that such gaps will occur?

The frequency of *Picea* saplings on each microsite type in 2001 can be used to approximately estimate the spatial distribution of the *Picea* saplings, at least in 2001. According to the data sampled for model validation, *Picea* saplings were found on many different microsite types in 2001 (cf. Fig. 5 and 6 in chapter IV C). On the montane level, more than 5% of the *Picea* seedlings and saplings were found on the microsite types ‘CWD’, ‘Polytrichum’, ‘Hylocomium’, ‘MossFern’, ‘FernRubus’, ‘MossRubus’ and ‘OtherVegetation’ (cf. Fig. 5 in chapter IV C). Together, these seven microsite types covered at that time about 54% of the lower and upper montane level of the Gandberg (cf. Fig. 6 in chapter IV B). The two most frequent microsite types alone, i.e. ‘FernRubus’ and ‘MossRubus’, covered about 34% of the site (cf. Fig. 6 in chapter IV B) and ‘accommodated’ around 37% of the *Picea* regeneration (cf. Fig. 5 in chapter IV C). Furthermore, microsite types generally occurred in a mosaic of small patches on the montane level. Only very rarely did *Rubus idaeus* cover the entire length of a sampling line (cf. the difference between the 25%- and the 75%-quantiles in Fig. 6, chapter IV B, which was <10%). It can therefore be assumed that on the montane level it is unlikely that large tree-regeneration free gaps occurred in 2001. It is unlikely that until 2023 this should change dramatically, because dense *Rubus idaeus* brushwood which becomes the most abundant microsite type (cf. Fig. 14, in chapter IV C) evolves mostly out of the microsite types ‘MossRubus’ and ‘FernRubus’, and the *Picea* saplings established in these sites will probably not die as they have already reached a height in the upper half of the *Rubus* plants, or even overgrown *Rubus* (cf. microsite type ‘Picea’).

On the subalpine level, the situation appears to be different. *Picea* regeneration is mostly concentrated on the three microsite types ‘Root’, ‘CWD’ and ‘Polytrichum’ (Fig. 6 in chapter IV C). Only few *Picea* saplings were found on the microsite types ‘Hylocomium’, ‘Other Moss’, ‘MossFern’ and ‘OtherVegetation’ (cf. 2.7-5.3%, Fig. 6 in chapter IV C). The first 3 microsite types together made up 38.5% of the area in 2001, while together with the other types listed they covered about 58% of the surface (cf. Fig 7B in chapter IV B). However, the microsite types ‘Grass’ and ‘Fern’, on which tree regeneration was almost absent (cf. Fig. 6 in chapter IV C), covered 27.5% of the surface (cf. Fig 7B in chapter IV B). The spatial distribution of *Picea* regeneration was hence characterised by larger patches than on the montane level. However, the former stands on the subalpine level also had, between tree groups, large tree-free gaps covered with grasses and ferns. Generally, the clumpy stand structure of many high-elevation

forests reflects the mosaic of favourable and unfavourable microsites. The gaps without tree regeneration represent unsuitable conditions for seedling and sapling establishment (cf. discussion in Brang 1997). However, these tree-free gaps constitute a potential risk with respect to the protective effect of a stand. Fortunately, the subalpine snag stands in the Gandberg forest are in less steep terrain than the stands at the montane level, and hence probably constitute only a relatively modest risk.

In the future, however, these tree-free gaps probably will diminish in size because CWD will become abundant for several decades (cf. cover of around 17% in 2023, chapter IV C). The logs and stumps tend also to be distributed in a patchy manner (cf. orientation of logs, accumulation behind stumps and other logs, etc., see chapter III A), but the logs are normally long enough to extend across several microsites. Hence, rotten logs, which at least on the subalpine level are very suitable sites for *Picea* regeneration (i.e. ‘nurse logs’, cf. chapter IV C), will ensure a more even spatial distribution of *Picea* regeneration in the future. Of course, this last statement is based on the assumption that seed rain will be irregular in time, but will continue as in the last years, i.e. the scattered living trees and tree groups will survive and keep producing viable seeds together with adjacent stands. Otherwise, due to the lack of seeds, the new favourable sites for tree regeneration would not be used for further tree establishment.

The question about the spatial distribution of trees in the snag stands in the Gandberg forest can only be answered with less uncertainty by considering the coordinates of each individual tree, i.e. by modelling individual trees in a distance-dependent model. Alternatively, trees could be considered within small ($< 100 \text{ m}^2$), spatially located cells using a cellular automaton. However, such models cannot be based on data from 24 permanent plots of 1 m x 1 m, some randomly sampled trees and literature data, like the model ‘RegSnag’. To run a distance-dependent individual tree model or a cellular automaton, precise data about the location of each tree should be available. Furthermore, the model ‘RegSnag’ revealed that tree regeneration in such stands should not be modelled without considering the microsite types on which *Picea* saplings establish and grow. Collecting all the necessary data and developing a spatially explicit model would clearly go beyond the scope of a single PhD thesis.

V C Conclusions

During the first years after *Picea* die-back on the Gandberg, exceptional events like the storm Lothar in 1999 determined mostly the time of snag breakage. Thereby, stem breakage, not uprooting, was the more important process in *Picea* snag decay. Since the *Picea* die-back, the ground vegetation changed into raspberry brushwood (*Rubus idaeus*), or it became dominated by mosses, ferns and grasses (*Calamagrostis villosa*). But at the same time, the first tree regeneration established. Mostly *Picea* established, regardless of the high amount of bark litter which covered the surface. These saplings are still quite small today, except for some infrequent birch saplings. However, the simulations with the ‘RegSnag’ model suggest that *Picea* and not *Betula*, *Sorbus* or *Acer* trees will replace the current vegetation. In the case of moderate browsing pressure, i.e. at the subalpine level, the current *Picea* regeneration will probably provide effective protection against natural hazards about 30 years after the *Picea* die-back. Taking together the protective effect provided by snags, stumps and logs on the one hand and that by the new *Picea* generation on the other hand, I cautiously conclude that the Gandberg forest will probably provide effective protection also during this post-disturbance period (Fig. 1). Probably, the protective effect will first be maintained by the snags, stumps and logs, then by both the logs and the new *Picea* regeneration, and finally by the new *Picea* trees only (Fig. 1). However, at the montane level, the high browsing pressure of chamois may continue to reduce the growth of *Picea* saplings and therefore probably pose a risk for the protection effect provided in the next decades by the snag stands (cf. lower dotted line in Fig. 1).

Nevertheless, the amount of future tree regeneration, particularly on CWD, will greatly affect the long-term protective effect of these stands. The long-term suitability of CWD for *Picea* regeneration will contribute to building stands which are more uneven-aged than the pre-disturbance stands, and hence make the new stands less susceptible to large-scale disturbance. However, the stands are unlikely to become more diverse in tree species because pressure from browsing ungulate will prevent a greater proportion of *Abies alba*, *Acer pseudoplatanus* and *Sorbus aucuparia*. Despite these uncertainties, the study shows that the protective effect of snag stands left unharvested may persist for at least several decades

VI REFERENCES OF CHAPTERS I, II, IV A AND V

- Aavisksoo K. (1993): Changes of plant cover and land use types (1950's to 1980's) in three mire reserves and their neighbourhood in Estonia. *Landsc. Ecol.* **8**(4): 287-301.
- Acevedo M.F., Urban D.L. & Shugart H.H. (1996): Models of forest dynamics based on roles of tree species. *Ecol. Model.* **87**: 267-284.
- Amman M. (2003): Schutzwirkung abgestorbener Bäume gegen Naturgefahren. *Forschungsplan*, Departement Forstwissenschaften, ETH, Zürich.
- Badeck F.W., Lischke H., Bugmann H., Hickler T., Hönninger K., Lasch P., Lexer M.J., Mouillot F., Schaber J. & Smith B. (2001): Tree species composition in European pristine forests: comparison of stand data to model predictions. *Clim. Chang.* **51**: 307-347.
- Baumgartner M. (2002): Detaillierte Ersterhebungen in einem steinschlaggeschädigten Wald im Diemtigtal. *Diplomarbeit*. Geographisches Institut, Universität Bern, Bern.
- Bebi P. (2000): Erfassung von Strukturen im Gebirgswald als Beurteilungsgrundlage ausgewählter Waldwirkungen. *Beih. Schweiz. Z. Forstwes.* **90**:1-128.
- Bebi P., Kienast F. & Schönenberger W. (2001): Assessing structures in mountain forests as a basis for investigating the forests dynamics and protective function. *For. Ecol. Manage.* **145**(1-2): 3-14.
- Benz J. (2003): WWW-Server for Ecological Modelling. Internet <<http://eco.wiz.uni-kassel.de/ecobas.html>>. Access: 17.4.2003.
- Bossel H. & Krieger H. (1991): Simulation model of natural tropical forest dynamics. *Ecol. Model.* **59**(1-2): 37-71.
- Bossel H. & Krieger H. (1994): Simulation of multispecies tropical forest dynamics using a vertically and horizontally structured model. *For. Ecol. Manage.* **69**(1-3): 123-144.
- Botkin D.B., Janak J.F. & Wallis J.R. (1972): Some ecological consequences of a computer model of forest growth. *J. Ecol.* **60**: 849-872.
- Boyer J.F. (1979): The terminology of Markov Chains. *J. Theor. Biol.* **78**: 443-447.
- Brändli U.-B. & Herold A. (1999): LFI 2 - Schutzwald. In: Peter Brassel & Urs-Beat Brändli (eds.), *Schweizerisches Landesforstinventar. Ergebnisse der Zweitaufnahme 1993-1995*. Verlag Paul Haupt, Bern. 331-354.
- Brang P. (1996): Experimentelle Untersuchungen zur Ansamungsökologie der Fichte im zwischenalpinen Gebirgswald. *Beih. Schweiz. Z. Forstwes.* **77**: 1-375.
- Brang P. (1997): Ecological niches of seedling establishment in high-elevation forests. In: Chris Hollstedt & Alan Vyse (eds.), *Sicamous Creek Silvicultural Systems Project: Workshop Proceedings*. Research Branch, B.C. Ministry of Forests, Victoria, B.C, Kamloops, British Colombia, Canada. 144-153.
- Brang P. (1998): Early seedling establishment of *Picea abies* in small forest gaps in the Swiss Alps. *Can. J. For. Res.* **28**(4): 626-639.
- Brang P. & Duc P. (2002): Zu wenig Verjüngung im Schweizer Gebirgs-Fichtenwald: Nachweis mit einem neuen Modellansatz. *Schweiz. Z. Forstwes.* **153**(6): 219-227.

- Brang P. & Lässig R. (2000): Restoring protection against natural hazards in European mountain forests after wind disturbance: how much human interference? In: XXI IUFRO World Congress (ed.) *Forests and society: the role of research. Sub-Plenary Sessions*, Kuala Lumpur, Malaysian. 328-337.
- Brang P., Schönenberger W., Ott E. & Gardner B. (2001): Forests as protection from natural hazards. In: Julian Evans (ed.) *The forest handbook*. Blackwell Science. 53-81.
- Brassel P. & Brändli U.-B. (1999): *Schweizerisches Landesforstinventar. Ergebnisse der Zweitaufnahme 1993-1995*. Verlag Paul Haupt, Bern. 442 p.
- Bründl M., Bartelt P., Schneebeli M. & Flühler H. (1999a): Measuring branch deflection of spruce branches caused by intercepted snow load. *Hydrol. Process.* **13**(14-15): 2357-2369.
- Bründl M., Schneebeli M. & Flühler H. (1999b): Routing of canopy drip in the snowpack below a spruce crown. *Hydrol. Process.* **13**(1): 49-58.
- Bugmann H. (1994): On the ecology of mountainous forests in a changing climate: A simulation study. *PhD thesis*. ETH, Zürich. 258 p.
- Bugmann H. (2000): Dynamische Modelle in den Forstwissenschaften. *Skript zur Vorlesung*, Gebirgswaldökologie, ETH, Zürich. 95 p.
- Bugmann H. (2001): A review of forest gap models. *Clim. Chang.* **51**: 259-305.
- Bugmann H., Marti F. & Wallimann K. (1989): Auswirkungen eines Phosphorsäureesters (Insektizid Ekamet) auf die Planktonbiozönose des Greifensees. *Diplomarbeit*. Institut für Gewässerschutz und Wassertechnologie, Institut für Wald- und Holzforschung, ETH Zürich und EAWAG Dübendorf. 232 p.
- Buongiorno J. & Michie B.R. (1980): A matrix model of uneven-aged forest management. *For. Sci.* **26**(4): 609-625.
- Buongiorno J., Peyron J.L., Houllier F. & Bruciamacchie M. (1995): Growth and management of mixed-species, uneven-aged forests in the French Jura - implications for economic returns and tree diversity. *For. Sci.* **41**(3): 397-429.
- Burger H. (1952): Holz, Blattmenge und Zuwachs. XII. Fichten im Plentnerwald. *Mitt. schweiz. Anst. forstl. Vers.wes.* **28**: 109-156.
- Burger H. (1953): Holz, Blattmenge und Zuwachs. XIII. Fichten im gleichaltrigen Hochwald. *Mitt. schweiz. Anst. forstl. Vers.wes.* **29**: 38-130.
- Burkart A. (2001): Einschätzung - Samenbehang. *interner Bericht*, Eid. Forschungsanstalt WSL, Birmensdorf. 8 p.
- Buwal (1994): *Sturmschäden 1990 im Schweizer Wald*. Bundesamt für Umwelt, Wald und Landschaft (BUWAL), Bern.
- Buwal (2000): *Entscheidungshilfe bei Sturmschäden im Wald*. Bundesamt für Umwelt, Wald und Landschaft (BUWAL), Bern. 100 p.
- Camaret S. (1997): Rôle des perturbations dans la dynamique des pessières d'altitude. Impact d'ouvertures artificielles et naturelles sur la régénération et le développement d'un peuplement forestier. *Thèse de doctorat*. Université de Savoie, Chambéry. 264 p.
- Cameron A.D. (1996): Managing birch woodlands for the production of quality timber. *Forestry* **69**(4): 357-371.
- Carmignola G., Nogglar W. & Stffler J. (1998): Erfahrungen mit SOLL-Werten im Rahmen der Wildschadenserhebung in Südtirol. *Forstl. Schr.reihe Univ. Bodenkultur Wien* **12**: 265-274.

- Caswell H. (2001): *Matrix population models*. Sunderland, Mass. Sinauer Associates. 722 p.
- Cattiau V., Mari E. & Renaud J.-P. (1995): Forêt et protection contre les chutes de rochers. *Ingénieries: EAT* **1**(3): 45-54.
- Chauvin C., Renaud J.-P., Rupé C. & Leclerc D. (1994): Stabilité et gestion des forêts de protection. *Bull. tech.* **27**(27): 37-52.
- Chave J. (1999): Study of structural, successional and spatial patterns in tropical rain forests using TROLL, a spatially explicit forest model. *Ecol. Model.* **124**(2-3): 233-254.
- Cherrill A.J., McClean C., Watson P., Tucker K., Rushton S.P. & Sanderson R. (1995): Predicting the distributions of plant species at the regional scale: a hierarchical matrix-model. *Landsc. Ecol.* **10**(4): 197-207.
- Courbaud B. (2000): Comparing light interception with stand basal area for predicting tree growth. *Tree Physiol.* **20**(5-6): 407-414.
- Courbaud B., Goreaud F., Dreyfus P. & Bonnet F.R. (2001): Evaluating thinning strategies using a tree distance dependent growth model: some examples based on the CAPSIS software "uneven-aged spruce forests" module. *For. Ecol. Manage.* **145**(1-2): 15-28.
- Courbaud B., Houllier F. & Rupe C. (1993): A model for height growth of trees in uneven-aged spruce mountain forest. *Ann. Sci. For.* **50**(4): 337-351.
- Dobbertin M. (2002): Influence of stand structure and site factors on wind damage comparing the storms Vivian and Lothar. *For. Snow Landsc. Res.* **77**(1/2): 187-205.
- Dorren L.K.A., Maier B., Putter U.S. & Seijmonsbergen A.C. (2003): Combining field and modelling techniques to assess rockfall dynamics on a protection forest hillslope in the European Alps. *Geomorphology* **1367**: 1-17.
- Eidg. Forschungsanstalt WSL & Bundesamt für Umwelt, Wald und Landschaft BUWAL (2001): *Lothar. Der Orkan 1999. Ereignisanalyse*. Eidg. Forschungsanstalt WSL, Bundesamt für Umwelt, Wald und Landschaft (BUWAL), Birmensdorf, Bern. 365 p.
- Ek A.R. & Monserud R.A. (1974): FOREST: A computer model for simulating the growth and reproduction of mixed species stands. Univ. Wisconsin. 90 p.
- Ek A.R. & Monserud R.A. (1979): Performance and comparison of stand growth models based on individual tree and diameter-class growth. *Can. J. For. Res.* **9**: 231-244.
- Enright N. & Ogden J. (1979): Applications of transition matrix models in forest dynamics - *Araucaria* in Papua New Guinea and *Nothofagus* in New Zealand. *Aust. J. Ecol.* **4**(1): 3-23.
- Enright N.J. & Watson A.D. (1991): A matrix population-model analysis for the tropical tree, *Araucaria-Cunninghamii*. *Aust. J. Ecol.* **16**(4): 507-520.
- Erni V. & Lemm R. (1995): Ein Simulationsmodell für den Forstbetrieb - Entwurf, Realisierung und Anwendung. *Ber. Eidg. Forsch.anst. WSL* (341): 89.
- Ferguson D.E. & Carlson C.E. (1993): Predicting regeneration establishment with the PROGNOSIS model. *USDA For. Serv. Res. Pap.* **INT-467**: 1-54.
- Fischlin A., Bugmann H. & Gyalistras D. (1995): Sensitivity of a forest ecosystem model to climate parametrization schemes. *Environ. Pollut.* **87**(3): 267-282.
- Forster B. (1998): Storm damages and bark beetle management: how to set priorities. In: W. Grodzki, M. Knizek & B. Forster (eds.), *Methodology of Forest Insect and*

- Disease Survey in Central Europe*, IUFRO Workshop, Ustron - Jaszowiec (Poland). 161-165.
- Forstverwaltung Kt. Glarus (1949): Wirtschaftsplan über die Gemeindewaldungen von Schwanden (1. Revision). *Unveröffentlicht*. Forstverwaltung Kt. Glarus, Glarus.
- Frehner M. (1989): Beobachtungen zur Einleitung der Naturverjüngung an einem nordexponierten Steilhang im subalpinen Fichtenwald. *Schweiz. Z. Forstwes.* **140**: 1013-1022.
- Frehner M. (2000): Untersuchungen über den Einfluss unterschiedlicher Kleinstandorte und der Pflanztechnik auf Fichtenpflanzungen in subalpinen Lawinenschutzwäldern. *Beih. Schweiz. Z. Forstwes.* **92**.
- Frey W., Forster B., Gerber W., Graf F., Heiniger U., Kuhn N. & Thee P. (1995): Risiken und Naturgefahren auf Windwurfflächen. *Schweiz. Z. Forstwes.* **146**(11): 863-872.
- Frey W. & Thee P. (2002): Avalanche protection of windthrow areas: A ten year comparison of cleared and uncleared starting zones. *For. Snow Landsc. Res.* **77**(1/2): 89-107.
- Friend A.D., Stevens A.K., Knox R.G. & Cannell M.G.R. (1997): A process-based, terrestrial biosphere model of ecosystem dynamics (Hybrid v3.0). *Ecol. Model.* **95**: 249-287.
- Fulton M.R. (1991): A computationally efficient forest succession model: design and initial tests. *For. Ecol. Manage.* **42**: 23-34.
- Golser M. & Hasenauer H. (1996): Height growth development of Norway spruce, fir and common beech regeneration in uneven-aged mixed species stands. In: J. P. Skovsgaard & V. K. Johannsen (eds.), *IUFRO Conference*. Danish Forest and Landscape Research Institute, Copenhagen. 493-503.
- Golser M. & Hasenauer H. (1997): Predicting juvenile tree height growth in uneven-aged mixed species stands in Austria. *For. Ecol. Manage.* **97**(2): 133-146.
- Goslee S.C., Peters D.P.C. & Beck K.G. (2001): Modeling invasive weeds in grasslands: the role of allelopathy in *Acroptilon repens* invasion. *Ecol. Model.* **139**(1): 31-45.
- Gsteiger P. (1990): Steinschlag Wald Relief; Empirische Grundlagen zur Steinschlagmodellierung. *Diplomarbeit*. Geographisches Institut, Universität Bern, Bern. 111 p.
- Harper J.L., Williams I.T. & Sagar G.R. (1965): The behavior of seeds in soil. The heterogeneity of soil surfaces and its role in determining the establishment of plants from seed. *J. Ecol.* **53**: 273-286.
- Harrison T.P. & Michie B.R. (1985): A generalized approach to the use of matrix growth models. *For. Sci.* **31**(4): 850-856.
- Hasenauer H., Burgmann M. & Lexer M.J. (2000): Konzepte der Waldökosystemmodellierung. *Cent.bl. gesamte Forstwes.* **117**(3/4): 137-164.
- Hillebrand K. & Leder B. (1995): Die Vogelbeere als eine interessante Mischbaumart für Fichten-Hochlagenbestände. *LÖBF-Jahresbericht*: 143-151.
- Hochstrasser T., Kroel-Dulay G., Peters D.P.C. & Gosz J.R. (2002): Vegetation and climate characteristics of arid and semi-arid grasslands in North America and their biome transition zone. *J. Arid. Environ.* **51**(1): 55-78.
- Hoffmann W.A. (1999): Fire and population dynamics of woody plants in a neotropical savanna: Matrix model projections. *Ecology* **80**(4): 1354-1369.

- Horn H.S. (1975): Markovian properties of forest succession. In: M.L. Cody & J.M. Diamond (eds.), *Ecology and evolution of communities*. The Belknap Press of Harvard University, Cambridge. 545.
- Huhta A.P., Rautio P., Tuomi J. & Laine K. (2001): Restorative mowing on an abandoned semi-natural meadow: Short- term and predicted long-term effects. *J. Veg. Sci.* **12**(5): 677-686.
- Humphries H.C., Coffin D.P. & Lauenroth W.K. (1996): An individual-based model of alpine plant distributions. *Ecol. Model.* **84**: 99-126.
- Hunziker U. & Brang P. (submitted): Microsite patterns of conifer seedling establishment and growth in a mixed stand in the southern Alps. *For. Ecol. Manage.*
- Huth A. & Ditzer T. (2000): Simulation of the growth of a lowland Dipterocarp rain forest with FORMIX 3. *Ecol. Model.* **134**: 1-25.
- Huth A., Ditzer T. & Bossel H. (1998): The rain forest growth model FORMIX 3 - Model description and analysis of forest growth and logging scenarios for the Dermakot Forest Reserve (Malaysia). *Göttinger Beitr. Land- und Forstwirtschaft. Trop. Subtrop.* **124**: 1-182.
- Imbeck H. & Ott E. (1987): Verjüngungsökologische Untersuchungen in einem hochstaudenreichen subalpinen Fichtenwald, mit spezieller Berücksichtigung der Schneeablagerung und der Lawinenbildung. *Mitt. Eidgenöss. Inst. Schnee-Lawinenforsch.* **42**: 202.
- IUFRO (1990): *Vocabulary of Forest Management - Wörterbuch der Forsteinrichtung*. Vienna IUFRO, Birmensdorf WSL, (IUFRO World Series, 1).
- Jehl H. (1995): Die Waldentwicklung auf Windwurfflächen im Nationalpark Bayerischer Wald. In: Nationalparkverwaltung Bayerischer Wald (ed.) *25 Jahre auf dem Weg zum Naturwald*. Nationalparkverwaltung Bayerischer Wald, Neuschönau. 112-146.
- Jorritsma I.T.M., Van Hees A.F.M. & Mohren G.M.J. (1999): Forest development in relation to ungulate grazing: a modeling approach. *For. Ecol. Manage.* **120**: 23-34.
- Kägi B. (1992): Pflanzensoziologische Karte des Gandbergwaldes. *Unveröffentlicht*, Forstdirektion Kt. Glarus, Glarus.
- Kaltenbrunner A. (1993): Methodenbeitrag zur Ermittlung der Lawinenschutzfunktion subalpiner Wälder. *Diplomarbeit*. Professur Waldbau, ETH, Zürich. 79 p.
- Kapos V., Rhind J., Edwards M., Ravilious C. & Price M.F. (2000): Developing a map of the world's mountain forests. In: M.F. Price & N. Butt (eds.), *Forests in sustainable mountain development: A state-of-knowledge report for 2000*. CAB International, Wallingford, UK.
- Keane R.E., Austin M., Field C., Huth A., Lexer M.J., Peters D., Solomon A. & Wyckoff P. (2001): Tree mortality in gap models: Application to climate change. *Clim. Chang.* **51**(3-4): 509-540.
- Keane R.E., Morgan P. & Running S.W. (1996): FIRE-BGC - A mechanistic ecological process model for simulating fire succession on coniferous forest landscapes of the northern Rocky Mountains. *USDA For. Ser. INT RP-485*: 1-123.
- Keller F., Lischke H., Mathis T., Mohl A., Wick L., Ammann B. & Kienast F. (2002): Effects of climate, fire, and humans on forest dynamics: forest simulations compared to the palaeological record. *Ecol. Model.* **152**(2-3): 109-127.

- Kellomäki S. & Väisänen H. (1991): Application of a gap model for the simulation of forest ground vegetation in boreal conditions. *For. Ecol. Manage.* **42**: 35-47.
- Kienast F., Fritschi J., Bissegger M. & Abderhalden W. (1999): Modelling successional patterns of high-elevation forests under changing herbivore pressure - responses at the landscape level. *For. Ecol. Manage.* **120**: 35-46.
- Kienast F. & Kräuchi N. (1991): Simulated successional characteristics of managed and unmanaged low-elevation forest in Central-Europe. *For. Ecol. Manage.* **42**: 49-61.
- Kobe R.K., Pacala S.W., Silander J.A. & Canham C.D. (1995): Juvenile tree survivorship as a component of shade tolerance. *Can. J. For. Res.* **5**(2): 517-532.
- Kolbe A.E., Buongiorno J. & Vasievich M. (1999): Geographic extension of an uneven-aged, multi-species matrix growth model for northern hardwood forests. *Ecol. Model.* **121**(2-3): 235-253.
- Kolström T. (1993): Modelling the development of an uneven-aged stand of *Picea abies*. *Scand. J. For. Res.* **8**(3): 373-383.
- Kruys N., Jonsson B.G. & Stahl G. (2002): A stage-based matrix model for decay-class dynamics of woody debris. *Ecol. Appl.* **12**(3): 773-781.
- Küchli C. & Baumgartner H. (2001): *Umweltschutz begann im Wald. Umwelt: Schweizer Wald: von der Katastrophe zur Erfolgsgeschichte und jetzt?* Bundesamt für Umwelt, Wald und Landschaft (BUWAL), Bern. 6-9.
- Kuoch R. (1965): Der Samenfall 1962/63 an der oberen Fichtenwaldgrenze im Sertigtal. *Mitt. EAFV* **41**: 61-85.
- Kupferschmid A.D. (2001): Neues Leben im Totholzbestand auf dem Gandberg. In: Thomas Rageth (ed.) *Binding Preis für vorbildliche Waldpflege 2001: Vivian als Chance. Gemeinde Schwanden GL*. Sophie und Karl Binding Stiftung, Basel. 51-57.
- Landestopographie (1997): *Atlas der Schweiz*. Verlag des Bundesamtes für Landestopographie, Wabern-Bern.
- Landestopographie (2001): *Hydrological atlas of Switzerland*. Landeshydrologie, Bundesamt für Wasser und Geologie, Bundesamt für Landestopographie, Wabern-Bern.
- Lässig R., Egli S., Odermatt O., Schönenberger W., Stöckli B. & Wohlgemuth T. (1995): Beginn der Wiederbewaldung auf Windwurfflächen. *Schweiz. Z. Forstwes.* **146**(11): 893-911.
- Leak W.B. (1986): Birch regeneration: a stochastic model. *USDA For. Serv. Res. Note NE-85*: 1-7.
- Leibundgut H. (1984): *Die natürliche Waldverjüngung*, 2nd edition. Verlag Paul Haupt, Bern.
- Lexer M.J. & Hönninger K. (2001): A modified 3D-patch model for spatially explicit simulation of vegetation composition in heterogeneous landscapes. *For. Ecol. Manage.* **144**(1-3): 43-65.
- Lexer M.J., Hönninger K., Scheifinger H., Matulla C., Groll N., Kromp-Kolb H., Schadauer K., Starlinger F. & Englisch M. (2002): The sensitivity of Austrian forests to scenarios of climatic change: a large-scale risk assessment based on a modified gap model and forest inventory data. *For. Ecol. Manage.* **162**(1): 53-72.
- Lin C.R., Buongiorno J. & Vasievich M. (1996): A multi-species, density-dependent matrix growth model to predict tree diversity and income in northern hardwood stands. *Ecol. Model.* **91**(1-3): 193-211.

- Lindner M., Sievänen R. & Pretzsch H. (1997): Improving the simulation of stand structure in a forest gap model. *For. Ecol. Manage.* **95**: 183-195.
- Lischke H. (2001): New development in forest modeling: convergence between applied and theoretical approaches. *Nat. Resour. Model.* **14**(1): 71-102.
- Lischke H., Ammann B., Roberts D.W. & Zimmermann N.E. (2001): Developing a physiologically mechanistic tree migration model and simulating Holocene spread of forest trees. Zimmermann, N.E., WSL, Internet: <http://www.wsl.ch/staff/niklaus.zimmermann/laasim/treeming.html>. Access: 17.07.2001. Last update: 19.04.1999.
- Lischke H. & Fischlin A. (2002): Systemökologie. *Vorlesungs-Skript SS 2002 Teil 2*, Eidg. Forschungsanstalt WSL, Birmensdorf. 36 p.
- Lischke H., Löffler T.J. & Fischlin A. (1998): Aggregation of individual trees and patches in forest succession models: capturing variability with height structured, random, spatial distributions. *Theor. Pop. Biol.* **54**: 213-226.
- Lischke H., Lotter A. & Fischlin A. (2002): Untangling a Holocene pollen record with forest model simulations and independent climate data. *Ecol. Model.* **150**(1-2): 1-21.
- Liu J.G. & Ashton P.S. (1998): FORMOSAIC: An individual-based spatially explicit model for simulating forest dynamics in landscape mosaics. *Ecol. Model.* **106**(2-3): 177-200.
- Liu L. & Ashton P.S. (1995): Individual-based simulation models for forest succession and management. *For. Ecol. Manage.* **73**(1-3): 157-175.
- Löffler T.J. & Lischke H. (2001): Incorporation and influence of variability in an aggregated forest model. *Nat. Resour. Model.* **14**(1): 103-137.
- Lu H.C. & Buongiorno J. (1993): Long and short-term effects of alternative cutting regimes on economic returns and ecological diversity in mixed-species forests. *For. Ecol. Manage.* **58**(3-4): 173-192.
- Lüscher F. (1990): Untersuchungen zur Höhenentwicklung der Fichtennaturverjüngung im inneralpinen Gebirgswald. *Dissertation*. Professur Waldbau, Departement Forstwissenschaften, ETH, Zürich. 138 p.
- Mahrer F., Bachofen H., Brändli U.-B., Brassel P., Kasper H., Peter L., Riegger W., Stierlin H.-R., Strobel T., Sutter R., Weenger C., Winzeler K. & Zingg A. (1988): *Schweizerisches Landesforstinventar: Ergebnisse der Erstaufnahme 1982-1986*. Eidg. Anst. forst. Vers.wes., Birmensdorf. 375 p.
- Marti F. (1995): *Sturmschäden im Glarner Wald vom 27./28.2.1990. Schlussbericht*. Unpubliziert, Kantonsforstamt Glarus, Glarus. 53 p.
- Mayer H. & Ott E. (1991): *Gebirgswaldbau Schutzwaldflege; Ein waldbaulicher Beitrag zur Landschaftsökologie und zum Umweltschutz*, 2nd edition. Gustav Fischer Verlag, Stuttgart. 587 p.
- Mencuccini M., Piussi P. & Zanzi Sulli A. (1995): Thirty years of seed production in a subalpine Norway spruce forest: Patterns of temporal and spatial variation. *For. Ecol. Manage.* **76**: 109-125.
- Meyer-Grass M. (1985): Waldlawinen: Gefährdete Bestände, Massnahmen. *Merkblatt EISLF 1*: 6.
- Meyer-Grass M. & Imbeck H. (1985): Waldsterben und Lawinengefahr. *Neue Zürcher Zeitung*. Zürich. 65-66.
- Meyer-Grass M. & Schneebeli M. (1992): Die Abhängigkeit der Waldlawinen von Standorts-, Bestandes- und Schneeverhältnissen. In: G. Fiebiger & F. Zollinger

- (eds.), *Schutz des Lebensraumes vor Hochwasser, Muren und Lawinen. Internationales Symposium Interpraevent 1992, Bern, Tagungspublikation.* Forschungsgesellschaft für Vorbeugende Hochwasserbekämpfung, Klagenfurt. 443-454.
- Mohren G.M.J. & Vanderveen J.R. (1995): Forest growth in relation to site conditions: Application of the model FORGRO to the Solling spruce site. *Ecol. Model.* **83**(1-2): 173-183.
- Monserud R.A. & Ek A.R. (1977): Prediction of understory tree height growth in northern hardwood stands. *For. Sci.* **23**(3): 391-400.
- Morrison M.L. & Raphael M.G. (1993): Modeling the dynamics of snags. *Ecol. Appl.* **3**(2): 322-330.
- Mössmer E. (1998): Ohne Schutzwald geht's bergab! *Allg. Forstztg.* (21): 1284-1285.
- Mössmer E.-M., Ammer U. & König A. (1990): Eignung von Baumarten zur Verjüngung gleitschneegefährdeter Schutzwaldflächen im bayrischen Hochgebirge. *Allg. Forstztg. (Wien)* **9-10**(45): 222-224.
- Mössnang M. & Kühnel S. (1999): Natürliche Verjüngung auf Sturmwurfflächen vom Februar 1990 in Bayern: Ergebnisse von Dauerbeobachtungen und Folgerungen für die Praxis. *Forstl. Forsch.ber. München* **176**: 61-69.
- Müller P. & Zopfi P. (1999): Vom Wildschutz zum Naturschutz. In: *450 Jahre Freiberg Kärpf.* Verlag Neujahrsbote, Linthal. 11-17.
- Oberholzer J. & Heim A. (1910): *Geologische Karte der Glarneralpen 1:50'000.* (Spezialkarte Nr. 50), Schweiz. Geol. Kommission, Kartographia AG, Winterthur.
- Örlander G. & Karlsson C. (2000): Influence of shelterwood density on survival and height increment of *Picea abies* advance growth. *Scand. J. For. Res.* **15**: 20-29.
- Osho J.S.A. (1991): Matrix model for tree population projection in a tropical rain forest of south-western Nigeria. *Ecol. Model.* **59**(3-4): 247-255.
- Ott E. (1989): Verjüngungsprobleme in hochstaudenreichen Gebirgsnadelwäldern. *Schweiz. Z. Forstwes.* **140**(1): 23-42.
- Ott E. (1996): Leitbilder zur Schutzwirkung des Waldes vor Lawinenbildung. *Forstwiss. Cent.bl.* **115**(4/5): 223-230.
- Ott E., Frehner M., Frey H.-U. & Lüscher P. (1997): *Gebirgsnadelwälder: Ein praxisorientierter Leitfaden für eine standortgerechte Waldbehandlung.* Verlag Paul Haupt, Bern, Stuttgart, Wien. 287 p.
- Ott E., Lüscher F., Frehner M. & Brang P. (1991): Verjüngungsökologische Besonderheiten im Gebirgsfichtenwald im Vergleich zur Bergwaldstufe. *Schweiz. Z. Forstwes.* **142**(11): 879-904.
- Pacala S.W., Canham C.D., Saponara J., Silander J.A., Kore R.K. & Ribbens E. (1996): Forest models defined by field measurements: estimation, error analysis and dynamics. *Ecol. Monogr.* **66**(1): 1-43.
- Peters D.P.C. (2002): Plant species dominance at a grassland-shrubland ecotone: an individual-based gap dynamics model of herbaceous and woody species. *Ecol. Model.* **152**(1): 5-32.
- Picard N., Bar-Hen A. & Guedon Y. (2003): Modelling diameter class distribution with a second-order matrix model. *For. Ecol. Manage* **180**(1-3): 389-400.
- Porté A. & Bartelink H.H. (2002): Modelling mixed forest growth: a review of models for forest management. *Ecol. Model.* **150**(1-2): 141-188.
- Prentice I.C. & Leemans R. (1990): Pattern and process and the dynamics of forest structure: a simulation approach. *J. Ecol.* **78**: 340-355.

- Prentice I.C., Sykes M.T. & Cramer W. (1993): A simulation model for transient effects of climate change on forest landscapes. *Ecol. Model.* **65**: 51-70.
- Pretzsch H. (1992): Konzeption und Konstruktion von Wachstumsmodellen für Rein- und Mischbestände. *Forstl. Forsch.ber. Münch.* **115**: 1-358.
- Pretzsch H. (2001): Models for pure and mixed forests. In: Julian Evans (ed.) *The forest handbook*. Blackwell Science Ltd. 210-228.
- Pretzsch H. & Dursky J. (2002): Growth reaction of Norway spruce (*Picea abies* (L.) Karst.) and European beech (*Fagus sylvatica* L.) to possible climatic changes in Germany. A sensitivity study. *Forstwiss. Cent.bl.* **121**: 145-154.
- Price D.T., Zimmermann N.E., Van Der Meer P.J., Lexer M.J., Leadley P., Jorritsma I.T.M., Schaber J., Clark D.F., Lasch P., McNulty S., Wu J.G. & Smith B. (2001): Regeneration in gap models: Priority issues for studying forest responses to climate change. *Clim. Chang.* **51**(3-4): 475-508.
- Pukkala T. & Kolström T. (1988): Simulation of the development of Norway spruce stands using a transition matrix. *For. Ecol. Manage.* **25**: 255-267.
- Pukkala T., Miina J., Kurttila M. & Kolström T. (1998): A spatial yield model for optimizing the thinning regime of mixed stands of *Pinus sylvestris* and *Picea abies*. *Scand. J. For. Res.* **13**(1): 31-42.
- Raphael M.G. & Morrison M.L. (1987): Decay and dynamics of snags in the Sierra Nevada, California (USA). *For. Sci.* **33**(3): 774-783.
- Reimoser F. (1998): Zieldefinition und SOLL-IST-Vergleich am Beispiel des Verbiss-Vergleichsflächenverfahrens Vorlaberg. *Forstl. Schr.reihe Univ. Bodenkultur Wien* **12**: 221-239.
- Rickli C. (2000): *Vegetationswirkungen und Rutschungen. Untersuchung zum Einfluss der Vegetation auf oberflächennahe Rutschprozesse anhand der Unwetterereignisse in Sachseln OW am 15. August 1997*. Eidg. Forschungsanstalt WSL, Bundesamt für Umwelt, Wald und Landschaft (BUWAL), Birmensdorf, Bern. 97 p.
- Roth I. (1996): Untersuchungen über die forstliche Ansamung in einem abgestorbenen Fichtenbestand, Objekt: Gandberg oberhalb Schwanden GL. *Diplomarbeit*. Departement Wald- und Holzforschung, ETH, Zürich. 99 p.
- Rottmann M. (1985): *Schneebruchschäden in Nadelholzbeständen: Beiträge zur Beurteilung der Schneebruchgefährdung, zur Schadensvorbeugung und zur Behandlung schneegeschädigter Nadelholzbestände*. J. D. Sauerländers's Verlag, Frankfurt a.M. 159 p.
- Scanlan J.C. & Archer S. (1991): Simulated dynamics of succession in a North-American subtropical *Prosopis*-savanna. *J. Veg. Sci.* **2**(5): 625-634.
- Schmidt A. (1983): *Der Freiberg Kärpf; Das älteste Wildschutzgebiet der Schweiz in den Glarner Alpen*. Buchhandlung Baeschlin, Glarus.
- Schmidt-Schütz A. (1999): Wiederbewaldung von Fichten-Sturmwurfflächen auf vernässenden Standorten mit Hilfe von Pioniergehölzen. *Forstl. Forsch.ber. München* **176**: 120-130.
- Schodterer H. (1998): Herleitung von Sollpflanzenzahlen als Beurteilungskriterium für die Auswertung der Verjüngungs- und Verbissaufnahmen der Österr. Waldinventur 1992-96. *Forstl. Schr.reihe Univ. Bodenkultur Wien* **12**: 281-286.
- Schönenberger W. (1975): Standortseinflüsse auf Versuchsaufforstungen an der alpinen Waldgrenze (Stillberg, Davos). *Mitt. EAFV* **51**: 357-428.

- Schönenberger W. (2000): Silvicultural problems in subalpine forests in the Alps. In: M.F. Price & N. Butt (eds.), *Forests in sustainable mountain development: a state of knowledge report for 2000*. CABI Publishing. 197-203.
- Schönenberger W. (2001): Cluster afforestation for creating diverse mountain forest structures - a review. *For. Ecol. Manage.* **145**(1-2): 121-128.
- Schönenberger W., Frey W. & Leuenberger F. (1990): Ökologie und Technik der Aufforstung im Gebirge: Anregungen für die Praxis. *Ber. WSL* **325**: 58.
- Schönenberger W. & Rüschi W. (1990): Wiederbewaldung nach Sturmschäden. *Merkbl. Prax., WSL* **17**: 6.
- Schönenberger W. & Wasem U. (1999): Der Beginn der Wiederbewaldung von Sturmwurfflächen im Gebirge - Ein Zwischenbericht. *Forstl. Forsch.ber. München* **176**: 102-110.
- Schweizerische Gebirgswaldpflegegruppe (1998): Waldwirkungen und Steinschlag. In: Rahphael Schwitter (ed.) *Dokumentation der 14. Arbeitstagung der GWG mit der FAN*. WSL, Grafenort / Engelberg OW.
- Senn J. (1999): Tree mortality caused by *Gremmeniella abietina* in a subalpine afforestation in the central Alps and its relationship with duration of snow cover. *Eur. J. For. Pathol.* **29**: 65-74.
- Shao G., Shugart H.H. & Smith T.M. (1995): A role-type model (rope) and its applications in assessing climate change impacts on forest landscapes. *Vegetatio* **121**: 135-146.
- Silvertown J. & Dodd M. (1999): The demographic cost of reproduction and its consequences in balsam fir (*Abies balsamea*). *Am. Nat.* **154**(3): 321-332.
- SLF (2000): *Der Lawinenwinter 1999: Ereignisanalyse*. Swiss Federal Institute for Snow and Avalanche Research, Davos. 588 p.
- Stage A.R. & Wyckoff W.R. (1998): Adapting distance-independent forest growth models to represent spatial variability: Effects of sampling design on model coefficients. *For. Sci.* **44**(2): 224-238.
- Starfield A.M. & Chapin F.S. (1996): Model of transient changes in arctic and boreal vegetation in response to climate and land use change. *Ecol. Appl.* **6**(3): 842-864.
- Sterba H., Blab A. & Katzensteiner K. (2002): Adapting an individual tree growth model for Norway spruce (*Picea abies* L. Karst.) in pure and mixed species stands. *For. Ecol. Manage.* **159**(1-2): 101-110.
- Sterba H., Golser M., Schwiger J. & Hasenauer H. (1997): Modelle für das Ankommen und das Wachstum der Naturverjüngung. *Cent.bl. gesamte Forstwes.* **1**: 11-33.
- Sterba H., Korol N. & Rossler G. (2001): Preliminary evaluation of an individual tree growth model for Norway spruce stands. *Forstwiss. Cent.bl.* **120**(6): 406-421.
- Sterba H. & Monserud R.A. (1997): Applicability of the forest stand growth simulator PROGNAUS for the Austrian part of the Bohemian Massif. *Ecol. Model.* **98**(1): 23-34.
- Takada T. & Nakashizuka T. (1996): Density-dependent demography in a Japanese temperate broad-leaved forest. *Vegetatio* **124**: 211-221.
- Tolvanen A., Schroderus J. & Henry G.H.R. (2001): Age- and stage-based bud demography of *Salix arctica* under contrasting muskox grazing pressure in the High Arctic. *Evol. Ecol.* **15**(4-6): 443-462.
- Urban D.L., Bonan G.B., Smith T.M. & Shugart H.H. (1991): Spatial applications of gap models. *For. Ecol. Manage.* **42**: 95-110.

- Usher M.B. (1981): Modelling ecological succession, with particular reference to markovian models. *Vegetatio* **46**: 11-18.
- Van Hulst R. (1979): On the dynamics of vegetation: Markov chains as models of succession. *Vegetatio* **40**: 3-14.
- Vanclay J.K. (1994): *Modelling forest growth and yield: applications to mixed tropical forests*. CAB International, Wallingford.
- Vanclay J.K. (1995): Growth models for tropical forests - a synthesis of models and methods. *For. Sci.* **41**(1): 7-42.
- Volin V.C. & Buongiorno J. (1996): Effects of alternative management regimes on forest stand structure, species composition, and income: A model for the Italian Dolomites. *For. Ecol. Manage.* **87**(1-3): 107-125.
- Waggoner P.E. & Stephens G.R. (1970): Transition probabilities for a forest. *Nature* **225**: 1160-1161.
- Walcher J. & Kupferschmid A.D. (2001): Borkenkäfer-Schadenflächen bei Schwanden. In: Thomas Rageth (ed.) *Binding Preis für vorbildliche Waldpflege 2001: Vivian als Chance. Gemeinde Schwanden GL*. Sophie und Karl Binding Stiftung, Basel. 43-45.
- Waldrop T.A., Buckner E.R., Shugart H.H. & Mcgee D.F. (1986): FORCAT: a single tree model of stand development following clearcutting on the Cumberland Plateau. *For. Sci.* **32**(2): 297-317.
- Wasser B. & Frehner M. (1996): *Wegleitung Minimale Pflegemassnahmen für Wälder mit Schutzfunktion*. Bundesamt für Umwelt, Wald und Landschaft (BUWAL), Bern. 40 p + Anhang.
- Wermelinger B. (2000): Wie viele Borkenkäfer überleben den Winter? *Inf.bl. Forsch.bereiches Wald* **2**:7.
- Wermelinger B., Duelli P., Obrist M., Odermatt O. & Seifert M. (1995): Die Entwicklung der Fauna auf Windwurfflächen mit und ohne Holzräumung. *Schweiz. Z. Forstwes.* **146**(11): 913-928.
- Wermelinger B., Obrist M.K., Duelli P. & Forster B. (1999): Development of the bark beetle (Scolytidae) fauna in windthrow areas in Switzerland. *Mitt. Schweiz. Entomol. Ges.* **72**: 209-220.
- West C.J. (1995): Sustainability of *Beilschmiedia-tawa*-dominated forest in New-Zealand - population predictions based on transition matrix model analysis. *Aust. J. Bot.* **43**(1): 51-71.
- Yemshanov D. & Perera A.H. (2002): A spatially explicit stochastic model to simulate boreal forest cover transitions: general structure and properties. *Ecol. Model.* **150**(1-2): 189-209.

VII APPENDIX

VII A Microsite types

Definition

The 26 microsite types were defined for the entire Gandberg forest according to the following criteria:

- the dominant plant or moss species
- the associated soil surface characteristics (i.e. stones and boulders vs. raw humus, mull, etc.), or
- the decomposition stage of woody debris (i.e. woody microsite types in Tab. 1).

Exceptions were made if raspberry and / or ferns were present. When these plants dominated a site so strongly that no moss cover was found, the microsite types were ‘Rubus’ or ‘Fern’. However, if moss cushions were present, the microsite types were defined as ‘MossRubus’ or ‘MossFern’. In the case that both *Rubus* and ferns were present, the area was assigned to the microsite type ‘FernRubus’, thereby it was unimportant if moss cushions were present or absent (cf. Table 1). Furthermore, stones and boulders without plants or mosses were considered as ‘Boulders’, while stones and boulders overgrown with mosses were defined as ‘MossBoulder’ (cf. Table 1).

Trees were only considered as dominant plants if they had reached a minimum height of 1.3 m (i.e. average height of *Rubus idaeus*), regardless of the surrounding vegetation. This procedure was used to ensure an equal treatment of all individual trees on the 26 microsite types. Otherwise, areas with saplings and without vegetation (e.g. ‘Soil’, ‘Boulder’) or those covered with saplings and low plants or mosses would have been assigned to the microsite types ‘Picea’, ‘Betula’, ‘Sorbus’ and ‘Acer’ (cf. pictures of ‘Oxalis’, ‘Soil’ and ‘Boulder’ microsite types in Fig. 1), whereas areas with saplings under *Rubus*, ferns, *Sambucus* etc. would have been assigned to the corresponding plant microsite types (cf. picture of the ‘Rubus’ microsite type in Fig. 1). Such an unequal treatment would impede a simple comparison between (i) the frequencies of the observed microsite types, and (ii) the field sampling and model simulations (cf. comparison of microsite frequencies in chapter IV B and C).

Table 1: Abbreviations and definitions of microsite types used in the ‘RegSnag’ model. To implement all non-woody microsite types in the model, an array called ‘Vege[microsite]’ is used in the STELLA® software (cf. chapter VII B).

Abbreviations of microsite types	
Woody microsite types	
Tree	Living tree; mostly <i>Picea abies</i> , <i>Abies alba</i> <i>Acer pseudoplatanus</i> or <i>Betula pendula</i>
Snag	Dead standing <i>Picea abies</i> tree
Stump	Rest of broken snag = stump
CWD	Coarse woody debris = rotten stumps, logs and branches
Log	Lying tree = log
Branch	Accumulations of branches and bark pieces
Timber	Hanging logs = logs without full soil contact on their whole length
Non-woody or vegetated microsite types	
Boulder	Stones and boulders without a cover of mosses or plants; mostly Verrucano, i.e. read conglomerate
Microsite types included in the array ‘Vege’	
Soil	Bare soil, raw humus, needles
Oxalis	dominated by <i>Oxalis acetosella</i>
Root	Roots of trees, snags and stumps not yet rotten
MossBoulder	Mosses that cover boulders (except very dense cushions of <i>Polytrichum</i> and <i>Hylocomium</i> , which were classified as ‘Poly’ and ‘Hylo’)
Poly	dominated by <i>Polytrichum formosum</i> or <i>Polytrichum alpinum</i> cushion (few scattered individuals of <i>Galeopsis tetrahit</i> , <i>Oxalis acetosella</i> , <i>Epilobium montanum</i> , <i>Circaea alpina</i> , <i>Carex sp.</i> and <i>Galium rotundifolium</i> may be present too)
Hylo	dominated by <i>Hylocomium splendens</i> or <i>Thuidium tamariscinum</i> cushion
Moss	dominated by other mosses; at the subalpine level, mostly <i>Sphagnum cf. quinquefarion</i> and at the montane level mostly liverworts
Fern	dominated by ferns; mostly <i>Dryopteris dilatata</i> , <i>D. filix-mas</i> , but also <i>Oreopteris limbosperma</i> and <i>Athyrium filix-femina</i> or small ferns like <i>Gymnocarpium dryopteris</i> and <i>Phegopteris connectilis</i> (with or without undergrowth of other plants like <i>Epilobium angustifolium</i> or <i>Oxalis acetosella</i> , but without mosses)
Rubus	dominated by <i>Rubus idaeus</i> (with or without undergrowth of other plants like <i>Epilobium angustifolium</i> or <i>Oxalis acetosella</i> , but without mosses)
MossRubus	Mosses under <i>Rubus idaeus</i>
MossFern	Mosses under ferns
WD	Woody debris = CWD including the area of rotten roots
FernRubus	Fern under <i>Rubus idaeus</i> (with or without undergrowth of other plants and mosses)
Grass	dominated by grasses; mostly <i>Calamagrostis villosa</i> , but also <i>Carex sp.</i> and <i>Avenella flexuosa</i> on the montane level
Othervege	dominated by other herbs (with or without undergrowth of moss cushions); at the subalpine level mostly <i>Vaccinium myrtillus</i> and at the montane level mostly <i>Senecio ovatus</i> , <i>Galium ovatum</i> , <i>Galeopsis tetrahit</i> and <i>Epilobium montanum</i> (could not be named Vege due to the array name)
Sambucus	dominated by <i>Sambucus racemosa</i> (with or without undergrowth of other plants and moss cushions)
Betula	dominated by <i>Betula pendula</i> with a height > 1.3 m
Sorbus	dominated by <i>Sorbus aucuparia</i> with a height > 1.3 m
Picea	dominated by <i>Picea abies</i> with a height > 1.3 m
Acer	dominated by <i>Acer pseudoplatanus</i> with a height > 1.3 m

Assignment of microsite types during field work

In the field sampling, a microsite had to cover at least an area of about 10 cm x 10 cm to be distinguished from a surrounding microsite type or from adjacent microsite types. For example, a small piece of bark was not considered as microsite type 'Bark', but large bark pieces or accumulations of bark litter were considered as microsite type 'Bark'.

Tree seedlings and saplings were assigned to a microsite type after having evaluated the microsite type in a circular area with a diameter of about 1/2 of the height of the saplings, but at least of 20 cm (cf. Fig. 1).

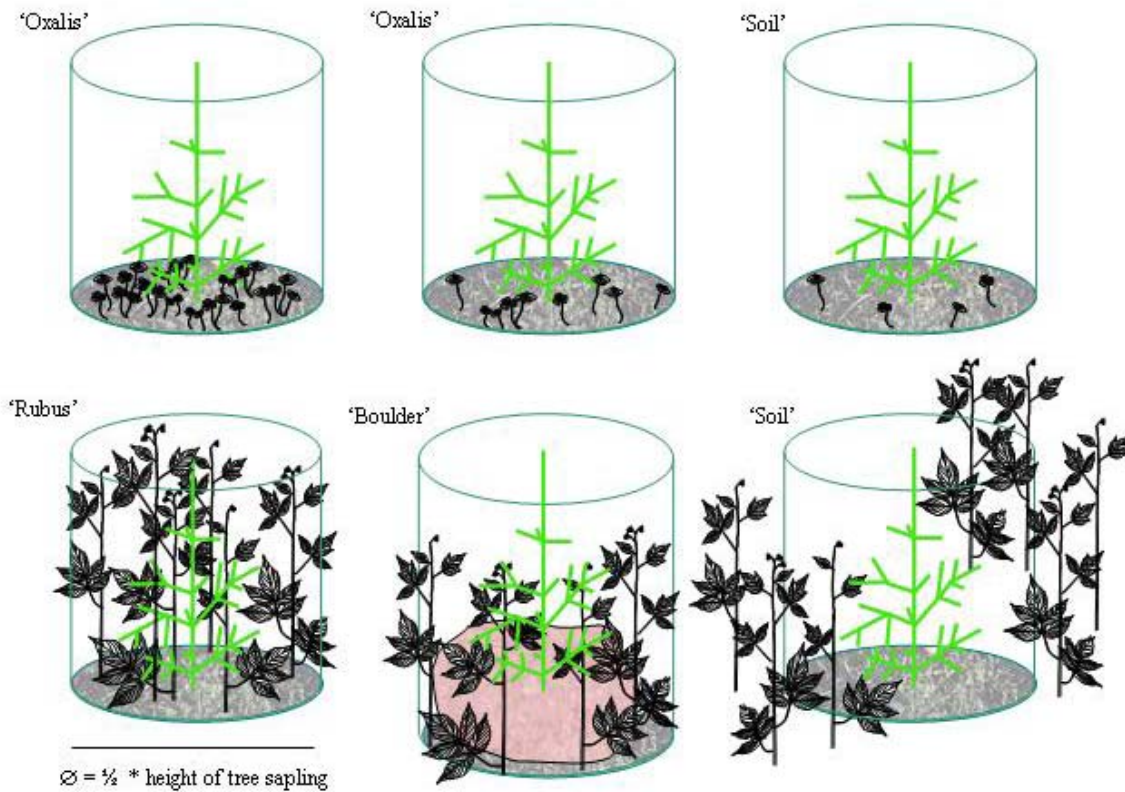

Figure 1: Examples of six *Picea abies* saplings assigned to four different microsite types. The green cylinders represent the area in which (i) the dominant plant, (ii) the soil surface characteristic and (iii) the decomposition stage of woody debris were considered during the microsite type assignment.

VII B Short description of the simulation model 'RegSnag'

The model RegSnag (described in chapter IV C) is reproduced on the attached CD, implemented with the parameters and initial values for the montane elevational level. Details about the parameter estimation and the initial values used in the decay and vegetation module are discussed in chapter IV B, while those used in the tree regeneration module and the link between the modules are described in chapter IV C.

The RegSnag model consists of different modules which were divided themselves into different sectors (boxes in the STELLA® software, Fig. 1). The elements of the decay module are coloured in brown, the elements of the ground-vegetation module in red, and the elements of the tree regeneration module in pink, violet, blue or green. The different colours used in the tree regeneration module have the following meaning: seed input (pink), germination (violet), number of trees (blue) and height of trees (green). The part linking the tree regeneration and the vegetation module is coloured in orange (Fig. 1).

Details of the single elements or sectors of the RegSnag model (Fig. 1) are explained in Figs. 2-11, while the abbreviations used in the model are listed in Table 1 of chapter VII A (microsite types) and Table 1 of this chapter (parameters). Only the most necessary knowledge about the STELLA® software (High Performance Systems 2001) is explained. For a general introduction into this software I refer to Hannon and Ruth (1997) and to the help menu implemented in the STELLA® 7.0.1 software (High Performance Systems 2001).

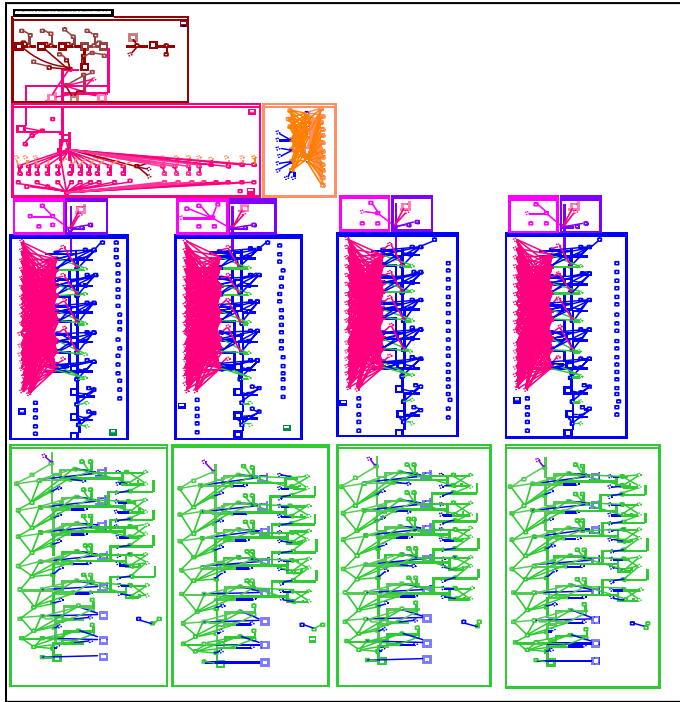

Fig. 1: Scheme of the RegSnag model implemented with the STELLA® software. Description see text and figures 2-12.

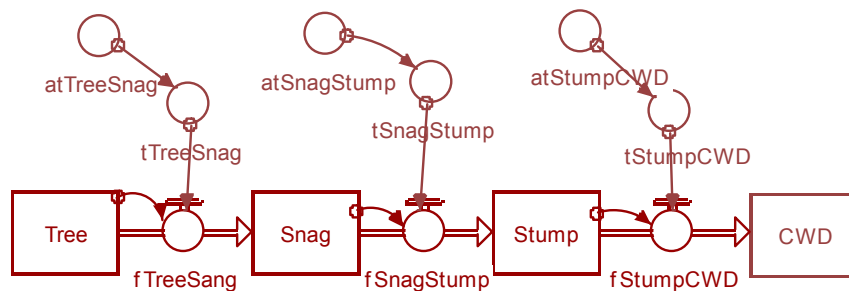

Fig. 2: Decay chain of a tree as visualized in the STELLA® software. It starts with a living tree defined in the model as state 'Tree'. All states are called stocks in the STELLA® software and are symbolised with quadrates. When the living tree dies, it becomes with the rate 'atTreeSnag' a snag (= a dead standing tree). As listed in the abbreviations in Table 1, the first a in 'atTreeSnag' means an annual rate. 'atTreeSnag' is changed into a weekly rate in the converter 'tTreeSnag' (calculation see chapter IV C, equation 2). Finally, 'fTreeSang' stands for the flow from the stock 'Tree' to the stock 'Snag', i.e. the amount in 'Tree' is multiplied by 'tTreeSnag', resulting in the area which changes during one time step (one week) from 'Tree' into 'Snag'. The rest of the decay chain is calculated in a similar way.

Table 1: Abbreviations used in the RegSnag model implemented with the STELLA® software. Abbreviations of microsite types are listed in Table 1 chapter VII A.

Abbreviation	Definition
General abbreviations	
<i>year</i>	<i>Time count</i>
<i>a</i>	<i>Annual parameter</i>
<i>c</i>	<i>Constant parameter</i>
<i>v</i>	<i>Variable</i>
<i>s</i>	<i>Stock, in case of heights of trees</i>
<i>t</i>	<i>Transition probability between microsite types</i>
<i>g</i>	<i>Germination rate of trees</i>
<i>m</i>	<i>Mortality rate of trees</i>
<i>r</i>	<i>Height increment of trees</i>
<i>b</i>	<i>Browsing rate of trees</i>
<i>f</i>	<i>Flow from a microsite type into another microsite type</i>
<i>n</i>	<i>Number of trees</i>
<i>h</i>	<i>Height of trees</i>
<i>in resp. out</i>	<i>Flow in resp. out of a state (used for changes from one state to another state within an array)</i>
<i>sum</i>	<i>Summation of parameters, states etc.</i>
<i>max</i>	<i>Maximum height in a class</i>
<i>min</i>	<i>Minimum height in a class</i>
Abbreviations of tree species	
<i>S</i>	<i>Sorbus aucuparia L.</i>
<i>B</i>	<i>Betula pendula Roth.</i>
<i>P</i>	<i>Picea abies (L.) Karst.</i>
<i>A</i>	<i>Acer pseudoplatanus L.</i>
Abbreviations of height classes	
<i>0</i>	<i>Class between seeds and first height class (first summer)</i>
<i>1</i>	<i>Height class 1: 4-10.0 cm</i>
<i>2</i>	<i>Height class 2: 10.1-20.0 cm</i>
<i>3</i>	<i>Height class 3: 20.1-40.0 cm</i>
<i>4</i>	<i>Height class 4: 40.1-70.0 cm</i>
<i>5</i>	<i>Height class 5: 70.1-130.0 cm</i>
<i>6</i>	<i>Height class 6: 130.1-250.0 cm</i>
<i>7</i>	<i>Height class 7: 250.1-500.0 cm</i>
<i>8</i>	<i>Height class 8: >500 cm</i>

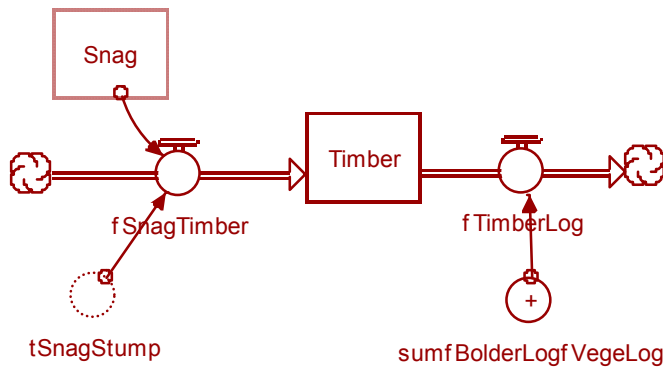

Fig. 3: Calculation of the amount of hanging trees ‘Timber’. Dashed symbols are copies (so called ghosts) of the real stocks or converters in order to clearly arrange the scheme in STELLA®. As mentioned in chapter IV B, ‘Timber’ is produced with the same rate as ‘Snag’ changes into ‘Stump’, but multiplied with the area correction factor 36. This is done here by calculating $36 * tSnagStump * Snag$ in the flow ‘fSnagTimber’. ‘fTimberLog’ is equal to ‘sumfBolderLogfVegeLog’, which is the sum of the area that changes from ‘Boulder’ into ‘Log’ and from the array ‘Vege’ into ‘Log’ during one time step. ‘Vege’ is a vector and contains all microsite types which are more or less suitable for tree regeneration (see Table 1, chapter VII A).

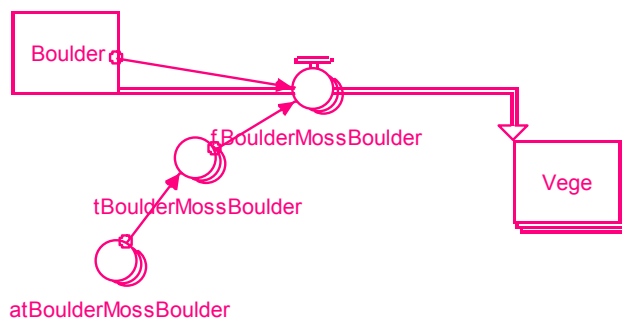

Fig. 4: Similar to the decay process, ‘Boulder’ changes into the microsite type ‘MossBoulder’ which is implemented as a part of the vector ‘Vege’.

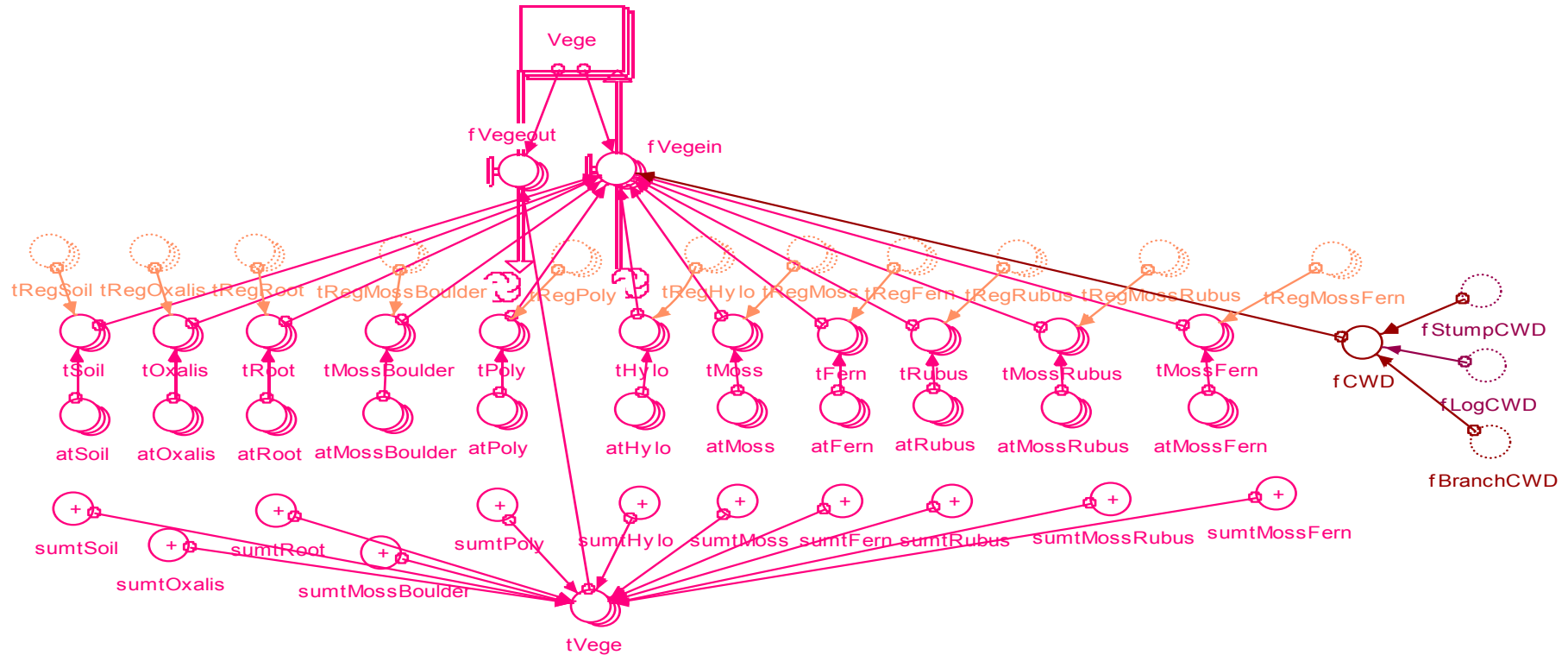

Fig. 5: Section of the microsite matrix part of the model RegSnag. The STELLA® software does not enable the implementation of a transition matrix between stages. However, the microsite matrix of the ground-vegetation model (chapter IV B) was organised in STELLA® with arrays of converters, i.e. vectors containing the values in the columns of the matrix (e.g. 'tSoil', 'tOxalis', etc.). The multiplication between the vector 'Vege' and the matrix (here implemented with these 'tMicrosites') was carried out with the help of the flows 'fVegeout' and 'fVegein'. For example, when 'Soil' changes with the probability 'tSoil[Moss]' into 'Moss', the 'fVegeout' deducts 'Soil' by 'tSoil[Moss]*'Soil', while 'fVegein' increases 'Moss' by the same amount. To simplify the outflows, the sum of each total outflow is calculated per microsite type, by setting the self-replacement probabilities to 0, and by summing up the rest of the transition matrix columns in the 'sumtMicrosite' converters. The last is centralised in 'tVege', so that 'fVegeout' becomes 'tVege[Microsite]*'Vege[Microsite]'. An exception is the microsite 'WD' which is directly calculated from the flows 'fStumpCWD', 'fLogCWD' and 'fBranchCWD' that are themselves calculated in the decay module. The orange coloured transitions are used to account for the areas which have to change into 'Betula', 'Sorbus', 'Picea' or 'Acer' (calculation see below).

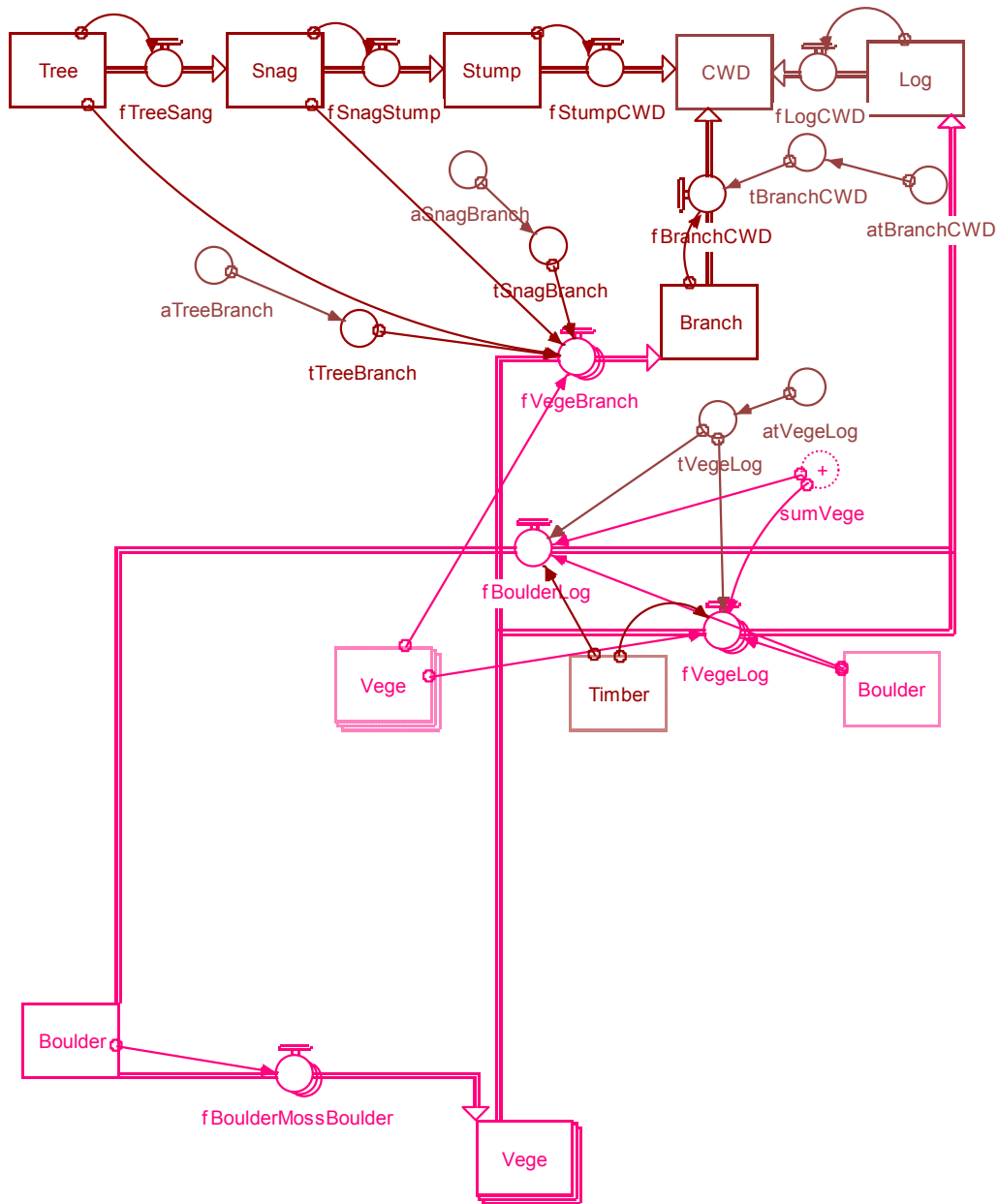

Fig. 6: Link between decay and ground-vegetation modules. The amount of branches and logs which are created during the decay process are calculated in the decay module. The transition probability from 'Timber' to 'Log', which was estimated in chapter IV B, was used as 'atVegeLog', because it defines the proportion of area which changes from 'Boulder' and all microsite types in the vector 'Vege' to 'Log'. It is assumed that the area which is newly covered by logs reduces the cover of these microsite types in proportion to their occurrence at a given time step; 'fVegeLog' = $(tVegeLog * Timber) / 100 * (Vege[Microsite] / (sumVege + Boulder) * 100)$. The area of 'Branch' is calculated by multiplying the 'Tree' and 'Snag' by the area correction factor 5 and the specific rates describing the loss of branches of trees and snags (e.g. 'tTreeBranch' and 'tSnagBranch'). This area newly covered with branches reduces in contrast to 'Log' only the area covered by 'Roots', 'Soil', 'Oxalis' and to a lesser extent (1/3) also the three moss microsite types. This is implemented in 'fVegeBranch'.

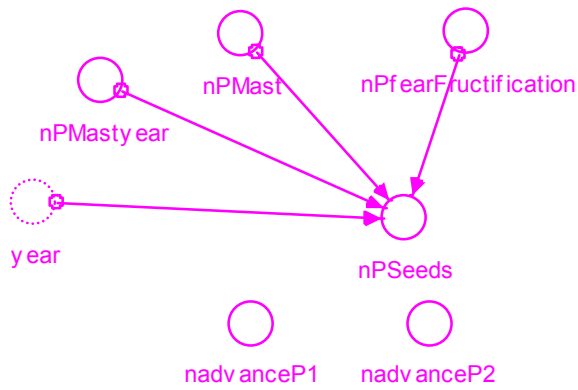

Fig. 7: Seed input of *Picea abies*. In week 51 of the first year, a seed input due to an extraordinary seed production is assumed (chapter IV C), which is here called 'nPfearFructification', n for number of seeds, P for *Picea* (see Table 1). The binary variable 'nPMasty ear' defines with a certain probability but at random if a year is a good seed year (1) or not (0). This is implemented with the function Montecarlo(probability) of the STELLA® software. 'nPMast' gives the maximum number of seeds produced in a mast year, and year is a counter for the weeks within each year. It is used in 'nPSeeds' to make sure that only in week 51 of each year some seeds are released (chapter IV C). In mast years (i.e. 'nPMasty ear' = 1), a random number between $0.5 * \text{'nPMast'}$ and 'nPMast' is assumed, and in non mast years (i.e. 'nPMasty ear' = 0) a random number between 0 and $0.137 * \text{'nPMast'}$. This is calculated in 'nPSeeds'. 'nadvanceP1' and 'nadvanceP2' are the amounts of advance *Picea* regeneration in class 1 and 2, respectively.

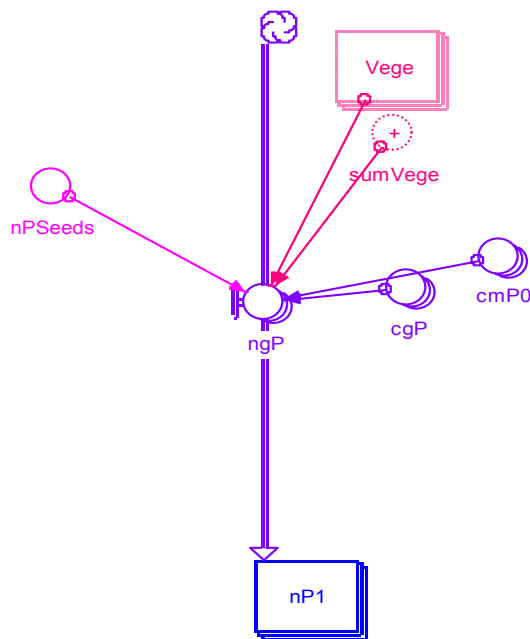

Fig. 8: Number of germinated *Picea abies* seeds: The number of seeds produced ('nPSeeds') is divided between the microsite types according to their occurrence at each time. The amount of seedlings that enter 'nP1' (= number of seedlings and saplings in height class 1) depends on the germination rates which are specific for each microsite type ('cgP[Microsite]') and the mortality rates between the germination date and the first summer ('cmPO[Microsite]').

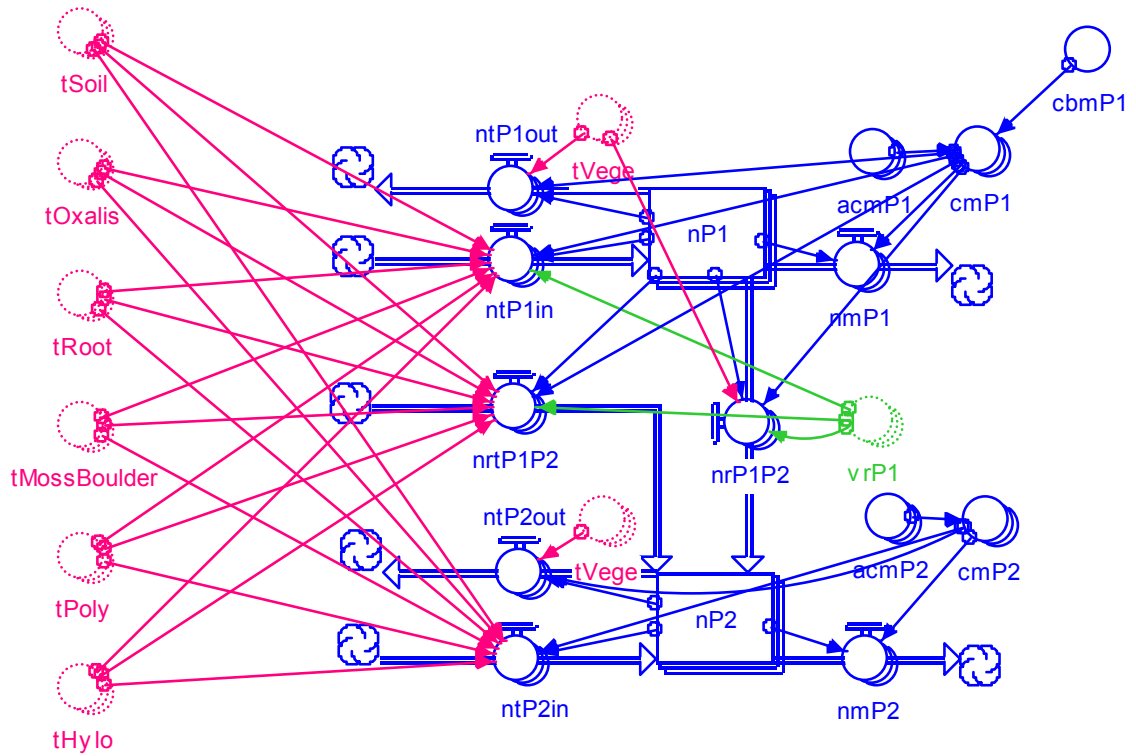

Fig. 9: Number of *Picea abies* seedlings and saplings in each height class and microsite type. The number of *Picea* in height class 1 ('nP1[Microsite]') is managed for all microsite types included in the vector 'Vege'. Trees have a certain probability to die 'cmP1[Microsite]' which is composed of a microsite-specific mortality rate 'acmP1[Microsite]' and a browsing mortality rate 'cbmP1'. Furthermore, trees change their microsite type with the same probability as the microsite itself does change (chapter IV C). This is implemented again with outflows and inflows (e.g. 'ntP1out[Microsite]' and 'ntP1in[Microsite]') of the vector 'nP1[Microsite]'. However, trees can also grow and therefore the outflow equals the number of trees which change the microsite type without growing into a higher height class ('ntP1in[Microsite]') and the number of trees which change both microsite type and height class ('nrtP1P2[Microsite]'). In addition, trees can remain in the same microsite type, but grow into the next class, which is calculated with the flow 'nrP1P2[Microsite]', that is:

'nrP1P2' = 'vrP1[Microsite]' * 'nP1[Microsite]' * (1 - 'cmP1[Microsite]') * (1 - 'tVege[Microsite]'), where vrP1[Microsite] is the growth rate of the trees which is calculated in the section height of trees (see below).

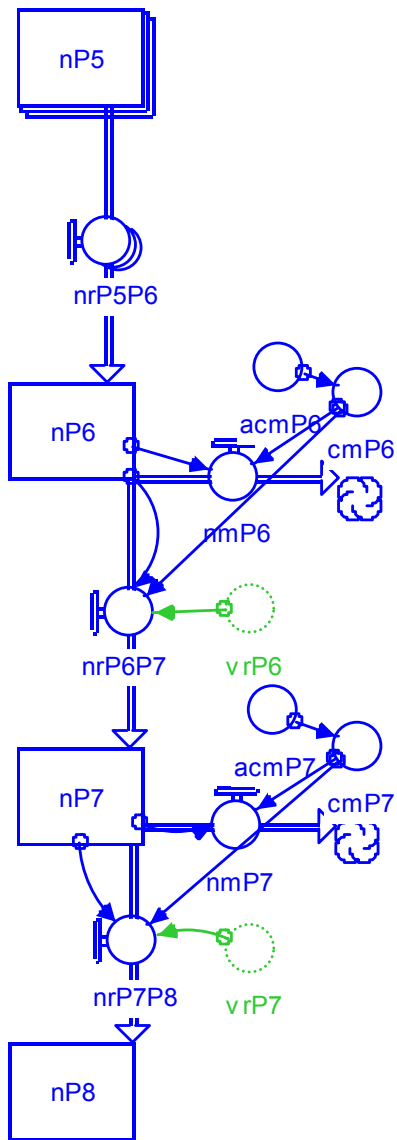

Fig. 10: Number of *Picea abies* per height class. From the height class 6 till height class 8, only average height increments and mortality rates are assumed (chapter IV C) and therefore no outflows and inflows are necessary to calculate the amount of trees per height class. As the model RegSnag is developed to project the amounts of tree regeneration, but not to simulate a whole tree life, the height class 8 is an absorbing state, i.e. trees which reach 5 m height do neither grow further nor die.

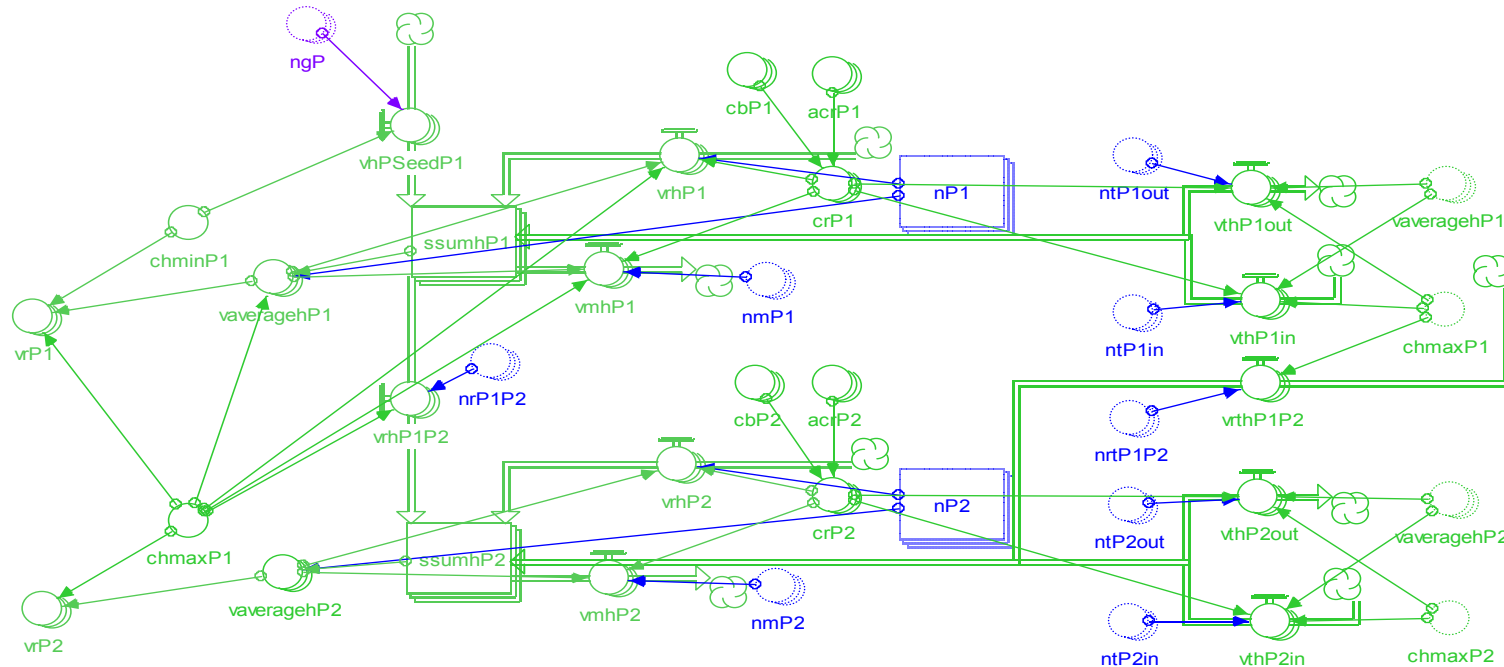

Fig. 11: Average height of *Picea abies* per height class and microsite type: New *Picea* seedlings enter the first height class with the minimum height a tree can have (e.g. defined in chapter IV C as 4 cm). Hence the number of newly germinated seeds ‘ngP’ increases the sum of all tree heights in class 1 ‘ssumhP1’ by ‘ngP’*‘chminP1’. When trees grow, the sum of the heights in their class (e.g. ‘ssumhP1’) is increased by ‘vhP1’, which is a function of the height increment (‘crP1’) and the amount of trees in the class (‘nP1’). The height increment itself (‘crP1’) is calculated with the annual height increment ‘acrP1’ multiplied by the proportion of unbrowsed trees (1-browsing rate ‘cbP1’) and divided by 52 (cf. a year contains 52 weeks). When a tree dies, it reduces the total sum of heights in its class by the average height of that class (cf. calculated in ‘vmhP1’). Similarly, when a tree changes its microsite type, it moves its height to the other microsite type, which is calculated with the outflows and inflows ‘vthP1out’ and ‘vthP1in’. Finally, when a tree changes height class, it reduces the sum of the heights in its former height class on a certain microsite type (e.g. ‘ssumhP1[Microsite]’) by the maximum height of the class (‘chmaxP1’) and increases by the same amount the height sum of the new class (e.g. ‘ssumhP2[Microsite]’). This is calculated in ‘vrhP1P2[Microsite]’ and ‘vrthP1P2[Microsite]’. With the resulting total sum of heights in a class, the average tree height in the class (‘vaveragehP1’) is simply calculated by dividing the ‘ssumhP1’ by ‘nP1’. Ultimately, the growth rate ‘vrP1[Microsite]’ of this class can be calculated using equation 1 described in chapter IV C, i.e.: ‘vrP1’ = ‘vaveragehP1[Microsite]’ - ‘chminP1’) / (‘chmaxP1’ - ‘chminP1’))^20).

The procedure used for calculating numbers and heights of *Picea abies* seedlings and saplings is likewise used for the other tree species (*Betula pendula* (B), *Sorbus aucuparia* (S) and *Acer pseudoplatanus* (A), cf. Fig. 1).

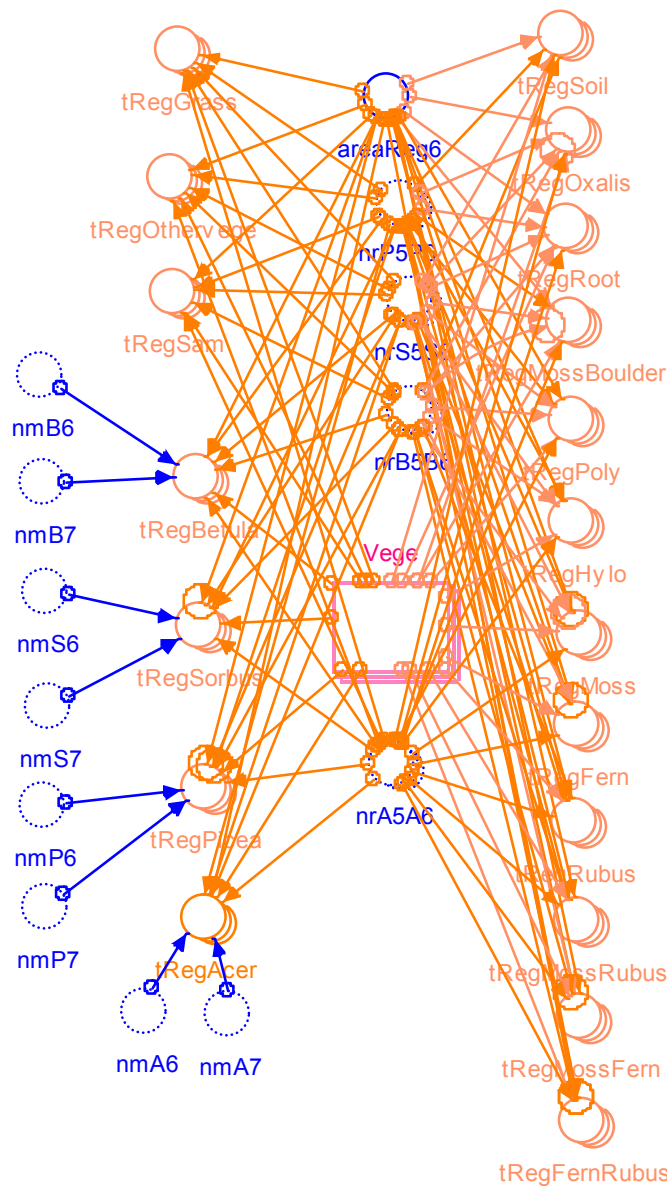

Fig. 12: Link between tree regeneration and microsite modules. In this sector the transitions from microsite types dominated by ground-vegetation, roots and coarse woody debris (microsite types in the vector ‘Vege’) into tree dominated microsite types (‘Picea’, ‘Sorbus’, ‘Betula’ and ‘Acer’) are calculated. These transitions occur when the trees get larger than 1.3 m, i.e. when they change into height class 6. The amount of trees which change into class 6 (e.g. ‘nrP5P6’) is multiplied by the area a tree of this height occupies, i.e. by ‘areaReg6’ (e.g. 0.5 m², see chapter IV C) and divided by the microsite frequency (because tRegMicrosite is again multiplied by the microsite in fVegein[Microsite] of the ground-vegetation module, cf. Fig. 5). If a tree in height class 6-8 dies, the area it occupies changes into ‘Soil’. Both the transitions into tree dominated microsite types and into soil are implemented in these ‘tRegMicrosites’.

VII C Short description of the decay and vegetation succession model

This model is similar to the decay and ground-vegetation module of the RegSnag model (Fig. 2-6 of chapter VII B). However, as the amount and height of trees are not modelled explicitly, simple transition probabilities from microsite types in the vector ‘Vege’ into ‘Sorbus’, ‘Betula’ and ‘Picea’ are estimated (Fig. 1), while *Acer* is neglected. Details see chapter IV B.

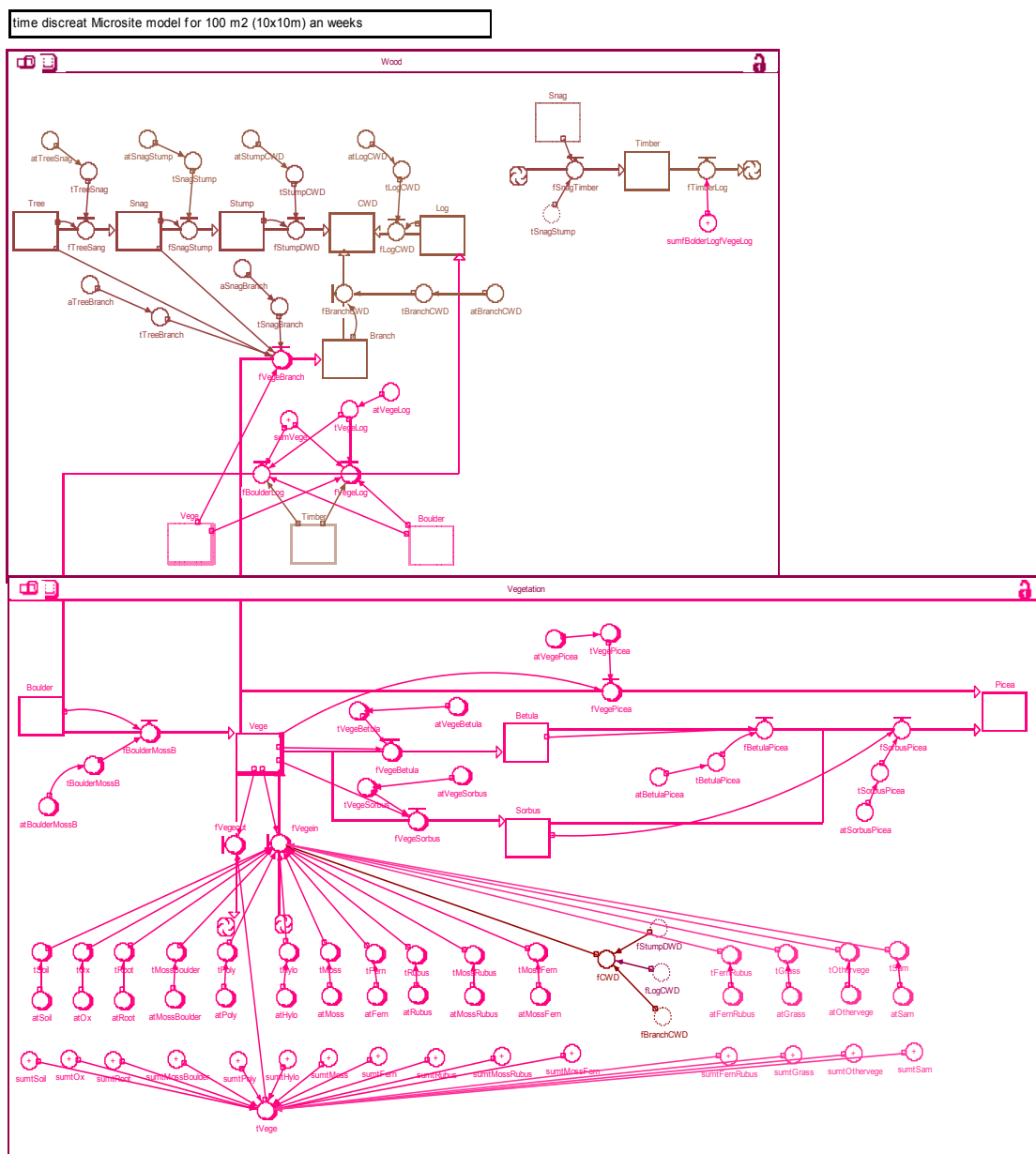

Fig. 1: Scheme of the decay and ground-vegetation model used in chapter IV B.

Curriculum vitae

Andrea Doris Kupferschmid Albisetti

born on 5 November 1973 in Luzern, Switzerland
citizen of Sumiswald BE and Meride TI, Switzerland

1981-1985: Primary school in Biel/Bienne

1985-1989: High school in Biel/Bienne

1989-1994: College in Biel/Bienne, Matura in Economy

1994-1999: Studies of vegetation science at the University of Bern and Neuenburg
Diploma thesis:
<Dispersal and microsite limitation in an abandoned calcareous grassland on Monte San Giorgio>

1996-1999: Diploma as a biology teacher at college level

1996-2000: Subsidiary studies in Geology at the University of Bern

1999-2000: Assistant at the Swiss Federal Institute of Technology Zürich (ETH),
Department of Forest Sciences, Institute of Wood Science

2000-2003: Ph.D thesis at the Swiss Federal Research Institute WSL, section
Silvicultural Strategies and at the ETH Zürich, Institute of Mountain
Forest Ecology
<Succession in a protection forest after *Picea abies* die-back>

2001-2003: Post-graduate course in statistics at the ETH Zürich

current address:

Andrea D. Kupferschmid Albisetti
Fadacherstr. 17
CH-8340 Hinwil

permanent E-Mail address:

andrea.d.kupferschmid@alumni.ethz.ch