

Collision avoidance using a model of the locust LGMD neuron

Report**Author(s):**

Blanchard, Mark; Verschure, Paul F.M.J.

Publication date:

2001

Permanent link:

<https://doi.org/10.3929/ethz-a-004266422>

Rights / license:

[In Copyright - Non-Commercial Use Permitted](#)

Originally published in:

INI's posters

Collision avoidance using a model of the locust LGMD neuron



Mark Blanchard, Paul F.M.J. Verschure
 Laboratory of Neuromorphic Robotics and Synthetic Epistemology (LNRSE)
 Institute of Neuroinformatics, University/ETH Zürich, Winterthurerstrasse 190, CH-8057 Zürich
 www.ini.unizh.ch



Introduction 1

- The visual systems of insects perform complex processing using remarkably compact neural circuitry.
- Many large motion-sensitive neurons have been identified in different species of insect but their input circuitry is often poorly understood.
- Modelling studies can help us to investigate hypotheses on this circuitry and its function.
- By implementing these models on robots we can investigate their responses in the real world.

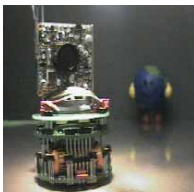

Model circuit 4

- Using IQR421 we have designed a model of the input circuitry to the LGMD.
- This circuit was connected to a wide-angle monochrome camera mounted onto the mobile robot Khepera.
- The overall simulation consisted of 7000 neurons and 24,000 synapses and ran in real-time.
- The simulation ran on two Pentium II Linux PCs and comprised three interconnected processes.

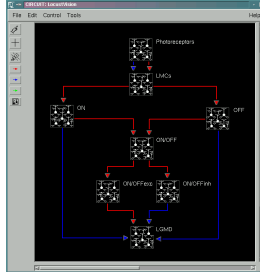

Tracking LGMD responses 7

- We evaluated the properties of the LGMD model by investigating its behavioural implications for the robot.
- The robot explored a secluded space (dot-world) where the walls were covered with high-contrast circles.
- Simultaneously we sampled the responses of the LGMD neuron and the positions visited by the robot.
- This allows us to determine which avoidance actions of the robot were triggered by the LGMD cell.
- This behaviour was evaluated in a trial which lasted for 10000 time steps, corresponding to approximately 11 minutes of actual time.
- An estimated 80% of avoidance responses were due to activity in the LGMD.

Project goals 2

- Our study of insect vision has three main aims:
 - to develop models of independent pathways of processing which respond to different visual features.
 - to investigate how the information from several pathways can be integrated to produce behaviour.
 - to produce artificial devices capable of navigating through the real world using vision.
- We are using the LGMD system of the locust as one of our starting points.

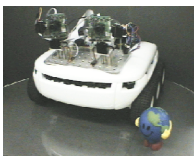

5

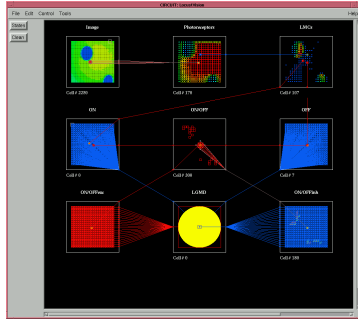

8

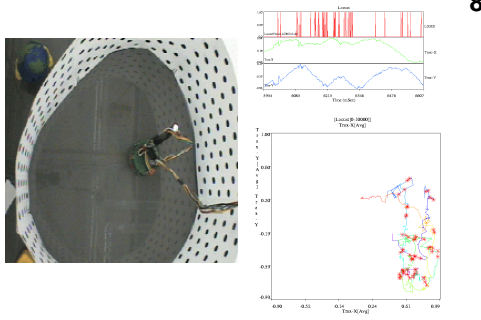

The locust LGMD neuron 3

- The lobula giant movement detector (LGMD) is a large neuron in the optic lobe of the locust.
- Over the past forty years extensive research has been conducted to investigate the LGMD's responses and function.
- Approaching objects produce the strongest responses from the LGMD suggesting a role in detecting potential collisions.
- The neural circuit which produces these responses has not yet been identified fully.

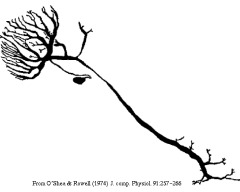

From O'Shea & Rind (1971) J. comp. Physiol. 91:237-268

Responses of the model 6

- The monochrome image derived from the camera sets the membrane potential of the 400 model photoreceptors.
- Using a combination of linear-threshold and integrate-and-fire cells, the moving edges within the scene are extracted.
- Approaching objects are detected by a combination of rapid direct excitation and delayed lateral inhibition.
- The spike-rate of the LGMD cell triggers an avoidance reflex in the robot.

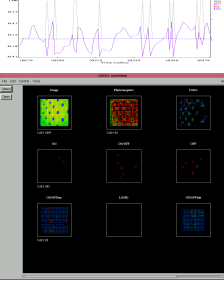

Conclusions 9

- Our preliminary results show that a model which is accurately reflecting basic properties of the LGMD neuron and its afferent circuitry produces robust visually-guided avoidance behaviour on a mobile robot.
- In subsequent work we will investigate more closely the detailed response properties of this model and its ability to respond in more natural environments.
- We will also extend our study of insect vision to explore other motion-detecting pathways using our neuromorphic robotics approach.

The authors acknowledge the contributions of Dr. F. Clivio Riedl, Newcastle University, UK, for providing the biological background of the present model, and Jörg Conradt, TU Berlin, Germany for building zoab, shown in panel 2.