

Rover Chassis evaluation and design optimisation using the RCET

Conference Paper**Author(s):**

Michaud, Stéphane; Richter, L.; Thüer, Thomas; Gibbesch, A.; Huelsing, T.; Schmitz, N.; Weiss, S.; Krebs, Ambroise; Patel, N.; Joudrier, L.; Siegwart, Roland; Schäfer, B.; Ellery, A.

Publication date:

2006

Permanent link:

<https://doi.org/10.3929/ethz-a-010043426>

Rights / license:

[In Copyright - Non-Commercial Use Permitted](#)

ROVER CHASSIS EVALUATION AND DESIGN OPTIMISATION USING THE RCET

S.Michaud⁽¹⁾, L.Richter⁽²⁾, T.Thueer⁽³⁾, A.Gibbesch⁽⁴⁾, T.Huelsing⁽⁵⁾, N.Schmitz⁽²⁾, S.Weiss⁽²⁾, A.Krebs⁽³⁾,
N.Patel⁽⁷⁾, L.Joudrier⁽⁶⁾, R.Siegwart⁽³⁾, B.Schäfer⁽⁴⁾, A.Ellery⁽⁷⁾

⁽¹⁾Contraves Space AG
Schaffhauserstr. 580
CH-8052 Zurich
(Switzerland)
stephane.michaud@oerlikon.com

⁽²⁾DLR Institute of Space
Simulation
Linder Höhe
D-51147 Cologne
(Germany)

⁽³⁾Autonomous Systems Lab,
Swiss Federal Institute of
Technologies, Zurich
CH-8052 Zurich
(Switzerland)

⁽⁴⁾DLR Institute of Robotics
and Mechatronics
Oberpfaffenhofen
D-82234 Wessling
(Germany)

⁽⁵⁾EADS SPACE
Transportation
GNC & On-board S/W
Engineering 28199 Bremen
(Germany)

⁽⁶⁾European Space Agency
Automatic & Robotic
Section (TOSMMA)
P.O Box 229, 2200 AG
Noordwijk
(The Netherlands)

⁽⁷⁾University of Surrey
Surrey Space Center
Guildford, Surrey (U.K.)

ABSTRACT

A set of tools was developed in the frame of ESA activity [18191/04/NL] labelled RCET (Mars Rover Chassis Evaluation Tools) to support design, selection and optimisation of space exploration rovers. This activity was carried out jointly by Contraves Space as prime contractor, ETHZ, DLR, SSC and EADS Space Transportation. This paper describes the utilisation of the RCET in the context of a rover mission on Mars. The evaluation of the NASA MER and RCL-E rover chassis was done and the results are presented. This study includes wheel design optimisation on a particular soil, simulation of rover suspensions and rover comparison based on normalisation rules. With the experience gained in this study, a strategy for predicting locomotion performances was developed that allows an optimisation of both chassis configuration and motion control. The facilities and methodology used in the frame of this activity for validating the tools is also briefly presented.

INTRODUCTION

For future unmanned landing missions to solar system objects outside the Earth within the ESA programme, planetary rovers of different capabilities need to be studied, defined and ultimately developed for flight. Rovers have to achieve motion in rough and unknown terrain and have to do this partially autonomously. To do so, they need two important competencies which are all-terrain locomotion and autonomous navigation.

The RCET tools enable a user to design and develop an efficient and optimal configuration for a planetary exploration rover as far as the mobility aspect is concerned for a variety of terrains. The design can be evaluated at wheel level and at rover chassis level. The results can be analyzed and suitably modified to ensure correct and timely development of the flight model. The RCET consists of:

- A tractive prediction module (TPM) that handles the wheel ground interaction. The TPM can be used in a standalone mode for wheel evaluation and optimisation. Preliminary estimation of the rover chassis motion performance on a particular soil can also be achieved and is described in [2].
- 2D quasi static simulation (2DS) application dedicated to support the selection of a rover chassis concept at early design phase. The locomotion structure optimisation can be achieved in an iterative process. An optimal motion control algorithm was also implemented and is described in [5, 7, 8].
- Both tools are integrated in a database driven environment that allows post-processing the simulation data and simplified the reporting work as described in [4].
- Based on a CAD model, a full 3D multi-body simulation (3DS) can be performed in a representative Martian terrain. The 3D simulator includes the TPM.
- Two different testbeds were developed and built for characterisation of wheels and rover chassis from breadboard level up to FM. They were used in the RCET activity to experimentally validate aspects of the theoretical models. The first one is dedicated to a single-wheel characterisation and the second one for the rover chassis system-level locomotion performance evaluation [4].

METHODOLOGY

Before evaluating a rover chassis, the locomotion metrics needs to be defined. The rover objective for planetary exploration is to bring the scientific instruments to a specific site in order to examine geology, mineralogy or exobiology on other planets [9]. The rover chassis locomotion performance can be defined by the expected straight line path distance the rover can follow over a given terrain before a heading change is required. This is the definition of the mean free path (MFP) and can be used as a key metric for the locomotion evaluation activity.

The MFP is a probabilistic metric that depends on both the probability of encountering an obstacle and the rover chassis capability to overcome this obstacle. The MFP metric can be generated using exponential laws for defining the rock size and frequency distributions of the landing sites. Then the following rover locomotion performance as defined in [1] needs to be established:

- Trafficability : static stability, slope gradeability
- Terrainability : obstacle climbing ability, ground clearance

The RCET philosophy is to provide dedicated tools for computing the different locomotion parameters. The motion of a wheeled rover is achieved when a sufficient force can be applied at the wheel ground interface. The RCET computation tools consider the following parameters:

1. Wheel design parameters: diameter, width, grousers design, deformation (for flexible wheel only)
2. Soil properties: Bekker soil parameters are used or the friction coefficient for a rock-like obstacle
3. Wheel load: the normal force is computed based on the CoM location and the rover passive suspension
4. Wheel slip or torque: these values depend on the motion control strategy

For supporting the design of an ExoMars rover, the RCET methodology is to develop the wheel and the passive suspension quasi independently trough an optimization process. First, the best suitable wheel design parameters can be defined for a certain wheel load and soil with the tractive prediction module (TPM). During this preliminary optimization phase, the best suitable rover chassis concept and the optimal internal parameters can in parallel be achieved with the 2D quasi-static simulator. Because the wheel load repartition is a function of the rover passive suspension, the second step is either to post-process the simulation data with the TPM or to use the 3D simulation tool. Once the key dimensions are defined, the CAD model can be designed and used for having a complete 3D simulation of the rover chassis on a representative environment.

It has to be noticed that for a wheeled rover that feature a passive suspension, the only parameter that can be actively modified during the mission is the wheel torque. Finding the best suitable set of torques that minimized slippage and increased motion performance is out of scope of the current study. However, a first step was achieved during this activity and the preliminary results are presented.

MEAN FREE PATH

Golombek [12] derived quantitative rock distributions which accurately describe rock populations at the Martian surface and that have been validated with ground truth obtained at the Viking, Pathfinder and MER landing sites. Accordingly, cumulative fractional area F_k covered by rocks of diameter D or larger is given by

$$F_k(D) = k \exp[-q(k)D] \quad (1)$$

k is the total rock abundance and $q(k)$ governs drop. Similarly, the cumulative number of rocks per m^2 of surface for rocks of diameter D or larger can be described by

$$N(D) = L \exp[-sD] \quad (2)$$

where L is the number of rocks of all sizes per m^2 at the site.

The equation for the length x of the MFP as a function of the diameter of the minimum-sized non-traversable rock D_{i0} and of width of the mobile device b is [13]:

$$x = \frac{1 - \frac{b}{2} \sum_{i=10}^{\infty} D_i N_i - \frac{1}{2} \sum_{i=10}^{\infty} D_i^2 N_i}{b \sum_{i=10}^{\infty} N_i + \sum_{i=10}^{\infty} D_i N_i} \quad (3)$$

with N_i as the number of rocks per m^2 binned in a diameter range between D and $D+\delta D$. Rock cumulative number functions as per Eq. (3) can be converted into functions N_i as needed for the MFP. Based on these equations, it is possible to compute the MFP in function of the minimum sized obstacle rock.

This metrics is based on the rover vehicle width and the minimum-sized non-negotiable rock. The non-traversable slope and slope distribution are neglected by the proposed MFP approach. Based on these considerations, the RCET propose not using directly the MFP metric but focus on the maximal size of the rock the rover chassis is able to overcome and the slope gradeability.

SLOPE GRADEABILITY

If drawbar pull (DP) delivered were expended for soil slope climbing as per Eq. (4) below (Mg being vehicle weight), then limit soil slope angle δ can be obtained, assuming the vehicle operates at translational speeds in the validated range of a tractive prediction model (TPM) [2].

$$DP_{vehicle} = Mg \sin(\delta) \quad (4)$$

The assumption of having an equal wheel load repartition between each wheel independently of the slope angle, allow splitting the wheel comparison and wheel optimization process from the rover chassis concept evaluation. Therefore the first study is based on computing the drawbar pull versus slip on different soils with a constant wheel load. This load is considered to be the rover weight divided by the number of wheels.

This task is achieved by the TPM used in a standalone mode interfacing with the RCET I/F that allows extracting inputs data from the RCET database and visualizing the results. For assuring consistency of the data and validating the simulation, the evaluation process was done based on the average values of the soil properties of the material in the RCET Single Wheel Testbed (SWT) soil bin given in Tab. 1.

Tab.1: Bekker parameters of soil in SWT soil bin

Soil	Bulk density [kg/m ³]	Soil Cohesion [Pa]	Friction angle [°]	K _c [N/m ⁿ⁺¹]	K _φ [N/m ⁿ⁺²]	Deformation coeff. n [-]
DLR soil simulant C	1140	41	25.6	1342	265114	0.86

The drawbar pull in function of the wheel slippage is computed in a couple of seconds for a given configuration (i.e. the multi-pass effect is taken into account). The results are presented in Tab. 2 for rigid wheels of different widths and diameters:

Tab. 2: Parametric analysis for the rigid wheels on DLR soil C under Martian gravity

Wheel specification					
Diameter [m]	0.25	0.30	0.35	0.25	0.25
Width [m]	0.16	0.16	0.16	0.20	0.25
Number of grousers	31	31	31	31	31
Grouser height [mm]	6	6	6	6	6
Load [N]	112	112	112	112	112
Simulation results					
Max. Draw bar pull [N] (at this slippage value)	152.2 (10%)	155.6 (20%)	161.0 (40%)	163.4 (20%)	175.5 (30%)
Slope gradeability [°]	26.9	27.6	28.6	29.1	31.5
Sinkage [mm]	28.1 to 40.1	26.1 to 38.1	24.7 to 36.6	24.1 to 35.9	20.5 to 32.3
Torque [Nm]	10.1 to 16.2	11.5 to 18.9	12.9 to 21.7	10.1 to 17.3	10.1 to 18.7

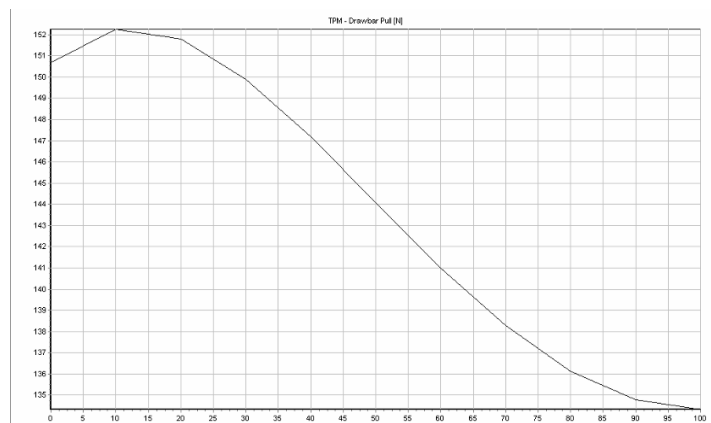

Fig. 1: Predicted drawbar pull vs slip curve for the MER wheel (1st column in Table 2) on DLR soil C under Martian gravity

This example demonstrates the capability of the tools for conducting a sensitivity study relative to different wheel parameters like the wheel diameter and width. If the predicted slope gradeability is a required information and input for computing the MFP, the maximum drawbar pull at a particular slippage value can also be used for the evaluation study. This allows having an estimation of the motion capability on a certain soil as a function of the wheel slip and, if required, to derive the slope gradeability. It is obvious from Fig.1 that the maximum drawbar pull is achieved for the MER rover on DLR soil C for a 10% slip value. However, on a slope we can expect having a non equal wheel load repartition as well as a different vehicle translational speed compared to what is valid for motion on a level surface, and therefore the best traction for each wheel is achieved at a different slippage value.

Standard motor drivers are not able to control the slippage that is a result of the applied wheel torque, the interaction with the ground and the overall rover speed. Critical situations can appear for large slip values since these lead to increased slip-sinkage and reduced drawbar pull (cf. Fig. 1). Thus, it could be advantageous to develop a motion controller that use an embedded TPM for defining the wheel torque in function of the DP vs slip curve.

STATIC STABILITY

Often, a geometrical calculation method based on the location of the CoM and the footprint is used for computing the static stability. In reality, a mobile rover has the capacity to adapt to the terrain profile. This is achieved on the MER and RCL-E (see Fig. 3) rover chassis with a passive suspension mechanism. These architectures have multiple degrees of freedom, which influence the static stability.

The static stability (uphill and downhill) is automatically computed by the RCET 2D simulator (2DS) based on the rover chassis kinematic equations. The 2DS loads the rover model generated with a graphical user interface that creates the mechanical model based on static equations. The simulation engine solves the balance of forces and torques and defines that the rover is stable as long as all normal forces on the wheel – ground contact points are greater than zero. This means that internal forces are included in the model and that effects caused by them are not ignored.

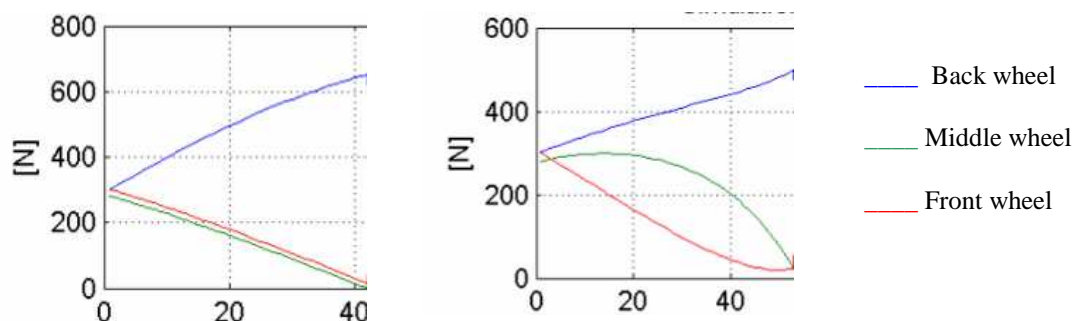

Fig. 2: Normal force evolution on slopes in [°] under Earth gravity, left-RCL-E* and right MER

* For passive suspension comparison purpose the RCL-E concept was scaled to fit the MER envelope.

Tab. 3: Static stability as computed with the RCET 2DS

	Static stability (geometric)		Static stability (simulation)	
	Uphill [°]	Downhill [°]	Uphill [°]	Downhill [°]
MER	55.68	-53.11	53.00	-45.00
RCL-E *	54.41	-54.41	54.00	-36.00
RCL-E	42.30	-42.30	42.00	-25.00

The static stability is a parameter used in order to establish the compliance to a requirement but is not directly a locomotion metric. The RCL-E vehicle with a CoM located as described in Fig. 3 will have an unacceptable loss of stability on a 25° slope when moving downhill. Therefore an iteration process is required in order to modify the CoM location or if this cannot be achieved, the key rover chassis dimensions needs to be modified.

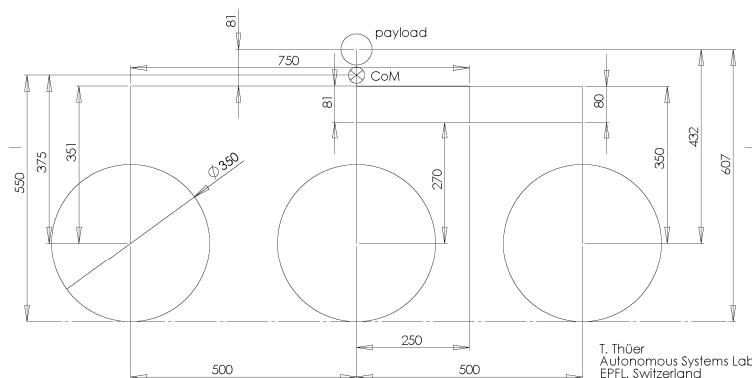

Fig. 3: RCL-E dimension considered for the evaluation study

In Fig.2 we can see the evolution of the wheel load in function of the slope angle. The influence of the passive structure to the wheel load repartition is clearly visible. In order to take into account this phenomenon the data computed by the 2D simulator was post-processed with the TPM.

Tab. 4: Slope gradeability based on the wheel load repartition for the MER and the RCL-E*, DLR soil C, under Martian gravity

Nb of wheel	Load _{MER} [N]	Load _{RCL*} [N]	DP _{MER} [N]	DP _{RCL*} [N]	Slope _{MER} [°]	Slope _{RCL*} [°]	Slope _{Ea6} [°]
Front	41	46	38.7	40.1	-	-	-
Middle	104	39	54.5	37.5	-	-	-
Back	154	214	61.8	65.9	-	-	-
Total (2x3w)	598	598	310	287	27.5	25.2	25.0

It has to be noticed that due to a non equal load repartition, the DP was computed at 100% slip for each wheel and without taken into account the multi-pass effect. This effect can be in favour of the MER due to higher load on the middle wheel. The slope gradeability based on the wheel load computed by the 2D simulator is close to the previous value for the MER but is reduced by 7% for the RCL-E. This is mainly due to the important load that appears on the back wheel during the slope climbing as highlighted in Fig. 2.

In standard situation, an accurate slope gradeability value that includes the multi-pass effect can be computed with the TPM and using Eq. (5) that takes into account the reduction of the normal force acting on the wheel as a function of slope angle:

$$N_{wheel} = \frac{Mg \cos \delta}{n} \quad (5)$$

The second iteration of the DP computation based on the TPM but with a new wheel load of 100N instead of 112N gives 25°. It has to be noticed that actual MER slope gradeability on this soil is not available from test data and therefore this particular analysis procedure still needs to be validated against H/W measurements.

OBSTACLE CLIMBING ABILITY

The evaluation of the MER and the RCL-E rover chassis was performed using the 2D quasi static simulator and the 3D simulator. Because both rovers have different mass, footprint and wheel design, we expect from the beginning that a fair trade-off will not be possible. Therefore, normalisation rules were developed and used. The RCL-E* was modified to fit the MER envelope and total mass. Both the MER and RCL-E* passive suspensions feature the same wheel.

The key metric for the trafficability analysis is the draw bar pull vs slip. For the obstacle climbing ability over rocks, the friction coefficient metric is used [8]. This coefficient defined the maximum force a wheel can apply on a hard material as a function of the normal force. Because the normal force is known but a priori not the ground characteristics, the best rover chassis for motion in rough terrain is the one that required the lowest friction coefficient to overcome an obstacle. Fig. 4 reports the friction coefficient required for the three investigated rovers for overcoming a 26 cm high step.

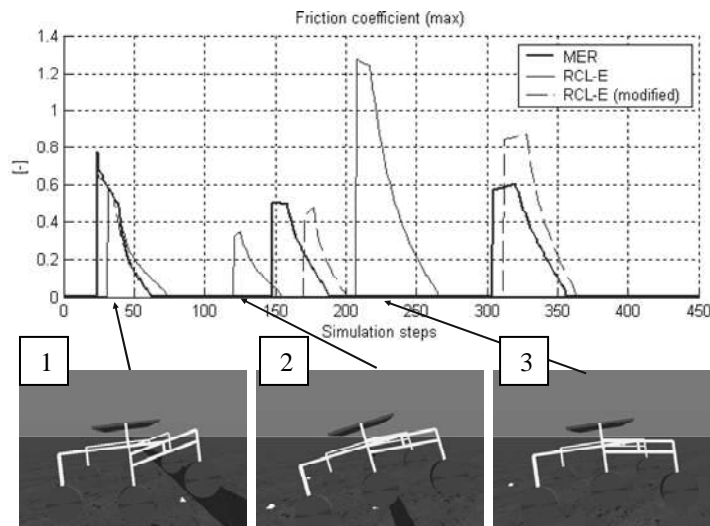

Fig.4: Required friction coefficient for the MER, RCL-E and RCL-E* rover on a 260 mm step up

Fig.4 shows that the original version of the RCL-E has the worst performance by far. The critical motion appears when the back wheel climbs the step. This stems from the fact that it is shorter than the other models. The reduced length leads to a higher pitch angle on the same obstacle which has increased weight on the back wheel as a consequence. Therefore for rover chassis comparison purposes, it is more relevant to compare normalised structures, in our current case, the MER and the RCL-E*.

Tab. 5: Predicted obstacle climbing capability based on the friction coefficient for the MER and RCL-E* rovers

Chassis	Wheel	Mass [kg]	26 cm high step obstacle		15 cm hemispherical obstacle	
			Required friction coefficient	Situation (see Fig. 4)	Required friction coefficient	Situation (see Fig. 4)
MER	MER	180	0.7	1	0.37	1, 2, 3
RCL-E	Ø0.35	240	1.3	3	0.33	3
RCL-E*	MER	180	0.9	3	0.47	1

The friction coefficient value for a rock is estimated to be between 0.3 and 0.5. Therefore no one of the tested rover chassis can overcome a 26cm obstacle with a 90° edge on Earth. A run over a 0.15m diameter semi-spherical obstacle was also performed. As a result of such exercise, via an iterative process and as a function of a defined friction coefficient, the minimum-sized non-negotiable rock can thus be defined and the MFP computed with Eq. (3). These examples demonstrate that it is possible to trade-off and optimised a rover chassis climbing abilities without requiring any knowledge of the soil parameters. Moreover, the fact that the rover is not stopped during the simulation run allows analysing the full chassis behaviour over an obstacle (i.e. unrealistic friction coefficient is allowed). For example the

RCL-E rover chassis has a weakness when the back wheel has to overcome an obstacle (Fig 4, position 3) and the MER is more penalised by its front wheel (Fig 4, position 1).

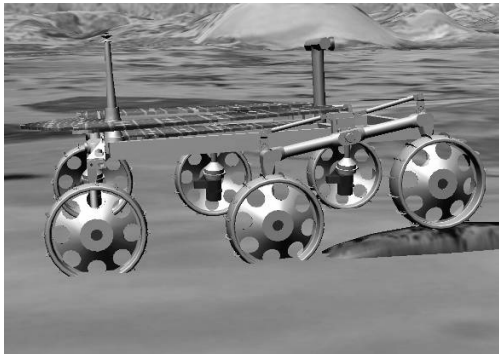

Fig.5: Animated SIMPACK 3D MBS model with integrated CAD data of the RCL-E rover.

In order to take directly into account the soil parameters and 3D effects, the use of MBS (Multibody System) simulation environment is required. The SIMPACK 3D simulation tools allows the investigation of rover configurations under Martian conditions, considering gravity and soil conditions on Mars and the integration of the wheel-soil interaction in the dynamical multibody simulation. The integration of the validated TPM was achieved and is coupled with the used rheological soil model for contact force description.

As an important step for integration into the conceptual design phase the possibility of implementing even large and detailed CAD models in the MBS environment is given. For visualisation it is possible to export the MBS animation in VRML format so that a 3D impression of a rover manoeuvring on Mars can be gained (see Fig.5). Investigations with rovers

fully equipped with science instruments can thus be performed and issues like packaging and dynamic relations can be taken into account. Furthermore the modular concept makes it possible to integrate in particular control elements into the simulation environment like the slip based traction control. The only current limitation is that step simulation for obstacles is not possible so far because obstacles must have a continuous shape in first and second order.

S/W VALIDATION

Test and measurement of wheels and rovers are complementary to the simulation, for calibrating the applications and for validation purposes. Two different testbeds, one dedicated to single-wheel characterisation and another one for rover system-level locomotion performance evaluation, were used as shown on Figs. 6 and 7. Both testbeds feature soil bins filled with appropriate Martian soil simulant. The main testbed purpose is to measure vehicle tractive ability (i.e. drawbar pull) on homogeneous surfaces and under controlled conditions.

This way, the RCET tractive prediction module (TPM) was subjected to validation of its single wheel and multiple pass wheel-soil predictive capabilities. As a result, several distinct modifications into previous terramechanical wheel-soil models were introduced [2], relating primarily to modelling of slip-sinkage behaviour.

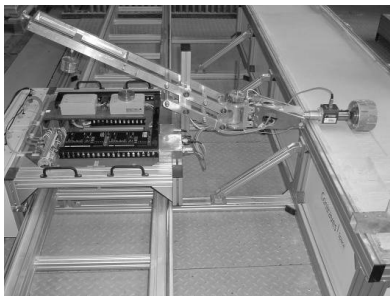

Fig.6: RCET Single-wheel testbed at DLR

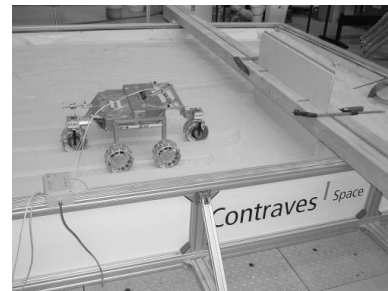

Fig.7: RCET system-level testbed at DLR

CONCLUSION

The RCET study confirmed that an optimal rover wheel design can be achieved based on the expected soil properties and a certain wheel load range. The key metric is the drawbar pull as a function of the wheel slippage. The evaluation process and optimisation is performed with the support of the RCET Tractive Prediction Module (TPM) that was validated against wheel measurements performed with the single wheel testbed. This tool allows also predicting the

slope gradeability and the maximal required torque. The limitation in a standalone mode is that modification of the load due to the passive suspension is not taken into account.

The suspension modifies the wheel load repartition as a function of the terrain profile. For having the possibility to trade-off structures at an early design stage and for allowing a parametric analysis, a 2D simulator and visual I/F were developed in RCET as well. Different rovers can be easily designed and the normal forces computed on different terrain. Two different controllers are implemented: computation of the minimal torque required for a constant speed motion or computation of a specific torque per wheel in order to minimise the required friction coefficient. Except for the diameter, the wheel design does not affect significantly the climbing performances and a parametric study can be done to find out the optimal internal chassis dimension. This process is conducted in parallel to the wheel optimisation process.

For completing the study based on a 2D quasi-static simulation, the simulation data can be sent to the TPM for taking into account the nature of the soil. This two step study, allows first to optimise and evaluate suspension mechanism without taking into account the soil parameters, then detailed information can be provided by data post-processing. The multi body 3D simulation engine that includes the validated TPM needs also to be used for having a realistic simulation of the rover chassis on a Martian environment. The slope gradeability, the drawbar pull versus slip, the maximum torque, the wheel sinkage and the power requirement can be computed.

Studying rover chassis on a particular terrain highlights the dependence between rover locomotion performances and the motion controller. The wheel slippage affects the drawbar pull and the wheel translational speed. The slippage value cannot be controlled with standard drivers that use either a constant torque or constant speed mode. A future work of this study can be the utilisation of the simulation tools (TPM and kinematic equation based algorithm) and the experience gained in this study in order to implement an optimal motion control [3, 5, 6].

The conclusion is that there is less difference in terms of performances between two different rover chassis than between the same architecture with different internal dimension. This highlights the importance of using simulation tools for supporting the design of a rover chassis and of wheels for a particular mission.

REFERENCES

- [1] D. Apostolopoulos, *Analytical Configuration of Wheeled Robotic Locomotion*, The Robotics Institute, Carnegie Mellon University, 2001.
- [2] L. Richter et al., *A Predictive Wheel-Soil Interaction Model for Planetary Rovers Validated in Testbeds and Against MER Mars Rover Performance Data*, proceeding of the 10th European Conference of the International Society for Terrain-Vehicle Systems (ISTVS), October 2006.
- [3] K. Yoshida et al., *Slip-Based Traction Control of a Planetary Rover*, Tohoku University and Mazda Motor Corporation, Sendai, Japan, ISER 2002.
- [4] S. Michaud, L. Richter and al., *RCET: Rover Chassis Evaluation Tools*, Proceeding of the ASTRA 2004, ESTEC, the Netherlands, 2004.
- [5] P. Lamon, R. Siegwart, *3D-Odometry for rough terrain – Towards real 3D navigation*, Paper for the ICRA Conference, 2003.
- [6] ESROL-A, *Preliminary Adaptation of Original Concept*, RCL Report Ref. Nr. PAOC-1011/2003/RCL, 2003.
- [7] P. Lamon, T. Thueer et al., *Modelling and Optimization of Wheeled Rovers*, Proceeding of the ASTRA 2004, ESTEC, the Netherlands, 2004.
- [8] A. Krebs, T. Thueer, S. Michaud and R. Siegwart, *Performance Optimization of All-Terrain Robots: A 2D Quasi-Static Tool*, Proceedings of the International Conference on Intelligent Robots and Systems, 2006.
- [9] S. Michaud, A. Schneider, R. Bertrand et al., *SOLERO: Solar-Powered Exploration Rover*, Proceeding of the Advanced Space Technologies for Robotics and Automation ASTRA 2002, ESTEC, the Netherlands, 19-21 November 2002.
- [10] M. Bekker, *Theory of Land Locomotion: Mechanics of Vehicle Mobility*, University of Michigan Press, Ann Arbor, USA, 1959.
- [11] J. Y. Wong, *Theory of Ground Vehicles*, Wiley-Interscience, 2001.
- [12] M.P Golombek, *Rock Statistics Calculations for the MER Landing Sites*, Landing Site Workshop, Pasadena, CA, March 27, 2002.
- [13] B. Wilcox, A. Nasif, R. Welch, *Implications of Martian Rock Distributions on Rover Scaling*, JPL, California Institute of Technology, 1977.