

# KISS PULPino - Updates on PULPino

## updates on PULPino

### Other Conference Item

**Author(s):**

Pullini, Antonio; Gautschi, Michael; [Gürkaynak, Frank Kagan](#) ; Glaser, Florian; [Mach, Stefan](#) ; Rovere, Giovanni; Schiavone, Davide; Haugou, Germain; [Palossi, Daniele](#) ; Marongiu, Andrea; Flamand, Eric; [Benini, Luca](#) ; et al.

**Publication date:**

2016

**Permanent link:**

<https://doi.org/10.3929/ethz-a-010810277>

**Rights / license:**

[In Copyright - Non-Commercial Use Permitted](#)

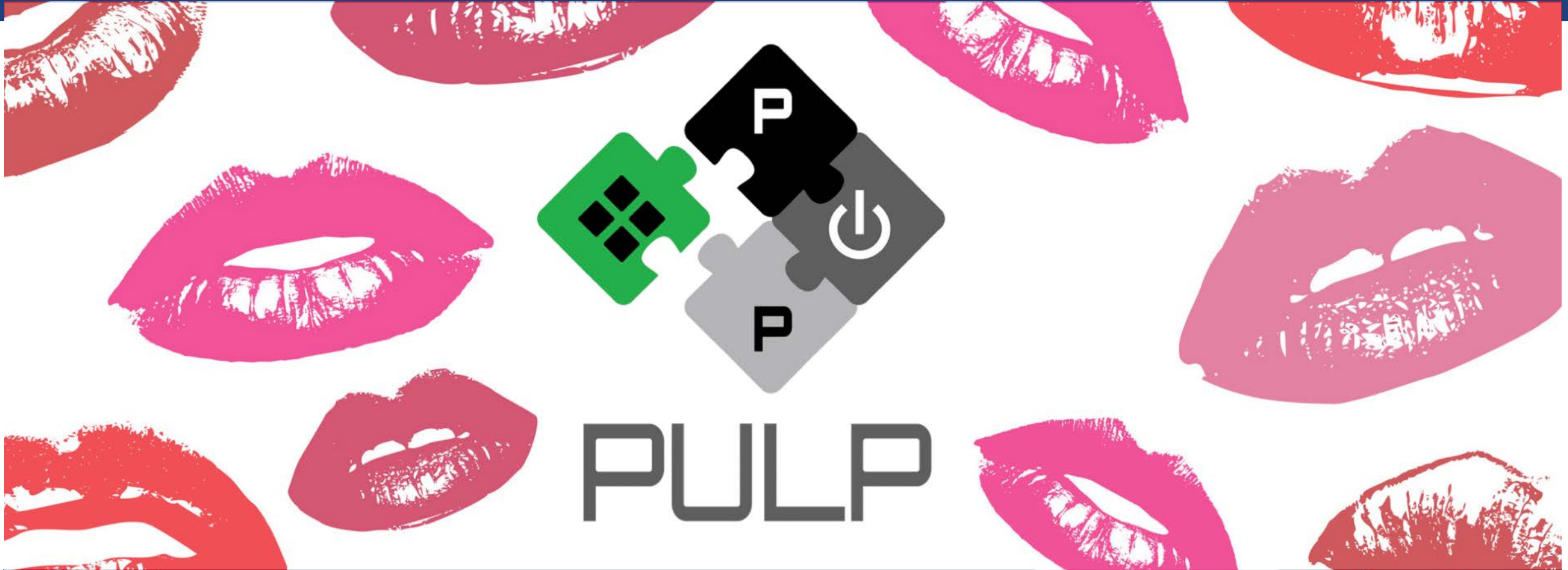

# KISS PULPino

## Updates on PULPino

5<sup>th</sup> RISC-V Workshop, Mountain View (California), Florian Zaruba

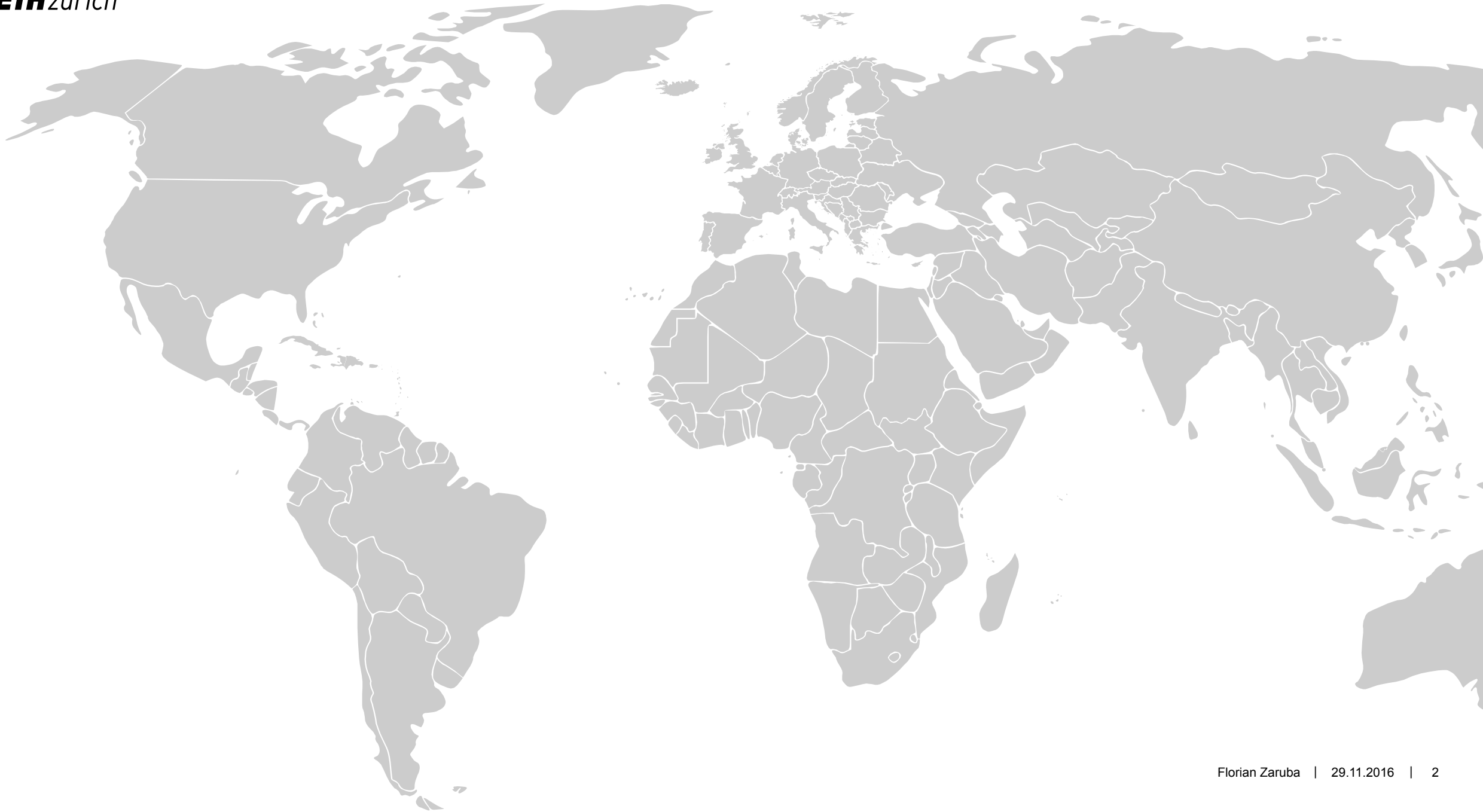















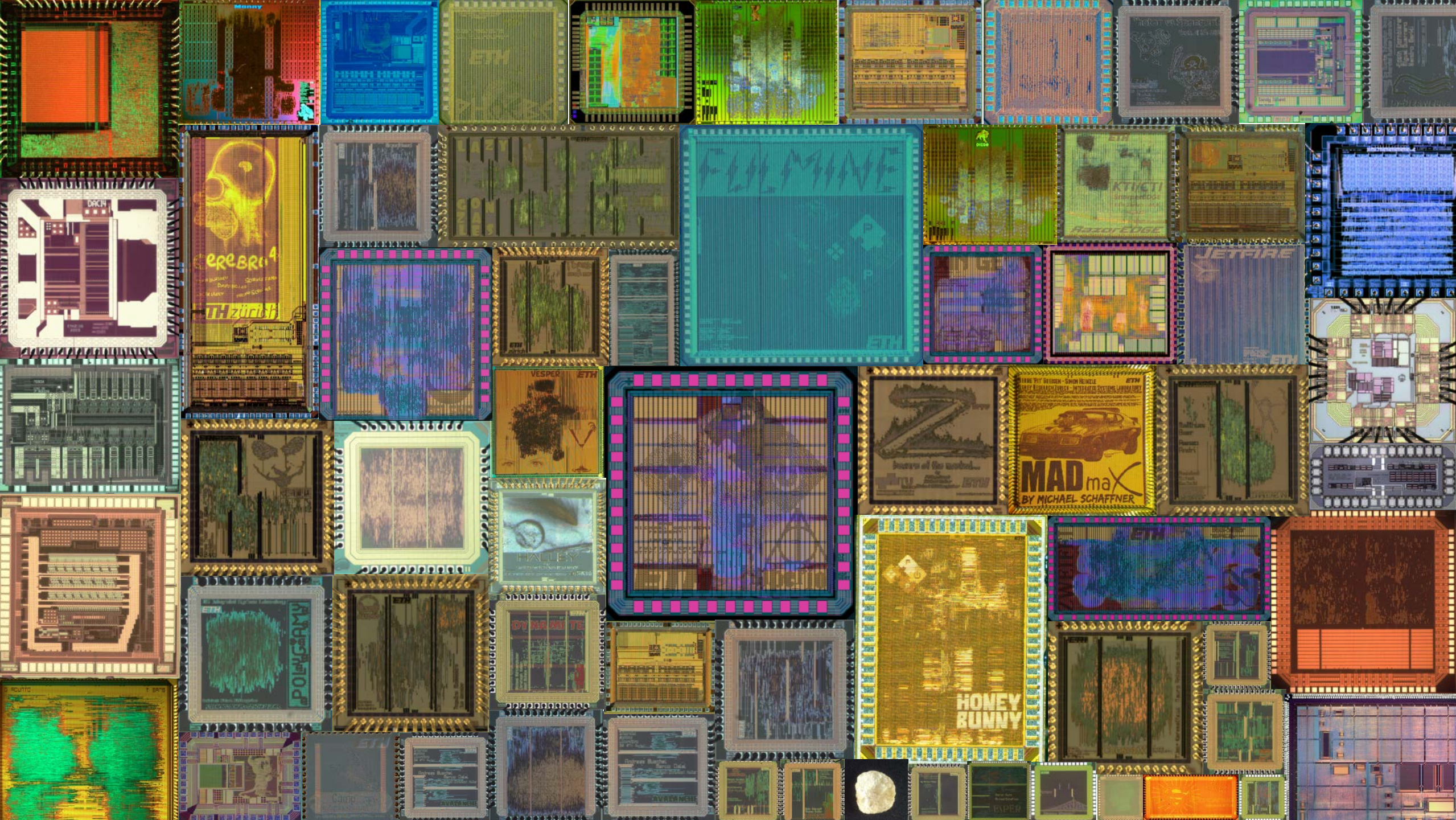

# Imperio

- **First** ASIC of PULPino (UMC 65)
- Complete  $\mu$ C (RV32IMC)
- Integrated FLL
- **Speed:** 500 MHz
- **Peripherals:**
  - 19 GPIOs, UART, I2C, SPI
  - JTAG Debug Interface
- 64 kB RAM
- **Operating Voltage:**
  - 0.9 – 1.2 V
- **Dynamic Power:**
  - 14 – 71  $\mu$ W/MHz, 1.2 V
  - 3 – 15  $\mu$ W/MHz, 0.9 V
- **Leakage:** 150  $\mu$ W
- **Area:**
  - 700 kGE\* (SoC)
  - 40 kGE\* (Core)

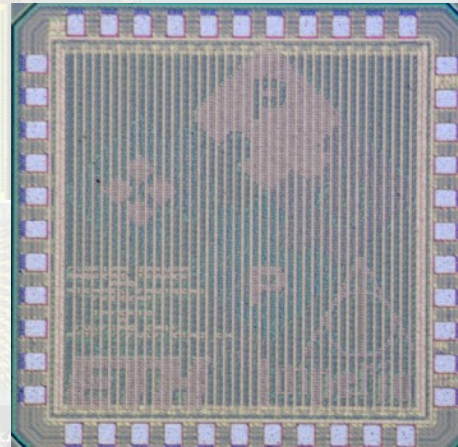

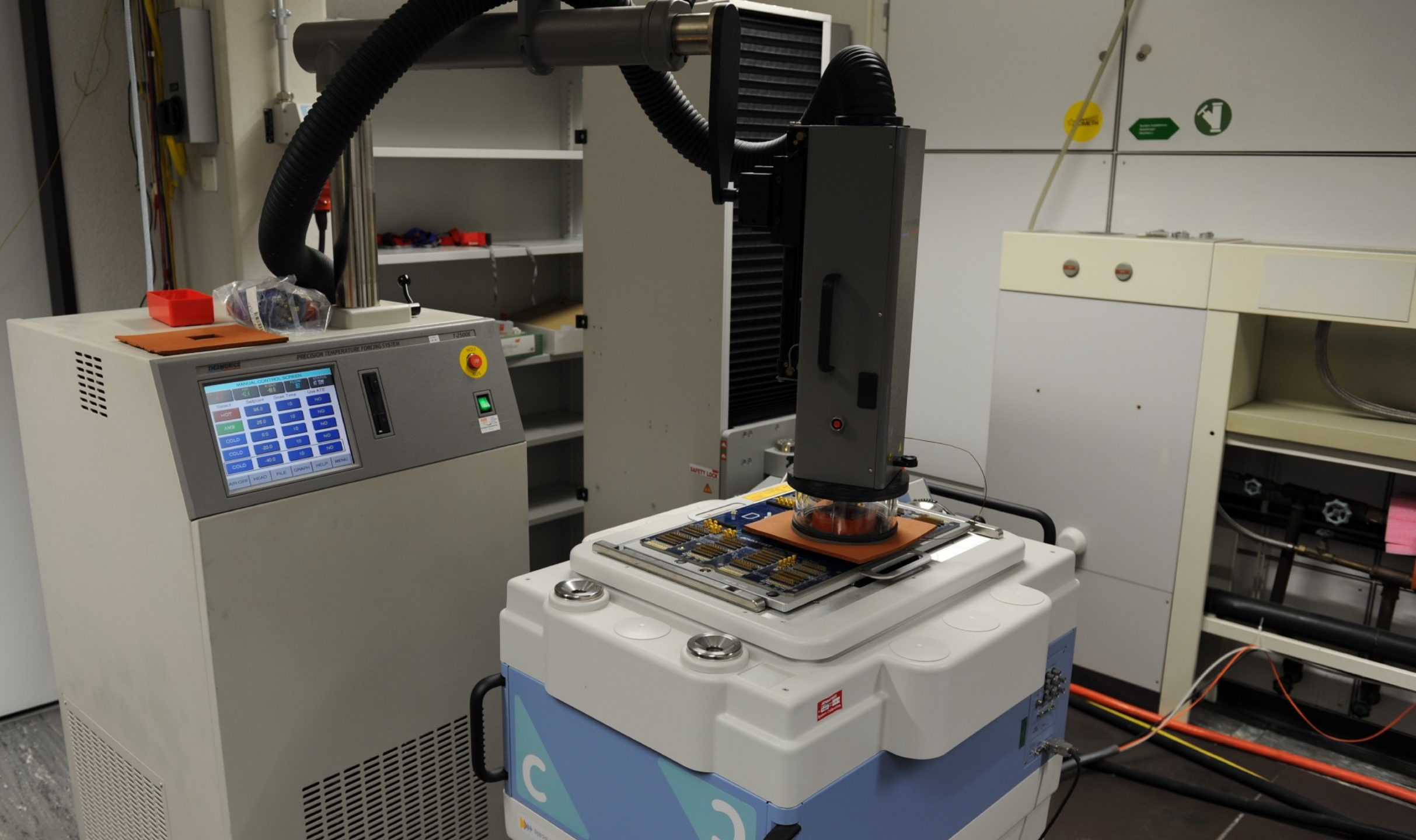

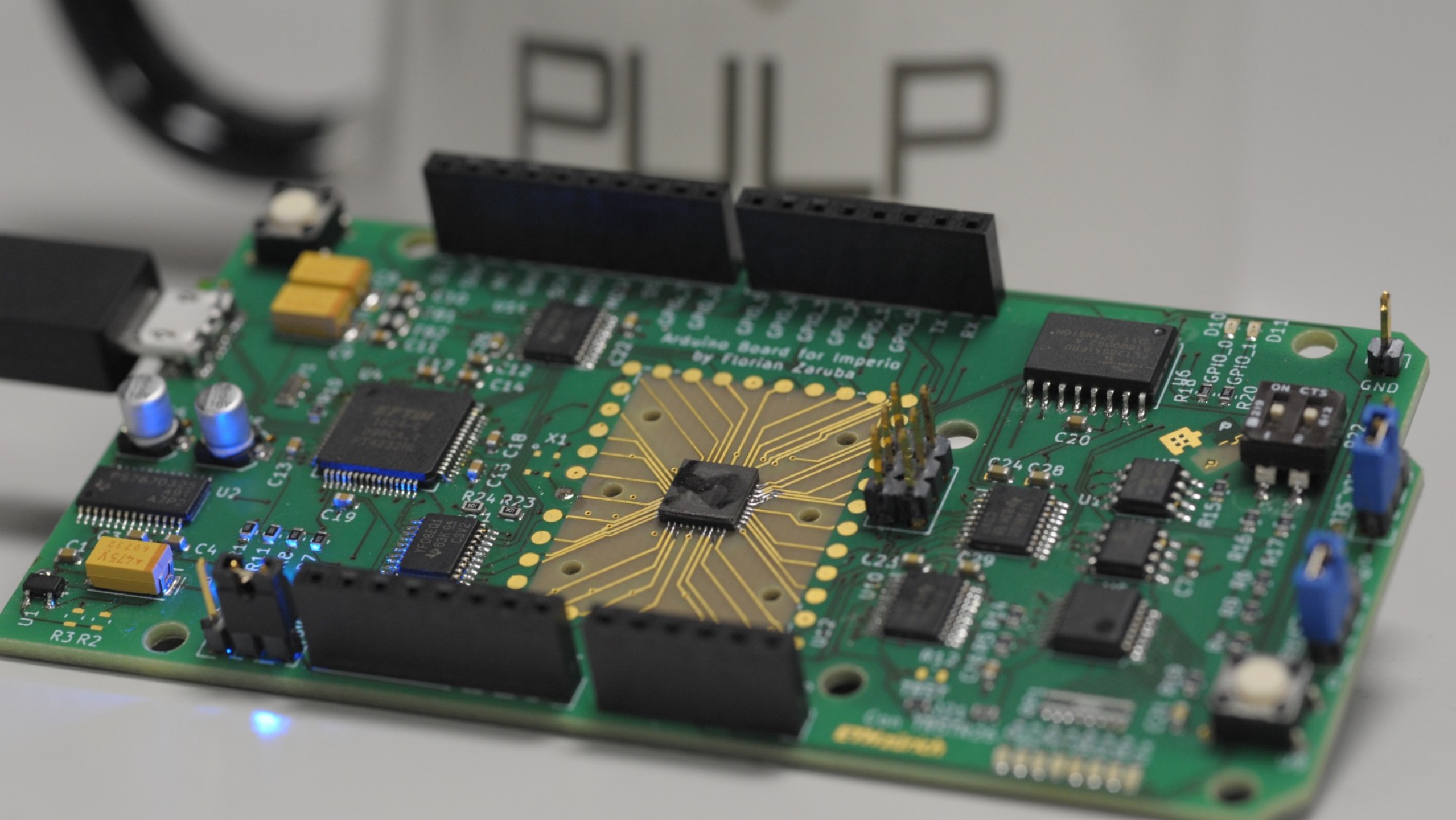

# Parallel Ultra Low Power Platform

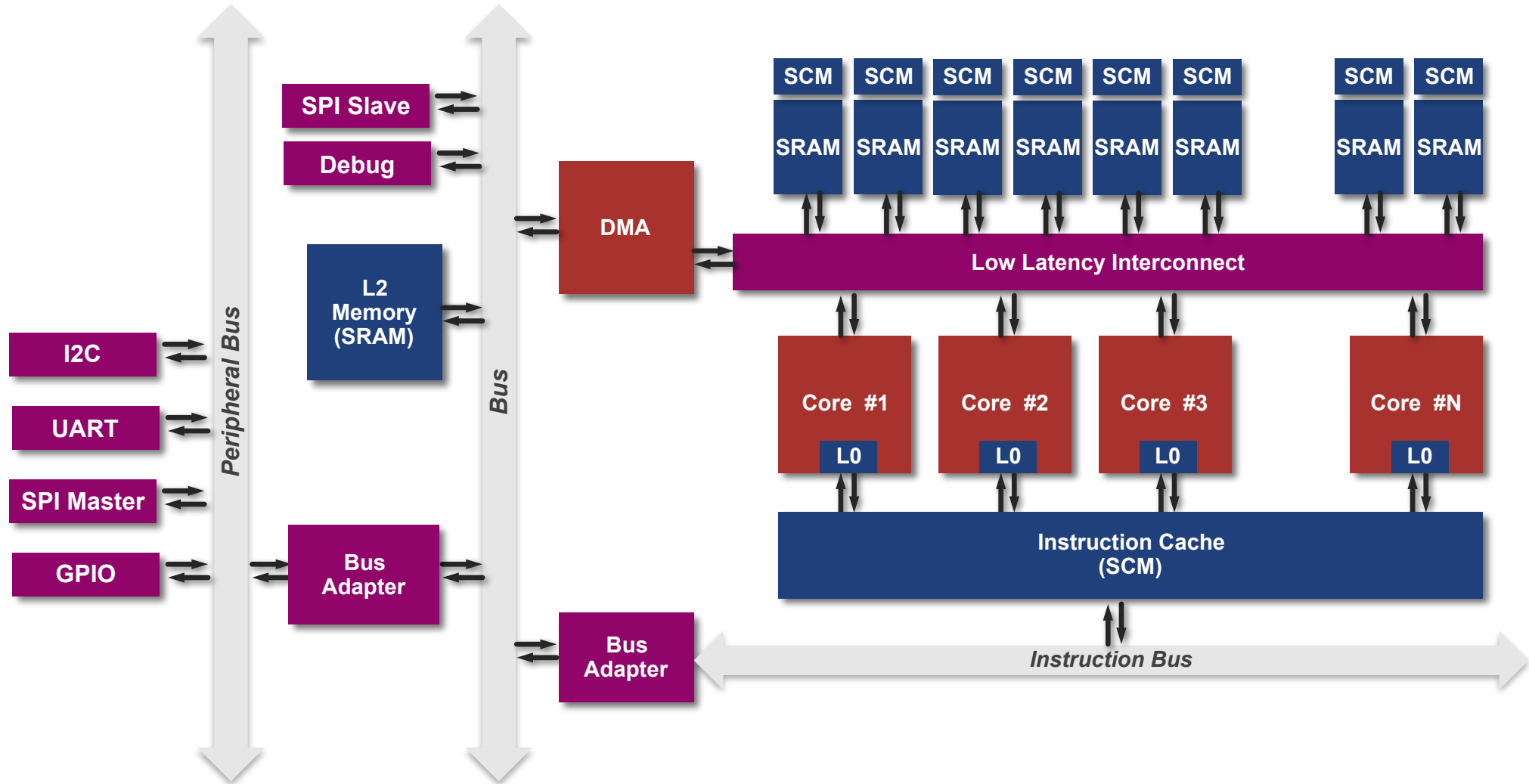

# Parallel Ultra Low Power Platform

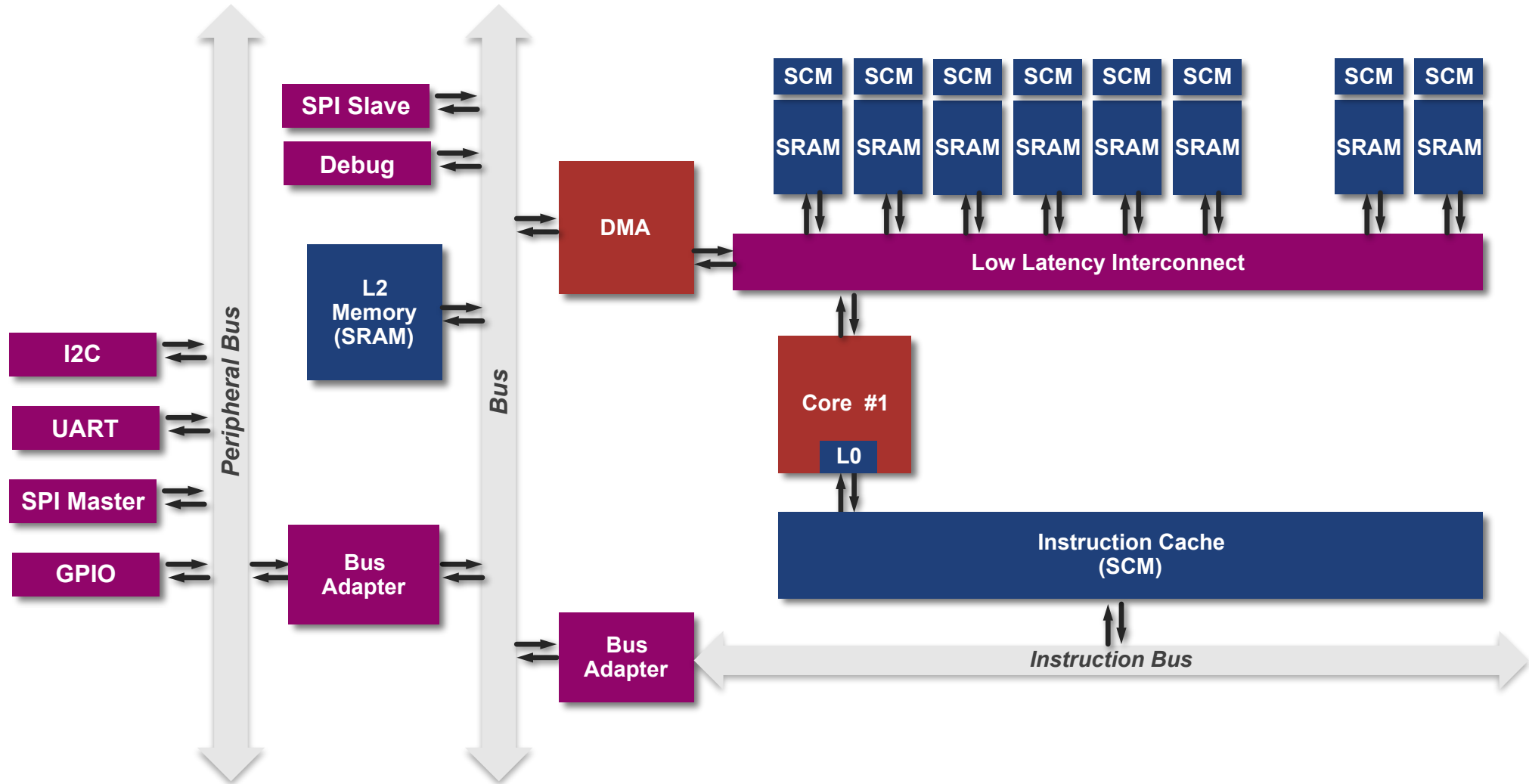

# Parallel Ultra Low Power Platform

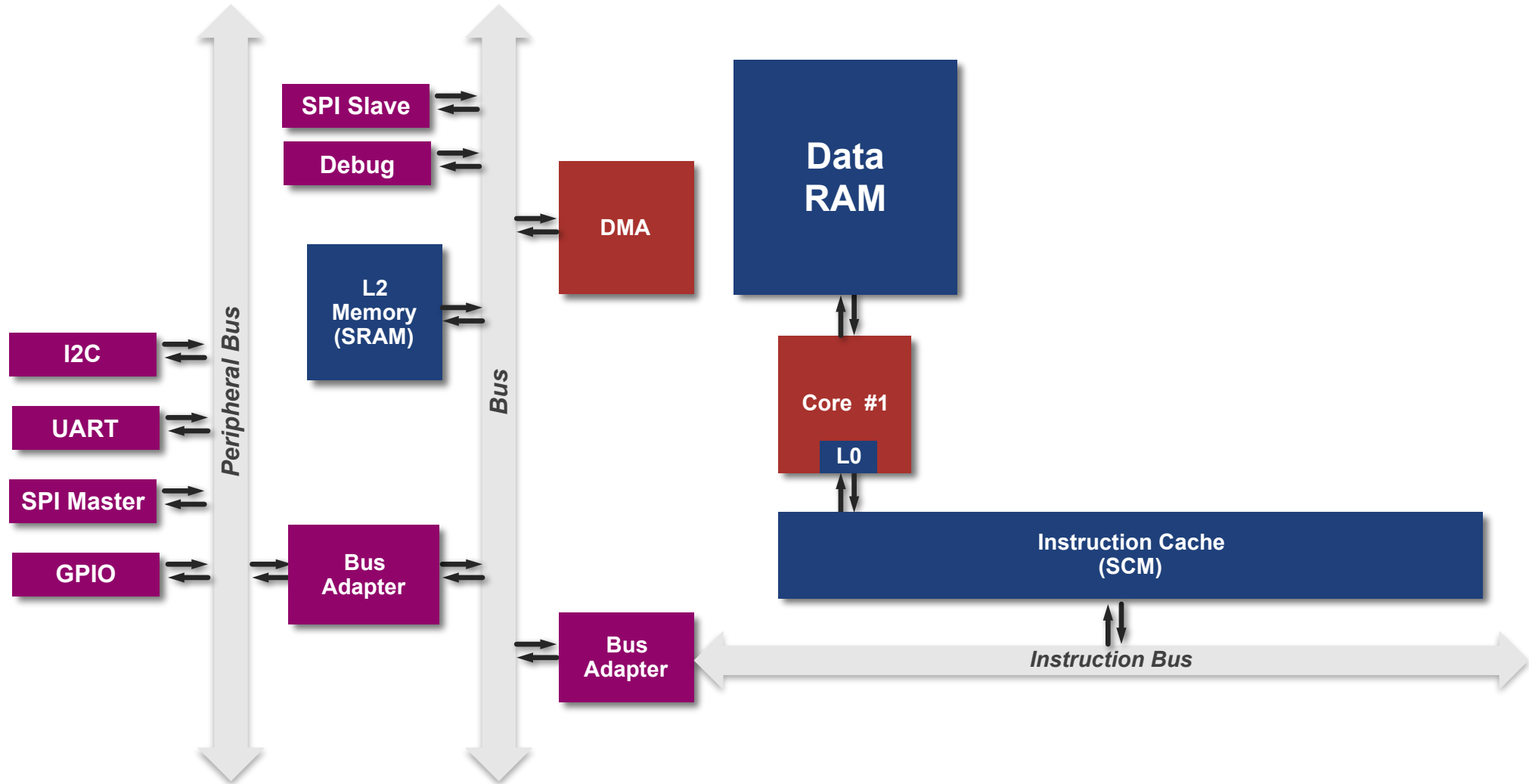



# Parallel Ultra Low Power Platform

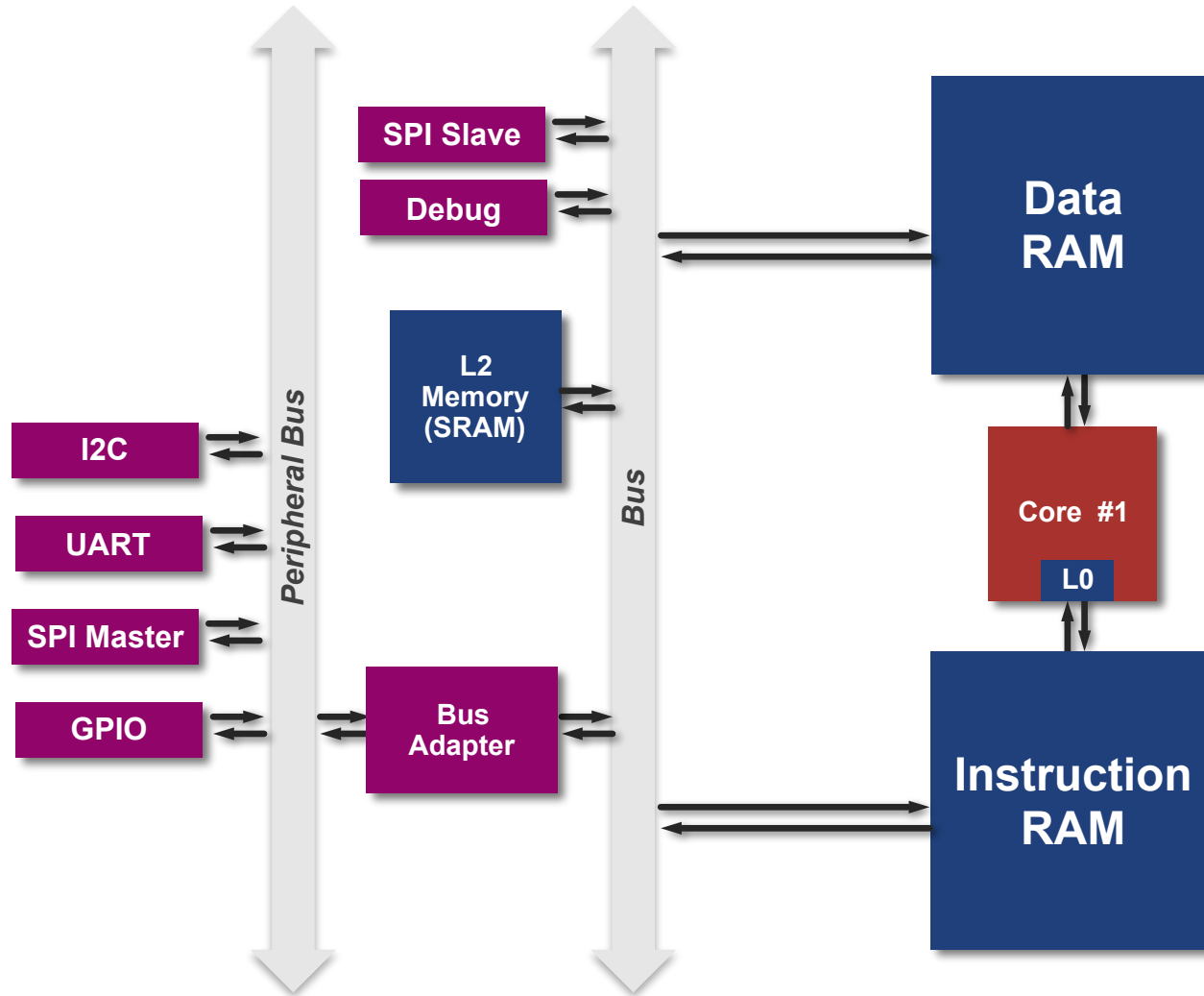

# PULPino

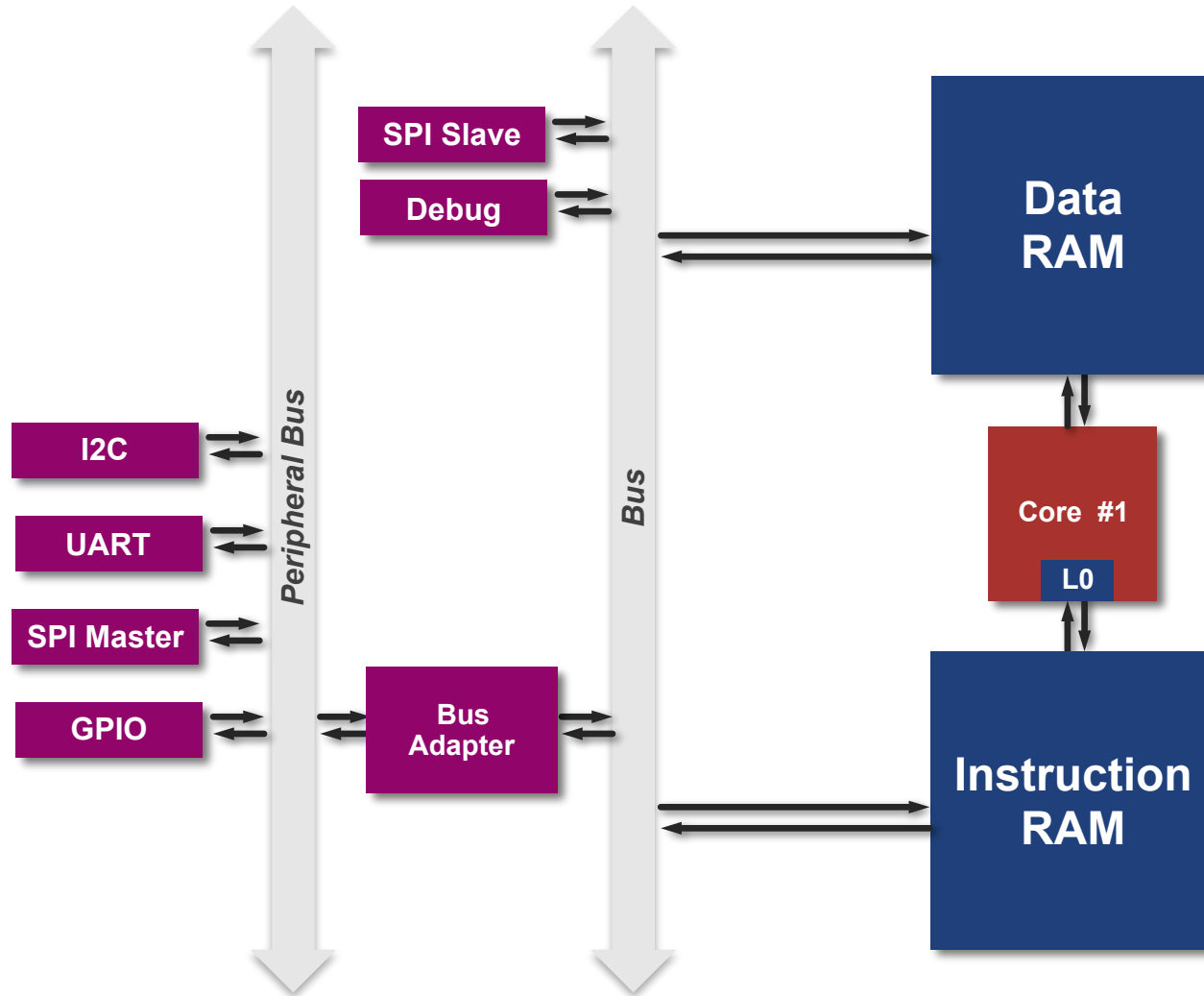

# Current State

- RV32ICM + custom instructions
  - Hardware-loops
  - Post-incrementing load and stores
  - SIMD
- Patch for RISC-V toolchain
  - Built-ins for SIMD
  - Infers instructions
- 10x efficiency increase
- Support for **all** targets:
  - RTL simulation
  - FPGA mapping
  - Virtual platform
  - ASIC
- Silicon proven core
- 3.19 Coremark/MHz
- 1.2 DMIPS/MHz





# PULP



# PULP

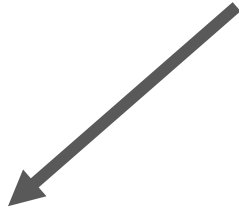

## Multicore Cluster

- PULP
- Research

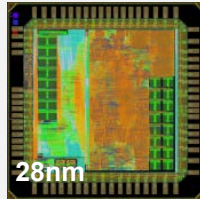
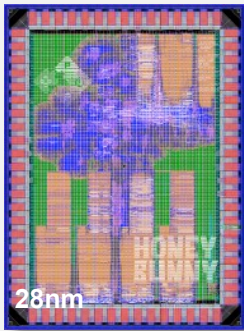



# PULP

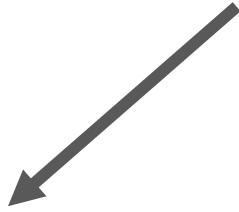

## Multicore Cluster

- PULP
- Research

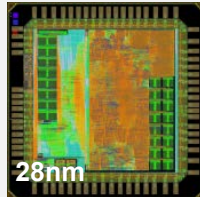
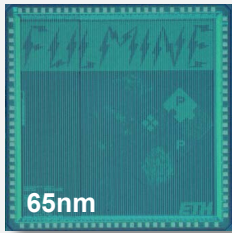
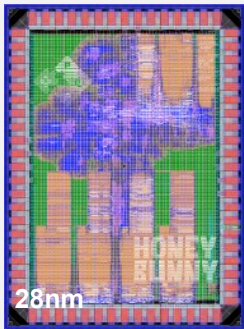

## Standalone µC

- PULPino
- Ease of use

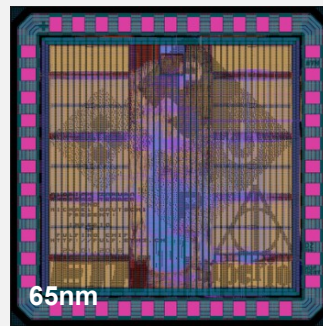



# PULP

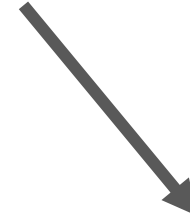
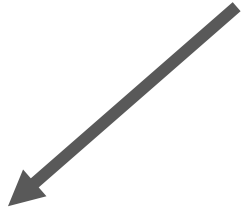

## Multicore Cluster

- PULP
- Research

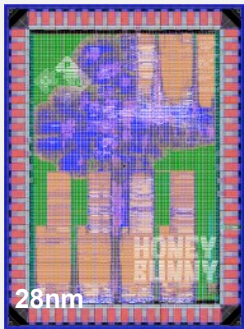

28nm

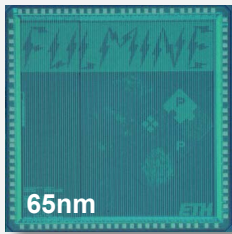

65nm

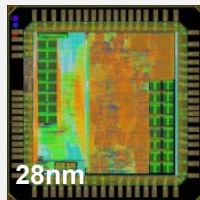

28nm

## Standalone µC

- PULPino
- Ease of use

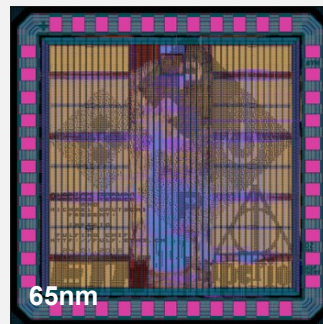

65nm

## Mixed signal

- VivoSoC
- Healthcare

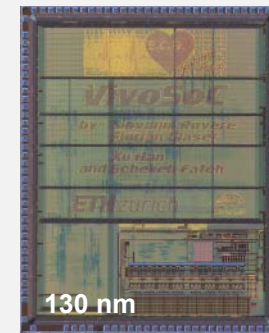

130 nm

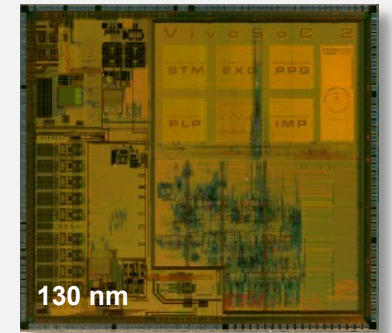

130 nm

# Open Sourcing PULPino

- We open sourced PULPino on 1<sup>st</sup> March 2016...
- ... and got fantastic media coverage
- Over 15,000 users visited our website
- More than 600 unique clones on GitHub
- Over 20 companies and research institutes use PULPino



# Open Sourcing PULPino

- We open sourced PULPino on 1<sup>st</sup> March 2016...
- ... and got fantastic media coverage
- Over 15,000 users visited our website
- More than 600 unique clones on GitHub
- Over 20 companies and research institutes use PULPino

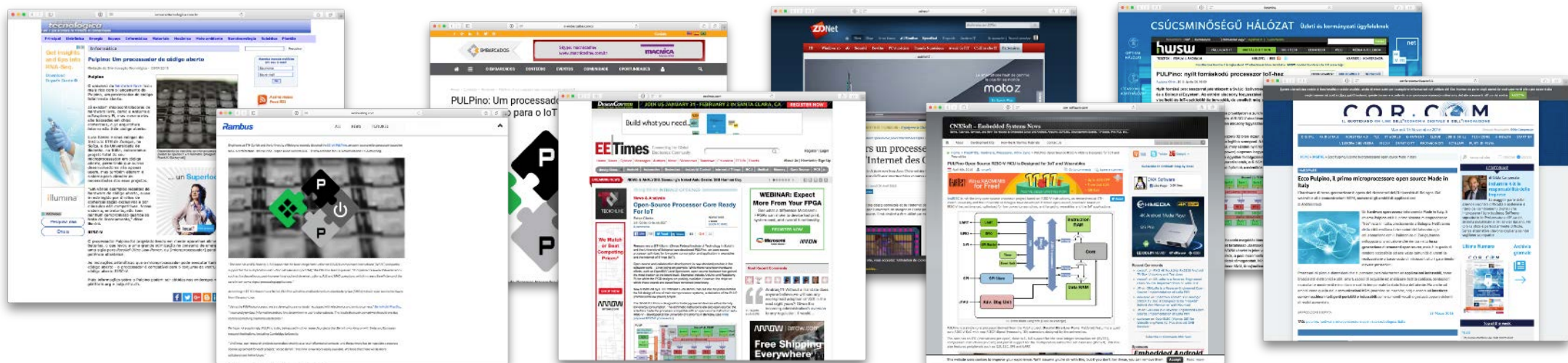

# Future of PULPino (PULPino V2)

- Continue this success
- **PULPino V2:**
  - Support for Verilator simulation
  - IP-XACT description
  - New peripherals ( $\mu$ DMA)
  - New, streamlined event unit
  - SDK
  - Updated compiler
  - Improved documentation and tutorials

- 1 March 2016**  
First release of PULPino
- 2 May 2016**  
Toolchain for our modified RISC-V implementation
- 3 May 2016**  
DSP oriented extensions
- 4 Q1 2017**  
PULPino V2
- 5 Late 2017**  
PULPino V3, Virtual platform (ISS)

# Future Efforts

# Future Efforts

## Privileged ISA

- Secure PULPino, MMU
- Sel4 OS



# Future Efforts

## Privileged ISA

- Secure PULPino, MMU
- Sel4 OS



## < 10 kGE RISC-V

- RV32 IC
- 1 & 3 stage pipeline



# Future Efforts

## Privileged ISA

- Secure PULPino, MMU
- Sel4 OS



## < 10 kGE RISC-V

- RV32 IC
- 1 & 3 stage pipeline



## Heterogeneous configuration

- FPU
- Accelerators



# Get in touch with us!

Subscribe to our mailing list by sending:  
subscribe pulp-info Firstname Lastname  
to [sympa@list.ee.ethz.ch](mailto:sympa@list.ee.ethz.ch)

## Check us out on:



<https://github.com/pulp-platform>



[https://twitter.com/pulp\\_platform](https://twitter.com/pulp_platform)



<http://www.pulp-platform.org>



# Questions?

[www.pulp-platform.org](http://www.pulp-platform.org)

Florian Zaruba  
zarubaf@ethz.ch

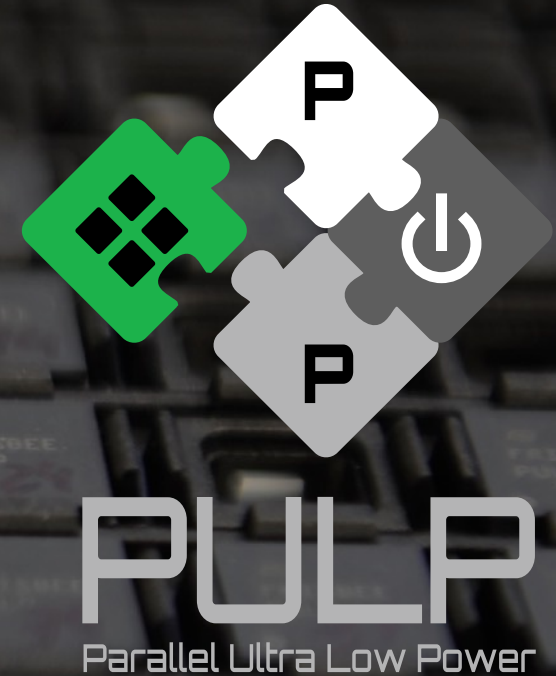

Davide Rossi<sup>1</sup>, Igor Loi<sup>1</sup>, Antonio Pullini<sup>2</sup>, Francesco Conti<sup>1</sup>, Michael Gautschi<sup>2</sup>, Frank K. Gürkaynak<sup>2</sup>, Florian Glaser<sup>2</sup>, Stefan Mach<sup>2</sup>, Giovanni Rovere<sup>2</sup>, Davide Schiavone<sup>2</sup>, Germain Haugou<sup>2</sup>, Manuele Rusci<sup>1</sup>, Alessandro Capotondi<sup>1</sup>, Giuseppe Tagliavini<sup>1</sup>, Daniele Palossi<sup>2</sup>, Andrea Marongiu<sup>1,2</sup>, Fabio Montagna<sup>1</sup>, Simone Benatti<sup>1</sup>, Eric Flamand<sup>2</sup>, Luca Benini<sup>1,2</sup>



<sup>1</sup>Department of Electrical, Electronic  
and Information Engineering

**ETH** zürich  
<sup>2</sup>Integrated Systems Laboratory