

Reflection seismic 1 script

Educational Material

Author(s):

Kruk, Jan van der

Publication date:

2001

Permanent link:

<https://doi.org/10.3929/ethz-a-004363847>

Rights / license:

[In Copyright - Non-Commercial Use Permitted](#)

Literature

Seismics:

Hatton, L., Worthington, M.H. and Makin, J. (1986). Seismic data processing - Theory and practice. Blackwell Scientific publications, Oxford, UK, 177 pp.

Sheriff, E.G. and Geldart, L.P. (1995). Exploration Seismology, (2nd ed.). Cambridge University Press, Cambridge, 592 pp.

Yilmaz, Ö. (1987). Seismic data processing. SEG Tulsa, OK, 826 pp.

Interpretation of seismic data:

Emery, D. and Myers (eds.) (1996). Sequence Stratigraphy. Blackwell Science, Oxford, UK, 297 pp.

McQuilin, R. et al. (1986). An introduction to seismic interpretation. Graham and Trotman Ltd., London, UK.

Applied Geophysics in general (with one part about Seismics):

Dobrin, M.B. and Savit, C.H. (1988). Introduction to geophysical prospecting (4.ed). McGraw-Hill Book Company, New York, 867 pp.

Kearey, P. and Brooks, M. (1991). An introduction to geophysical prospecting. Blackwell Scientific Publications, Oxford, 254 pp.

Reynolds, J.M. (1998). An introduction to applied and environmental geophysics. John Wiley and sons, Chichester, UK, 796 pp.

Telford, W.M., Geldart, L.P. and Sheriff, R.E (1990). Applied Geophysics (2. ed.). Cambridge University Press, Cambridge, 770 pp.

Preface

This script doesn't replace a text book.

Warning: It is possible that this script contains some errors. I appreciate all suggestions to improve this script

This script is translated from German and was initially written by Frank Nitsche and supplemented by Jan van der Kruk

Adresse:

Jan van der Kruk
Institut für Geophysik
ETH Zürich
ETH Hönggerberg (Gebäude HPP, Raum O6)
8093 Zürich
Tel.: (01) 633 2657
E-Mail: jvdkruk@aug.ig.erdw.ethz.ch
www: <http://www.aug.geophys.ethz.ch/teaching/>

1. Introduction

The aim of this lecture is to discuss the basic principles of Reflection Seismics and to explain the basic fundamentals.

Knowledge of the lectures “Allgemeine Geophysik I und II” is indispensable.

Knowledge of the lecture “Digitale Verarbeitung seismischer Signale” is an advantage.

The topic reflection seismics is that large that only for some parts an extensive mathematical discussion is carried out. Therefore, this lecture only discuss qualitatively several topics which are important for the reflection seismics. An extensive treatment of specific processing steps and the mathematical background will be treated by “Praktikum zur Datenverarbeitung in der Reflexionsseismik”.

1.1 What is Reflection seismics?

In seismics, the geology is examined using seismic waves. The aim is to recognize geological structures and, if possible, to determine the material properties of the subsurface.

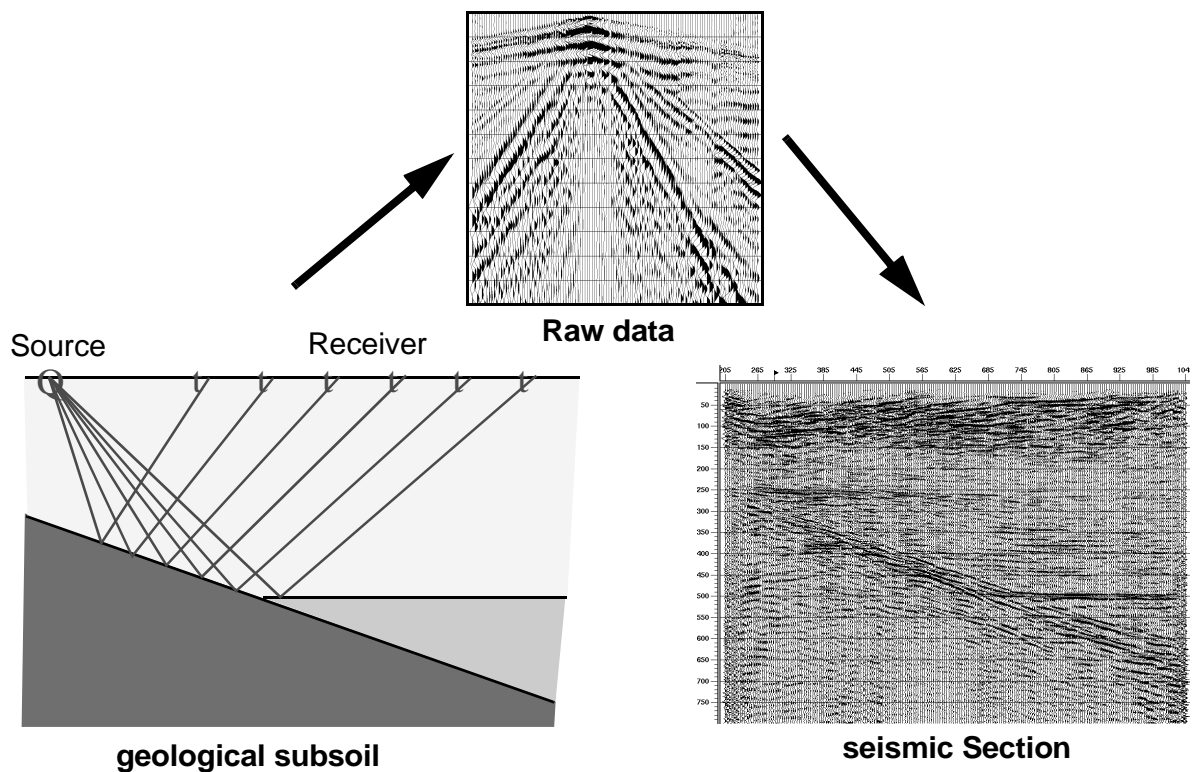

1.2 Historical Developments

Table 1: Historical development of reflection seismics(Sheriff and Geldart, 1995)

1914	Mintrop's mechanical seismograph	1954	Continuous velocity logging
1917	Fessenden patent on seismic method	1955	Moveable magnetic heads
1921	Seismic reflection work by Geological Engineering Co.	1956	Central data processing
1923	Refraction exploration by Seismos in Mexico and Texas	1961	Analog deconvolution and velocity filtering
1925	Fan-shooting method Electrical refraction seismograph Radio used for communications and/or time-break	1963	Digital data recording
1926	Reflection correlation method	1965	Air-gun seismic source
1927	First well velocity survey	1967	Depth controllers on marine streamer
1929	Reflection dip shooting	1968	Binary gain
1931	Reversed refraction profiling Use of uphole phone Truck-mounted drill	1969	Velocity analysis
1932	Automatic gain control Interchangeable filters	1971	Instantaneous floating-point amplifier
1933	Use of multiple geophones per group	1972	Surface-consistent statics Bright spot as hydrocarbon indicator
1936	Rieber sonograph first reproducible recording	1974	Digitization in the field
1939	Use of closed loops to check misties	1975	Seismic stratigraphy
1942	Record sections Mixing	1976	Three-dimensional surveying Image-ray migration (depth migration)
1944	Large-scale marine surveying Use of large patterns	1984	Amplitude variation with offset Determining porosity from amplitude DMO (dip-moveout) processing
1947	Marine shooting with Shoran	1985	Interpretation workstations
1950	Common-midpoint method	1986	Toiving multiple streamers
1951	Medium-range radio navigation	1988	S-wave exploration Autopicking of 3-D volumes
1952	Analog magnetic recording	1989	Dip and azimuth displays
1953	Vibroseis recording Weight-dropping	1990	Acoustic positioning of streamers GPS satellite positioning

1.3 Use of Reflection seismic

Reflection seismic tools are used in many different ways. Depending on the aim and the use different depth of penetration and resolution are obtained.

Also Applications which do not belong to the area of the classical seismic use reflection seismic principles (e.g. Georadar, echolot). A lot of principles (traveltime curves, filters etc.) can be used for these applications.

Table 2: Application of reflection seismic (and other)

	Aim	Penetration Depth
Oil/gas	Exploration of layers	100 m - 5 km
Engineering geophysics	Groundwater Pollution Archaeological investigation	10-500 m
Earth Crust seismic	Composition of Earth/Geodynamic	1-60 km
Measurements in water	Echo sounder, high resolution Seismics	~ 0 m <100 m
Georadar GPR	Shallow investigation of the Earth	0.5-10 m

2. Seismic waves

The basic of Seismics are the elastic waves, which include both P- and S-waves
Acoustic waves include only P-waves (in water)

(1) Body waves:

P-Waves (also Longitudinal- oder compression waves)

S-Waves (also Transversal- oder Shearwaves)

(2) Surface waves exist on the interface between two different media:

Rayleigh-Waves (Surface seismic wave propagated along a free surface of a semiinfinite medium)

Love-Waves (Surface seismic channel wave SH wave)

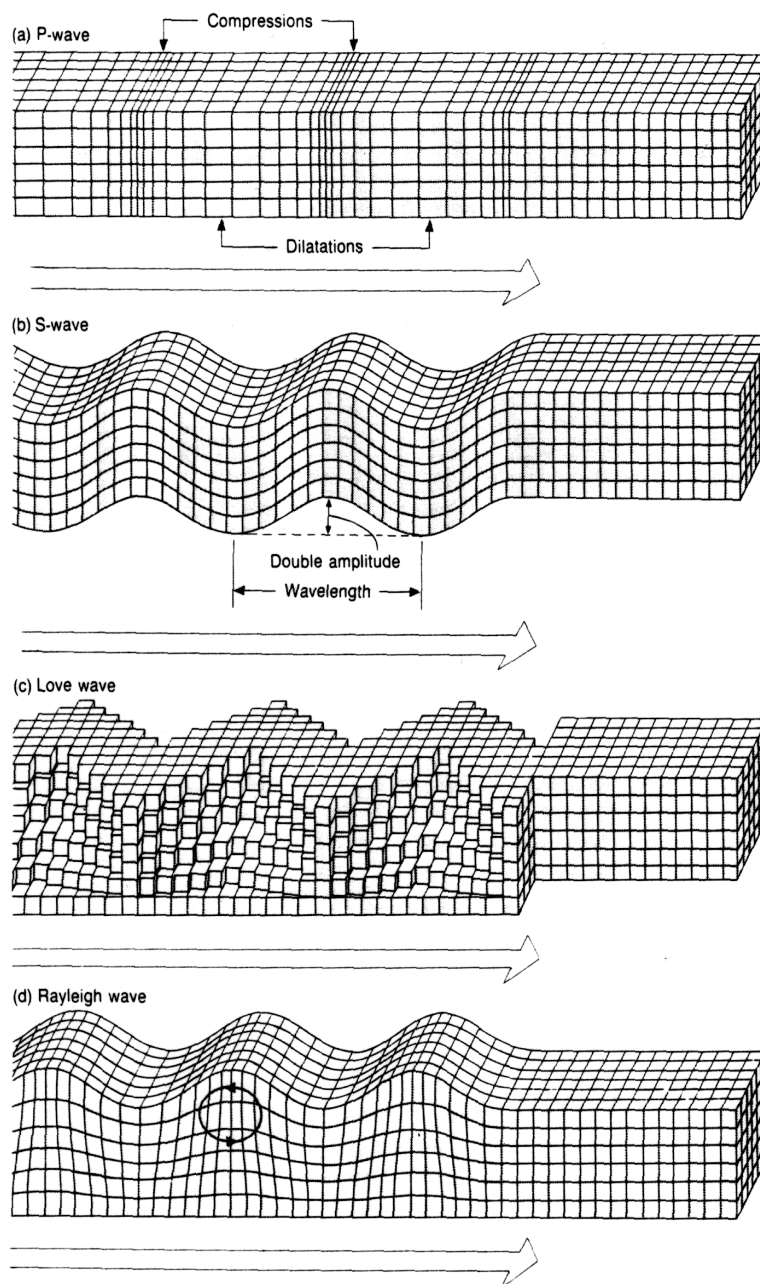

Propagation of different waves

2.1 Principles of wave propagation

The propagation of seismic waves is described by the wave equation. This wave equation can be derived from the relation between tension, elasticity, Hook's law and Newton's law. In three dimensions the derivation of this wave equation is quite complicated. This is why a simplified medium is assumed which exists only in one dimension. Newton's (second) law (in one dimension) is given by

$$\frac{\partial}{\partial z}P = -\rho \frac{\partial^2}{\partial t^2}U_z$$

where P is the acoustic pressure and U_z is the displacement and ρ is the mass density. The well-known formula $F=m \cdot a$ can be recognised in this equation and describes that a force acting on a certain mass results in an acceleration of that mass.

Hook's law is given by

$$\frac{\partial}{\partial z}U_z = -\kappa P$$

where κ is the compressibility and relates the stress (force per unit area) and strain (change of dimensions or shape). The bulk modulus k is the reciprocal of the compressibility and is given by

$$k = \frac{1}{\kappa}$$

Combining these two equations we obtain the Acoustic wave equation:

$$\frac{\partial^2 P}{\partial z^2} - \frac{1}{v^2} \frac{\partial^2}{\partial t^2} P = -w(t)\delta(z)$$

$w(t)$ is the source signal and v is the wavespeed which is given by

$$v = \frac{1}{\sqrt{\rho\kappa}} = \sqrt{\frac{k}{\rho}}$$

We will not use these expressions for the wave equation, because for most topics treated in this lecture, it is sufficient to consider the wave equations in a geometrical way, as wavefronts or as rays. The wave equation is mainly used for modelling and inversion of seismic waves. It will be shown that the wave velocities depend on the compressibility and the density.

2.2 Interface: Reflection, Refraction, Conversion.

When a wave encounters an interface three phenomena can occur:

- (1) Reflection
- (2) Refraction
- (3) Conversion

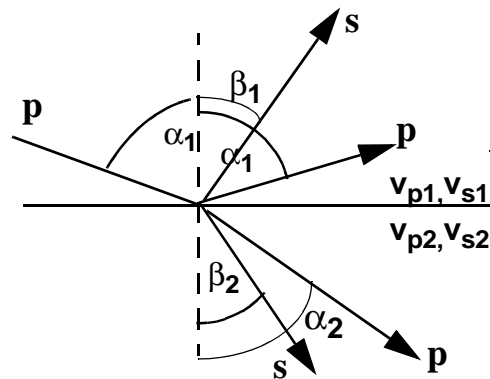

Interface: α =Angle of P-Waves, β =Angle of S-Waves.

Reflection

- Angle of incidence = angle of reflection ($\alpha_1 = \alpha_2$)

Refraction (change of direction of a seismic ray upon passing into a medium with a different velocity.)

$$\frac{\sin \alpha_1}{\sin \alpha_2} = \frac{v_1}{v_2}$$

- Critical angle: $\alpha_2 = 90^\circ$, the refracted ray grazes the surface of contact between two media

$$\frac{\sin \alpha_1}{\sin 90^\circ} = \sin \alpha_1 = \frac{v_1}{v_2}$$

Conversion

- Change at the interface of p->s or s->p
- As well as refraction as reflection is possible.

Law of Snellius

For all events at an interface the ratio, $\frac{\sin \alpha}{v}$ is always the same.

This ratio is also called the **Raypath parameter p**. The general Form of Snell's law is given by:

$$\frac{\sin \alpha_1}{v_{p1}} = \frac{\sin \beta_1}{v_{s1}} = \frac{\sin \alpha_2}{v_{p2}} = \frac{\sin \beta_2}{v_{s2}} = p = \text{const}$$

2.3 Reflection- and transmission-coefficients

To derive the reflection and transmission coefficients for elastic waves, the boundary conditions at the interface are needed. These reflections coefficients depend on

- Difference in density
- Difference in velocity
- Angle of incident of the wave

and are described by the **Zoeppritz-Equations**.

The Reflection- and Transmissioncoefficient give the ratio between the incident amplitude A_0 , and the reflected (A_R) and transmitted (A_T) amplitude, respectively. In the special case of a incident wave perpendicular at an interface for a P-wave, a simple expressions for the reflection and transmission coefficient is obtained.

$$\text{Reflectioncoefficient: } = \frac{A_R}{A_0} = \frac{v_2\rho_2 - v_1\rho_1}{v_2\rho_2 + v_1\rho_1} = \frac{Z_2 - Z_1}{Z_2 + Z_1}$$

$$\text{Transmissioncoefficient: } T = \frac{A_T}{A_0} = \frac{2v_1\rho_1}{v_2\rho_2 + v_1\rho_1} = \frac{2Z_1}{Z_2 + Z_1}$$

The Product $Z = v\rho$ is introduced as the **acoustic Impedance**.

Sometimes the coefficients which describe the Energy and not the amplitudes are introduced as Reflection- und Transmissioncoefficients:

$$\text{Reflection coefficient: } E_R = \frac{(Z_2 - Z_1)^2}{(Z_2 + Z_1)^2}$$

$$\text{Transmission coefficient: } E_T = \frac{4Z_1Z_2}{(Z_2 + Z_1)^2}$$

Obviously the total amount of energy is the same before and after the reflection and transmission, so that : $E_R + E_T = 1$

In a general case these coefficients are depending on the angle of incidence. Moreover, also conversions between P- and S-waves occur at an interface. This results in complicated expressions which will not be discussed in this report.

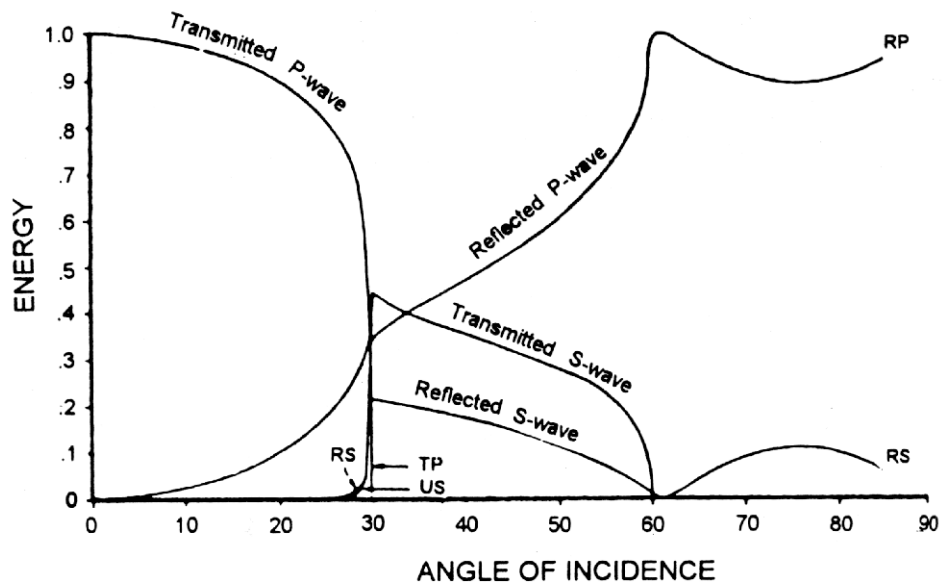

Angle-dependent reflection- and transmission-coefficients for P- and S-waves

2.4 Geometry of the wavepropagation

Observing the geometry of the rays, which travel from source to receiver, then the travel time can be derived (when the velocity and depth are known).

=> geometrical Seismic

Traveltime curve

The traveltimes of the different rays are plotted in an x-t diagram, a **Traveltime plot**. The picture below shows such a traveltime plot.

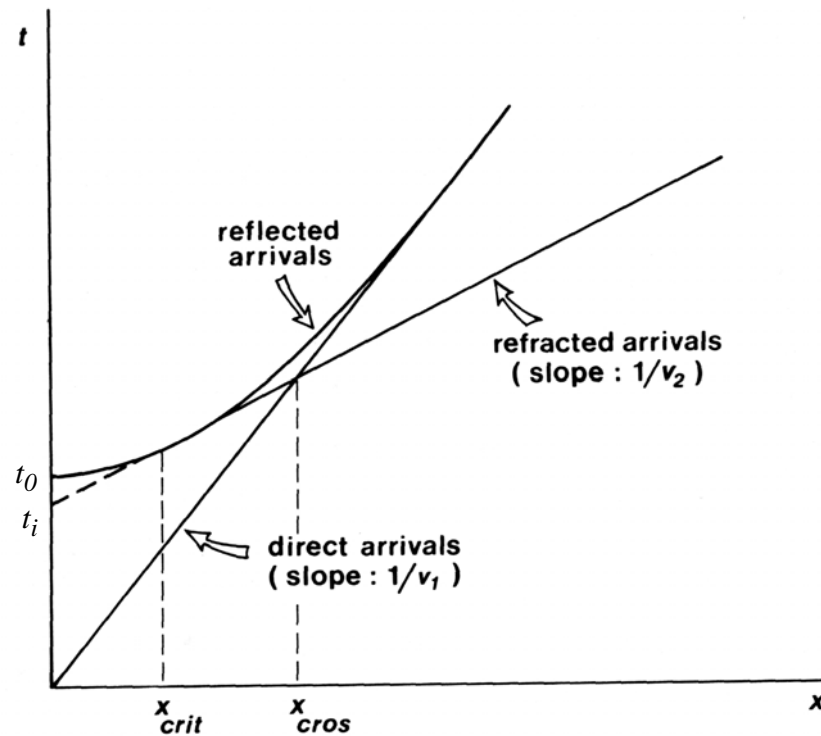

Picture of a typical travel time diagram for a two-layer case.

t_0 = t_0 -time of the Reflection; t_i = Intercept-time of the Refraction; x_{crit} = critical distance;
 x_{cross} = "cross-over"-distance.

The important rays in the travel time diagram are:

- Direct wave
- Reflected wave
- Refracted wave

The separate elements will be discussed in the following paragraphs:

Direct wave

The direct wave travels only in the upper layer, directly from the source to the receiver. When the upper layer has a homogeneous velocity distribution than we can assume that the wave travels parallel to the interface. In the traveltime diagram the direct wave shows a slope of $1/v$.

Reflected wave in the horizontal two-layer case

In Reflection seismic this signal is investigated and used. Therefore, we discuss this wave in more detail.

The simplest case is the horizontal two-layer configuration.

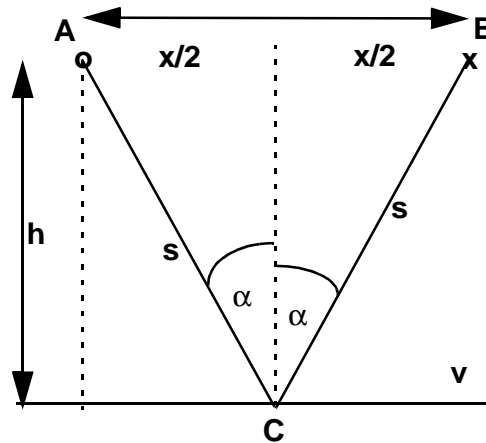

Schematic overview to calculate the traveltimes expressions for a reflection.

Using pythagoras we have:

$$s^2 = h^2 + \left(\frac{x}{2}\right)^2$$

which gives:

$$t^2 = \frac{4s^2}{v^2} = \frac{4h^2 + x^2}{v^2}$$

Rewriting last equations renders:

$$\frac{v^2 t^2}{4h^2} - \frac{x^2}{4h^2} = 1$$

This is the expression for a hyperbola. The traveltimes of a reflected wave goes for large x asymptotically towards the traveltimes of the direct wave.

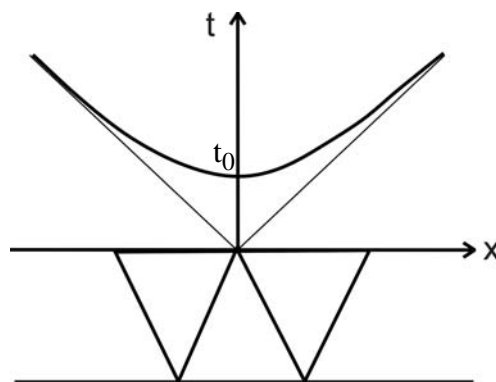

The crossing with the time-Axis ($x=0$) is the timezero, t_0 :

$$t_0^2 v^2 = 4h^2 \quad \Rightarrow \quad t_{(x=0)} = t_0 = \frac{2h}{v}$$

With the t_0 -time the expression for the travelttime can be written as:

$$t^2 = \frac{x^2}{v^2} + t_0^2$$

Moveout

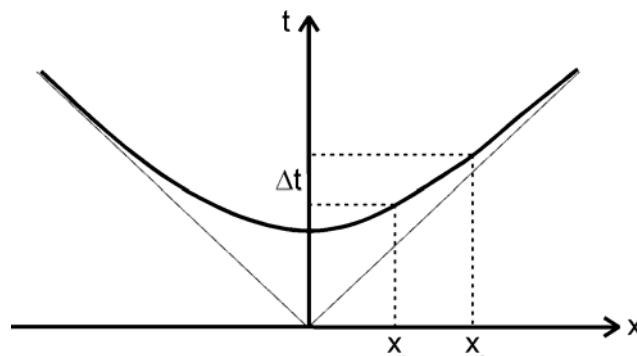

Rewriting the former equation,

$$t^2 = t_0^2 \left(1 + \frac{x^2}{t_0^2 v^2} \right)$$

.and using a binomial expansion of the square root we obtain an approximate expression for the

$$t = t_0 \sqrt{\left(1 + \frac{x^2}{t_0^2 v^2} \right)}$$

$$t = t_0 \left(1 + \frac{x^2}{2t_0^2 v^2} \right) = t_0 + \frac{x^2}{2t_0 v^2}$$

moveout in time between two different positions x_1 and x_2 .

$$t_2 - t_1 = \frac{x_2^2 - x_1^2}{2t_0 v^2}$$

Normal Moveout

The difference between the traveltimes t for a specific receiver at a specific distance x and a receiver at zero-offset $x_0=0$ is given by the normal moveout which is defined as:

$$\Delta T = t_x - t_0 \approx \frac{x^2}{2v^2 t_0}$$

This formula will later be used in the processing of seismic data.

Reflections - horizontal layered medium

When more than two layers are present the rays of the reflections are more complex. With the help of Snell's law the rays can be constructed iteratively..

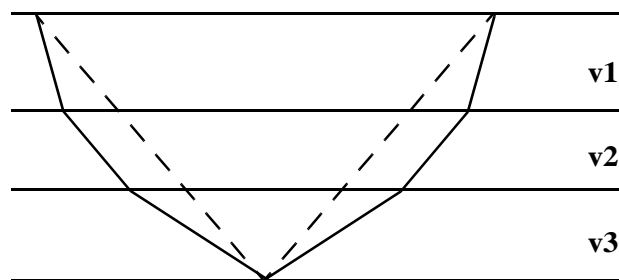

Three horizontal layers as example for a layered horizontal medium. The solid line represents the real travel path, where the dashed line represents the travel path of one layer with equal travel time.

It is possible to replace the expressions with the expressions for the one layer case when for the layers above the actual reflection point an average velocity is assumed.

A possible average velocity is given by.

$$v_{\text{average}} = \frac{\sum_{i=1}^n v_i \Delta t_i}{\sum_{i=1}^n \Delta t_i}$$

where z_i is the thickness of the i^{th} layer, t_i is the interval travel time through the i^{th} layer and v_i is the velocity of the i^{th} layer.

A better approximation is obtained when instead of the arithmetic average, the arithmetic average is taken of the square of the velocities (“**root-mean-square - rms**”).

$$v_{\text{rms}}^2 = \frac{\sum_{i=1}^n v_i^2 \Delta t_i}{\sum_{i=1}^n \Delta t_i}$$

The so-called RMS-velocity is used for all velocity analysis of reflection data, because it is relatively easy to obtain it from a seismogram.

To calculate the interval-velocities from the RMS-velocities, the Formula of Dix is used:

$$v_i = \left[\frac{v_{\text{rms}_n}^2 t_n - v_{\text{rms}_{n-1}}^2 t_{n-1}}{t_n - t_{n-1}} \right]^{\frac{1}{2}}$$

v_i is the intervalvelocity of the n th layer. t_n is the measured traveltime to the n th layer. When $t_n \neq t_{0n}$ we assume that the travel path to the individual reflections are equal. This is in general not correct. Dix' Formula then results in wrong v_i - values.

Reflection from a dipping reflector

The reflectors in reality are often not horizontal but dipping.

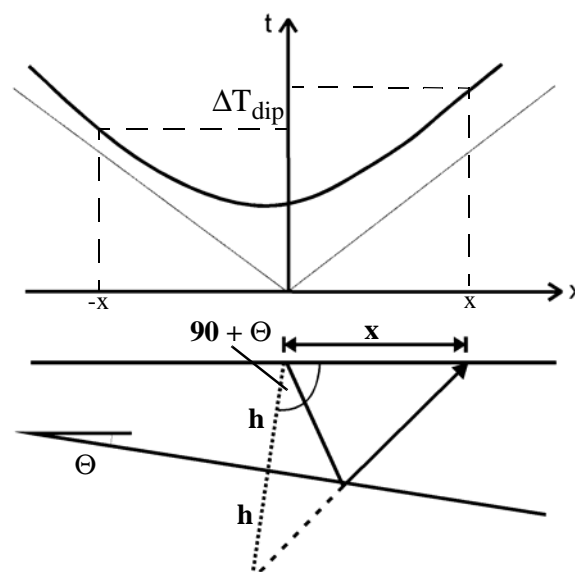

Ray path and traveltime diagram for a dipping Reflektor.

With the help of the cosinus rule an expression for the traveltimes can be derived as follows:

$$v^2 t^2 = x^2 + 4h^2 - 4hx \cdot \cos(90 + \Theta)$$

$$v^2 t^2 = x^2 + 4h^2 + 4hx \cdot \sin \Theta$$

The derivation of the next formulas for the dipping reflector follows analogue the case of the horizontal layer, with the exception that the expressions include a term with the angle Θ . We obtain a hyperbolic expression:

$$\frac{v^2 t^2}{(2h \cos \Theta)^2} - \frac{(x + 2h \sin \Theta)^2}{(2h \cos \Theta)^2} = 1$$

Where the symmetry axis does not lie on the t -axis, but is now the line $x = -2h \sin \Theta$.

$$v^2 t^2 = (2h \cos \Theta)^2 + (x + 2h \sin \Theta)^2$$

$$t^2 = \frac{(2h)^2}{v^2} \left[1 + \frac{(x + 2h \sin \Theta)^2}{4h^2} \right]$$

(Where $\cos \Theta$ is assumed to be 1 for small angles). After expansion as a binomial expression we obtain:

$$t = t_0 \left[1 + \frac{x^2 + 4hx \sin \Theta}{4h^2} \right]^{1/2}$$

$$t \approx t_0 \left[1 + \frac{x^2 + 4hx \sin \Theta}{8h^2} \right]$$

where t_0 is given by

$$t_0 = \frac{2h}{v}$$

The traveltime from two locations x and $-x$, that both have the same distance from the shot position is not equal anymore caused by the dipping reflector. The traveltime difference between both points is called the “**dip-moveout**”.

$$\Delta T_{\text{dip}} = t_x - t_{-x} = \frac{2x \sin \Theta}{v}$$

Refraction - horizontal Two-layer case

For a horizontal two-layer case the following situation is given:

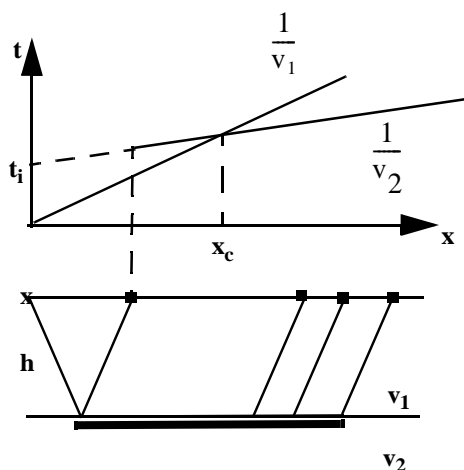

Horizontal two-layer case with the rays and the traveltime diagram above. The slope of the Refracted wave is $1/v_2$.

For the horizontal two-layer case the traveltime is given by:

$$t = \frac{x}{v_2} + \frac{2h \cos \Theta_c}{v_1}$$

or with $\sin\Theta_c=v_1/v_2$,

$$t = \frac{x}{v_2} + \frac{2h\sqrt{v_2^2 - v_1^2}}{v_1 v_2}$$

where

$$t = \frac{x}{v_2} + t_i$$

and t_i die **Intercept-Time** is. That is the time, that the Refracted wave the time axis crosses.
The “**crossover distance**” x_c , the distance at which the travel time of the direct wave and the refracted wave is equal is derived as follows:

$$\frac{x_c}{v_1} = \frac{x_c}{v_2} + \frac{2h \cos \Theta_c}{v_1}$$

and solving this for x_c gives:

$$x_c = 2h \sqrt{\frac{v_2 + v_1}{v_2 - v_1}}$$

Note that again $\sin\Theta_c=v_1/v_2$ is used.

3. Seismic Velocities

The velocities is the most important parameter in the reflection seismic. Information about the velocities is important for :

- Change of travelttime with depth
- Check of the seismic data with a model
- Correct for the geometry (Migration)
- Classification and filtering of signal and noise
- Geological and lithological Interpretation

The seismic velocity depends on the elastic parameters as follows:

$$v_p = \sqrt{\frac{k + \frac{4\mu}{3}}{\rho}}$$

$$v_s = \sqrt{\frac{\mu}{\rho}}$$

with **k= Bulk modulus**
 μ = Shear modulus

From these equations we observe that:

- v_p is always larger than v_s
- In Liquidws, $\mu = 0 \Rightarrow$ no shear waves can propagate.

Poisson-Ratio

The ratio of v_p and v_s depend on λ and μ . This ratio is defined by the **Poisson-Ratio** σ defined:

$$\sigma = \frac{\lambda}{2(\lambda + \mu)}$$

and has values between $0 < \sigma < 0.5$ (0.5 is valid for fluids).

Seismic velocities and the factors influencing it.

In Reality the factors λ , μ and ρ depend in a complex way on different factors:

- Lithology (Matrix und Struktur)
- Depth
- Interstitial fluids
- Pressure
- Porosity
- Degree of compaction
- Cementation
- etc.

Most of these factors influencing the factors λ , μ and ρ are empirically determined.

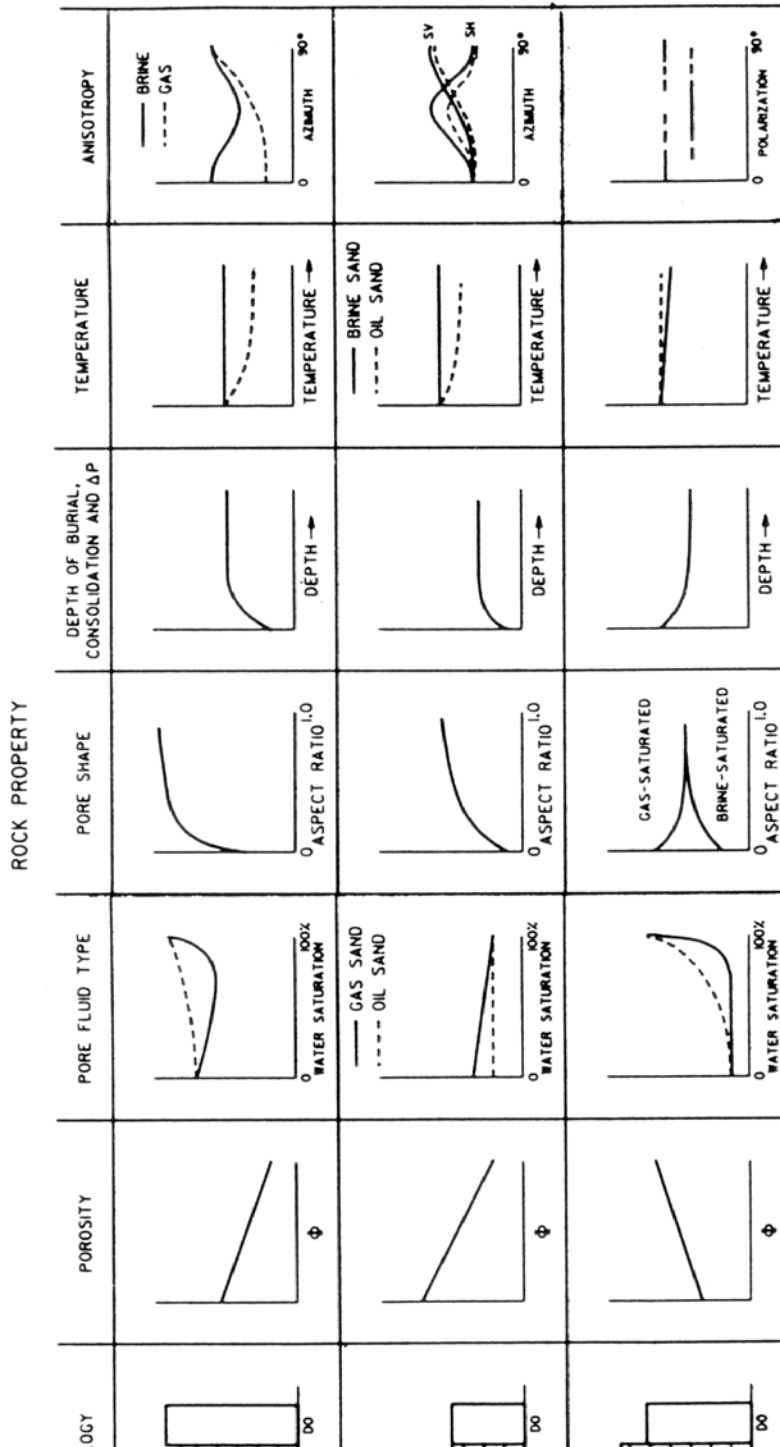

Beispiel für die Abhängigkeit von p- und s-Wellengeschwindigkeit von verschiedenen Parametern (Sherriff and Geldart 1995).

Examples for typical velocities

material	v_p (km s ⁻¹)
<i>Unconsolidated Material</i>	
Sand (dry)	0.2 - 1.0
Sand (water saturated)	1.5 - 2.0
Clay	1.0 - 2.5
Glacial till (water saturated)	1.5 - 2.5
Permafrost	3.5 - 4.0
<i>Sedimentary rocks</i>	
Sandstone	2.0 - 6.0
Tertiary sandstone	2.0 - 2.5
Pennant sandstone (Carboniferous)	4.0 - 4.5
Cambrian quartzite	5.5 - 6.0
Limestones	2.0 - 6.0
Cretaceous chalk	2.0 - 2.5
Jurassic oolites and bioclastic limestones	3.0 - 4.0
Carboniferous limestone	5.0 - 5.5
Dolomites	2.5-6.5
Salt	4.5 - 5.0
Anhydrite	4.5 - 6.5
Gypsum	2.0 - 3.5
<i>Igneous / Metamorphic rocks</i>	
Granite	5.5 - 6.0
Gabbro	6.5 - 7.0
Ultramafic rocks	7.5 - 8.5
Serpentinite	5.5 - 6.5
<i>Pore fluids</i>	
Air	0.3
Water	1.4 - 1.5
Ice	3.4
Petroleum	1.3 - 1.4
<i>Other materials</i>	
Steel	6.1
Iron	5.8
Aluminium	6.6
Concrete	3.6

(Kearey and Brooks, 1991)

Anisotropy

Seismic velocities in a solid can depend on the direction in which they travel within the solid. (for example Granite). This is the case when the matrix in the solid is direction dependent caused by for example gravitational forces .

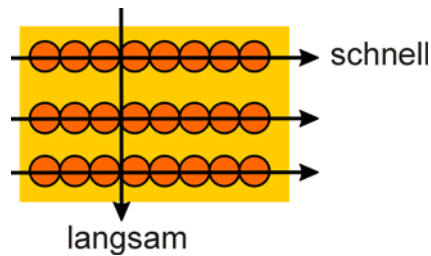

Anisotropy: A seismic wave travels faster in that direction where the matrix is more dense.

Direct measurements of the seismic velocity

Velocities can be determined when measuring the time, that a seismic wave needs to travel a certain distance. Direct measurements are carried out in a laboratory in a small probe or in situ in a borehole

Problem:

Many times higher frequencies are used to determine the seismic velocities. It is important that the velocity is frequency dependent, especially in a heterogeneous solid.

4. Amplitudes and Attenuation

The amplitudes of a seismic signal are influenced by several factors:

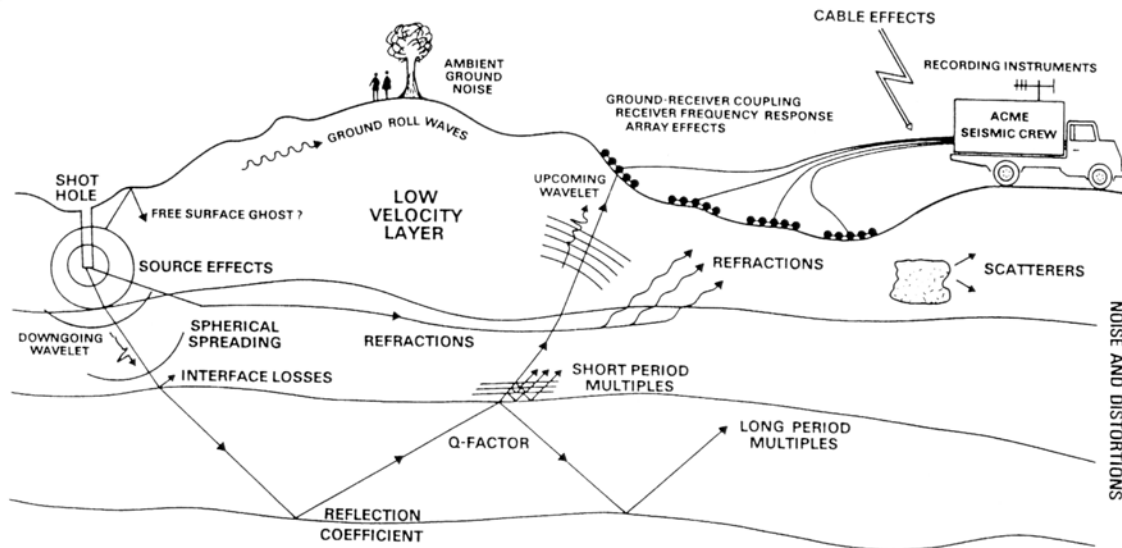

Phenomena causing the degradation of a seismic wave (Reynolds, 1998).

- Divergence
- Absorption
- Subdivision of Energie at an interface (Reflection, Refraction, Conversion)
- Interference with other waves(e.g. multiple Reflections)
- Spreading of Energie
- Influence of measurement system

Spherical divergence (geometrical spreading)

When a seismic wave propagates, the energy is spread along the surface of the wavefront. For cylindrical and spherical waves the surface increases with increasing radius. That is why the energy decreases. The Energy of the different waves are proportional to:

- plane Wave: konstant
- cylindrical Wave: $\sim 1/r$
- spherical Wave: $\sim 1/r^2$

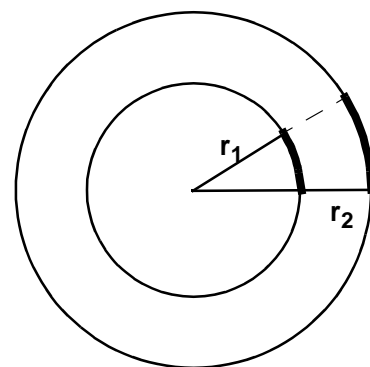

The energy of the body and interface waves are proportional to $(1/r)$ and $(1/r^2)$, respectively. The amplitude of the body and interface waves are proportional to $(1/\sqrt{r})$ and $(1/r)$, respectively (energy is proportional to (amplitude)²).

Absorption

When elastic waves travel through the subsurface, a part of their energy is dissipated in heat. The decrease of amplitude due to absorption appears to be exponential with distance for elastic waves in rock which can be written as:

$$A = A_0 e^{-\alpha x}$$

A and A_0 are the amplitudes at two locations with a distance x and α is the Absorption coefficient.

Quality factor Q

The absorption is often described by the Quality factor Q (Q-Faktor) described by:

$$Q = \frac{2\pi}{(\Delta E)/E} = \frac{2\pi}{\text{Fraction of Energie, lost per Cycle}}$$

The absorption coefficient α can be considered as a first approximation proportional to the frequency. We can write:

$$\frac{1}{Q} = \frac{\alpha v}{\pi f} = \frac{\alpha \lambda}{\pi}$$

This is only valid for Q larger than 1 (where v = Velocity and f = Frequency).

5. Measurement systems

5.1 Introduction

A seismic measurement systems in water and on land consist basically of three components:

- seismic source
- receiver
- Registration unit

5.2 Seismic Sources

The important properties of a seismic source are:

- Energie
- Frequencycontent
- Waveform
- Repeatability
- Resolution aspects
- Cost and use in the Field

Problem:

In general: The more energy is emitted the lower the frequency content. So a good compromise between penetration and resolution must be found.

Seismic source on land

- Impact: Sledge hammer, Drop weight, Accelerated weight
- Impulsive: Dynamite, detonating cord, Airgun, Shotgun, Borehole sparker
- Vibrator: Vibroseis Vibrator plate, Rayleigh wave generator

Seismic source in water

- Impulsive: Airgun, Gasgun, Sleeve gun, water gun, Steam gun, Pinger, Boomer, Sparker
- Vibrator: Multipulse, GeoChirp

5.3 Seismic Receiver

Similar to the source, special receiver are used for the measurement of the seismic waves on land and in water:

- **Geophone**- on Land
- **Hydrophone** - in Water

Geophone

Most of the geophones are based on the principle of a moving coil as in the picture below. The cylindrical coil is suspended in a magnetic field by a leaf-spring. The passage of a seismic wave at the surface causes a physical displacement of the ground which moves the geophone case and magnet in sympathy with the ground but relatively to the coil because of its inertia. This relative movement of the magnet with respect to the coil results in a small voltage being generated across the terminals of the coil in proportion to the relative velocity of the two components. Geophones thus respond to the rate of movement of the ground (i.e. particle velocity) not to the amount of movement or displacement.

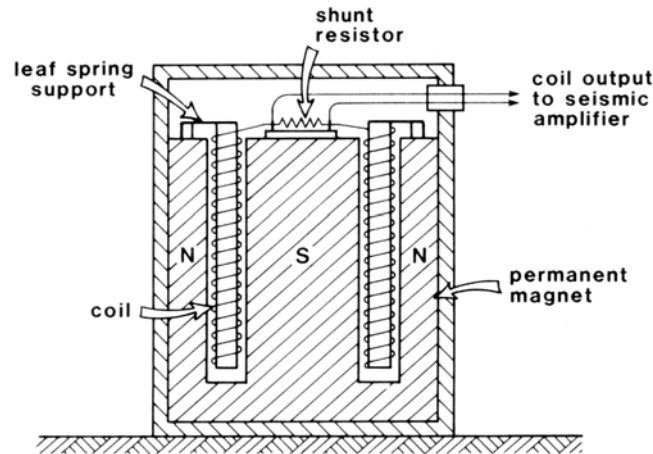

Typical geophone construction.

Problem:

The system is an oscillatory system with a resonant frequency depending upon the mass of the spring and the stiffness of the suspension. It oscillates strongly at the resonance frequency. This can be prevented by damping.

- undercritical Damping: Damping is too less, the geophone is not ready for the arrival of the next event.
- critical Damping: minimum amount required which will stop any oscillation of the system from occurring
- overcritical Damping: Signal has a large damping and is not sensitive enough for a measurement

Aim:

- Response in frequency domain should be flat (above natural frequency)
- Response in frequency domain should not have any phase differences.

Geophone-Group (Array)

To amplify the wanted signals and to suppress the unwanted signals like surfacewaves, more geophones are used in one group. The signal of the separate geophones are added to one signal for the whole geophone group. The directional response of any linear array is governed by the relationship between the apparent wavelength λ_a of a wave in the direction of the array, the number of elements n in the array and their spacing Δx .

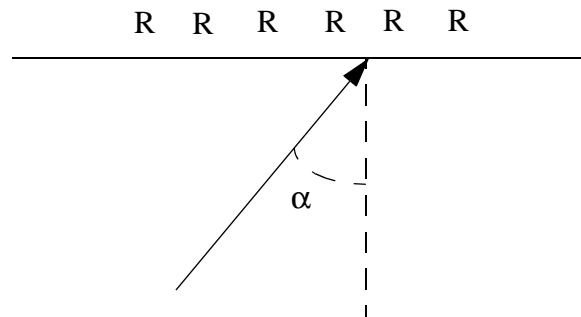

We define the apparent (horizontal) velocity for a ray, indicated by the arrow in the above picture as

$$v_{\text{app}} = \frac{v}{\sin \alpha}$$

and

$$\lambda_{\text{app}} = \frac{v_{\text{app}}}{f}$$

It can be seen that a wave travelling parallel to the interface at which the receivers (R) are located has an apparent velocity of v , while a wave traveling along the vertical (reflected from a deep interface) has an apparent velocity of infinity. This will result for the apparent wavelength $\lambda_{\text{app}} = \lambda$ and λ_{app} is infinity, respectively.

The response of a group of geophones is given by a response function R:

$$R = \frac{\sin n\beta}{\sin \beta} \quad \text{where} \quad \beta = \pi \frac{\Delta x}{\lambda_{\text{app}}} .$$

with n = number of geophones in one group.

The more geophones are used (n large) the more the range is in which the unwanted events are removed (range with small R)

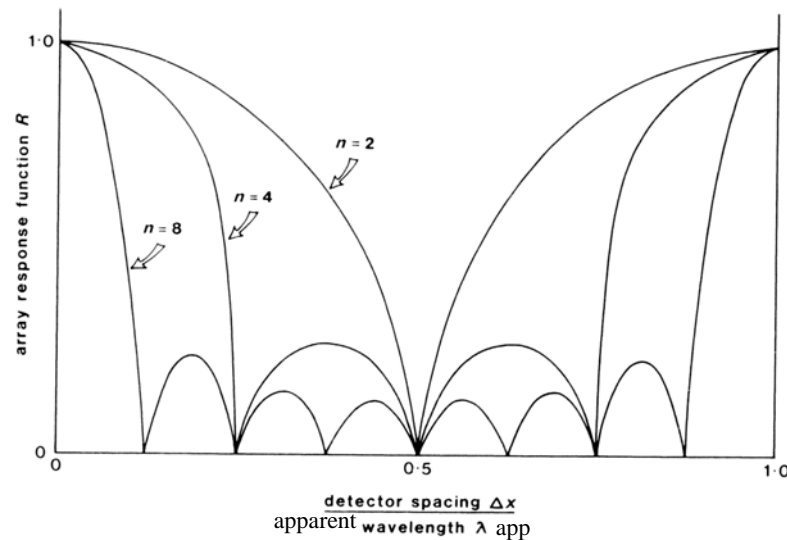

Response functions for different detector arrays depending on the ratio of the detector spacing and the apparent wavelengths for different numbers of geophones. (Kearey and Brooks, 1991).

To exemplify this, consider a Rayleigh surface wave (vertically polarised wave travelling along the surface) and a vertically travelling compressional wave reflected from a deep interface to pass simultaneously through two geophones connected in series/parallel and spaced at half the wavelength of the Rayleigh wave. At any given instant, ground motions associated with the Rayleigh wave will be in opposite directions at the two geophones and the individual outputs of the phones will therefore be out of phase and cancelled by summing. $\lambda_{app} = \lambda$ and $\Delta x = \lambda/2$ and $R=0$. Ground motions associated with the reflected compressional wave will, however, be in phase at the two geophones. λ_{app} is infinity and $R=1$. The summed outputs of the geophones will therefore be twice their individual output.

Special Geophone types:

- Horizontal-Geophone
- 3-Components-Geophone
- Landstreamer

Hydrophone

Hydrophone is the standard receiver in Marine seismic and responds to variations in pressure. It exist of a piezoelectric ceramic disc. A pressure wave effectively bends the piezoelectric discs, thus generating a voltage (see picture). This voltage is proportional to the variation of the pressure. Also the hydrophones are used in groups just like the geophones.

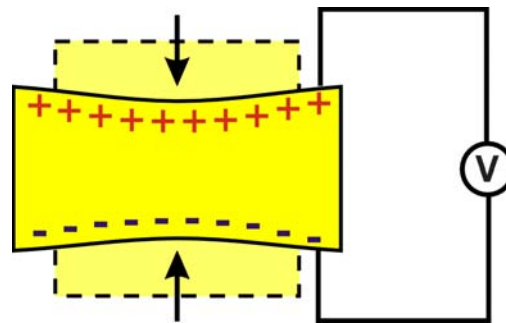

Principle of the measurement of the change in pressure with a piezoelectric crystal (Hydrophone). Due to the bending of the material a voltage occurs.

Streamer

In general several channels are used in Marine reflection seismic. Therefore, several hydrophones are fixed at a specific distance in a streamer. Close to the hydrophones a pressure sensor is present, which measure float depth, and if the streamer deviates from the required level the fin angles are adjusted to compensate.

Streamers are in general filled with a special oil, to adapt to the density of the water. Just like the measurements on land, several streamers with different lengths and different canals are used. From 48 canals with a length of 100 m. till 240 canals and a length of 12 km.

Special marine receivers

Besides the classical streamers there are also other systems used in marine seismic. Not always are long streamers used, for crust and wide-angle seismic, also 10 km is not long enough. When longer distances are needed only one receiver is used.

Sonobuoy

The simplest system is the Sonobuoy. The sonobuoy consists of a floating device containing batteries which, when in contact with seawater, are activated, causing a radio telemetering antenna to be raised and one or more hydrophones to be suspended on cables from below. When a shot is fired from the survey ship, the signals received by the hydrophones are radioed back to the ship where they are recorded. The offset between the shot and the sonobuoy is determined from the travel time of the direct wave through the water.

Ocean bottom -Hydrophone

Ocean-Bottom-Hydrophones (OBH's) are Hydrophone, that with a measurement tool and a weight are lowered on the bottom of the sea. There the signals of the hydrophones are continuously saved.

In general several OBH's are lowered on the seabottom (e.g. along a refraction profile). Then the measurements are carried out and several days later the OBH's are gathered and the data is read. By an acoustic signal the weight is uncoupled and the OBH comes to the seasurface by the use of a buoy.

5.4 Measurementsystem

Components of a measurementsystem

- Signal from geophone
- Preamplifier
- Filter

- (Multiplexer)
- A-D-converter
- Saving of the result.

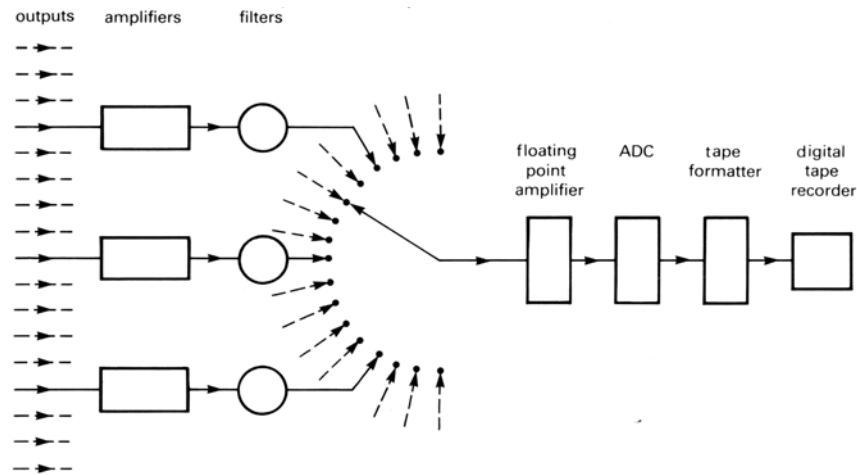

System, which registers a measurement of several canals with a multiplexer.

Sampling

By measurements with a digital system, the data is not continuously measured, but at a specific time interval measured and transported to the AD-converter.

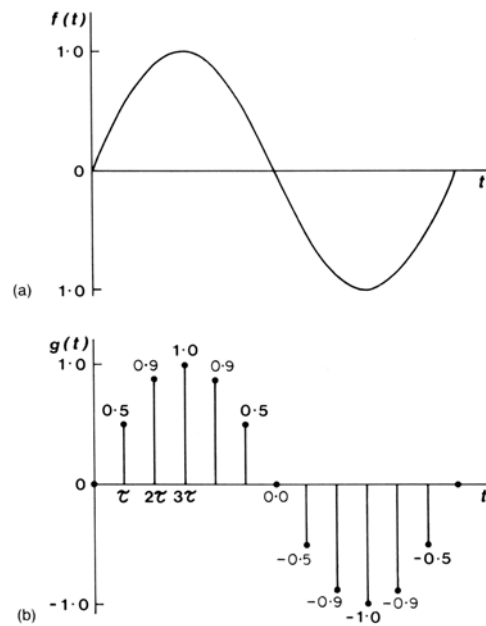

*(a) Analogue representation of a sinusoidal function
(b) Digital representation of the same function.*

Aliasing

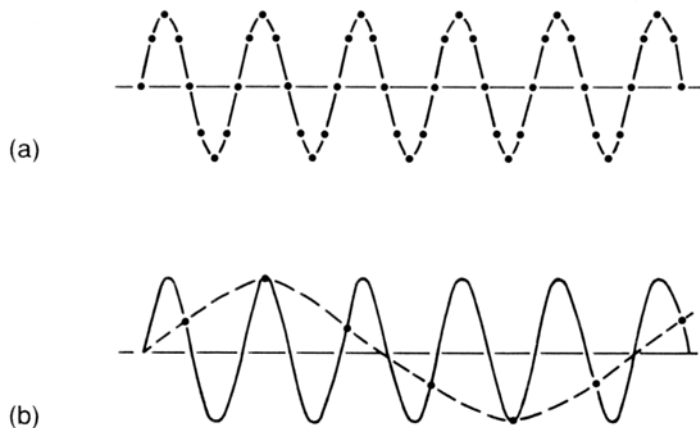

Principle of Aliasing:

(a) sine wave frequency less than alias frequency: no Aliasing

(b) Sine wave frequency greater than Nyquist frequency

Sampling frequency is the number of sampling points in unit time or unit distance. Thus if a waveform is sampled every two milliseconds (sampling interval), the sampling frequency is 500 samples per second (or 500 Hz). Sampling at this rate will preserve all frequencies up to 250 Hz in the sampled function. This frequency of half the sampling frequency is known as the Nyquist frequency (f_N) and the Nyquist interval is the frequency range from zero up to f_N

$$f_N = \frac{1}{2\Delta t}$$

No information is lost as long as the frequency of sampling is at least twice as high as the highest frequency component in the sampled data.

Seismic measurement systems have often an analog **Anti-Alias-Filter**, that suppresses all Frequencies above the Nyquist-Frequency.

Typical sampling distances are:

- 0.25 ms, 0.5 ms in the high resolution Seismic
- 1 ms, 2 ms in the Standard-Seismic (Oil-Exploration)
- 4 ms or larger in the Crust-Seismic

Digitizer (AD-Converter)

Im HiFi-Bereich setzt sich in zwischen mehr und mehr die digitale Speicherung der Daten durch. In der Seismik ist dies schon länger der Fall. Digitale Daten lassen sich durch Rechner und mathematische Operationen verarbeiten. Dazu muss das analoge Signal in ein digitales umgewandelt werden.

Every Bit (0 or 1) corresponds to a certain voltage, that each time differ with a factor two. The **A/D-Converter** compares the analogue signal with the different voltage steps and adds these in such a way that the smallest error between the analogue and digital signal occurs.

It is clear, that it is impossible to measure a signal which amplitude is larger than the sum of all separate steps or smaller than the smallest step. For a measurement, the gain must be set such that the amplitude of the measured data lies in the range of the AD converter.

We speak of 8-bit, 16-bit, 20-bit und 24-bit sampling:

Example:

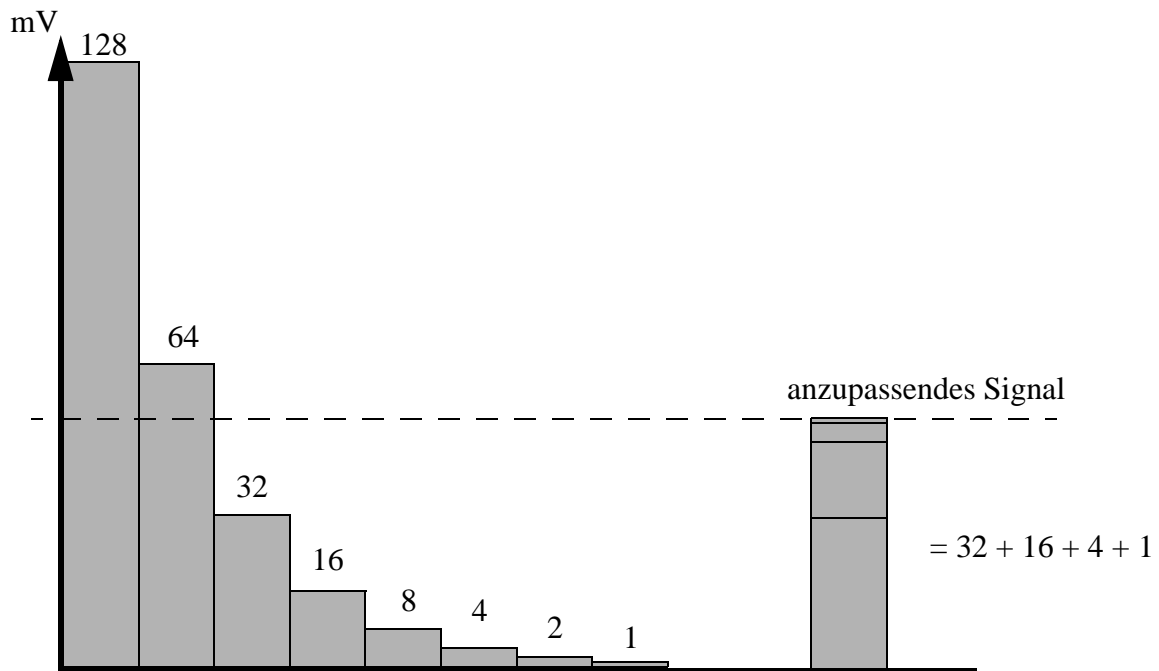

Funktionsweise eines Analog-Digital-Konverters

- 8-bit: 1 mV-256 mV
- 24-bit: 1 μ V-16 V

The **Dynamic range**, is defined as the ratio between the smallest and largest amplitude that can be distinguished. The **Dynamic range** is given in **dB** as follows:

$$\text{dB} = 20 \cdot \log\left(\frac{A_{\max}}{A_{\min}}\right)$$

Multiplexer

Older systems or systems with a lot of separate channels do not have for each separate channel a separate AD converter or enough writing capacity to save all data from one shot.

To solve this problem all the values at the separate channels are sampled for each time sample, after which all values for the next time sample are sampled and recorded. The data are not ordered for each channel (channel 1, channel 2 channel 3 etc.), but for each time sample (Timesample 1 - all channels, Timesample 2 - all channels, etc.). For the processing all channels must be sorted out which is called: **Demultiplexen**.

Saving of the data

The saving requirements are determined by the number of channels, the number of samples per channel and the number of bytes per value, which depend on the dynamic range or the format. and is often 4 Bytes per value.

For example when we have a sampling interval of 2 ms with a time window of 8 seconds, number of channels is 96 and need 4 bytes per value then we need:

--> $8000/2$ Values x 96 channels x 4 Bytes = 1536000 Bytes = 1.46 MByte

6. Acquisition setup

6.1 Single channel measurements (profiling)

Only one source and receiver are used with often an equal distance between the source and receiver. This is repeated for several positions along a line.

Typical Applications:

- simple marine System (Boomer, Sparker etc. --> Profiling)
- Georadar

6.2 Multi channel measurements

Multi channel systems use one source and several receivers, which measure at the same time. Several spreads are possible to orient the sources and receiver:

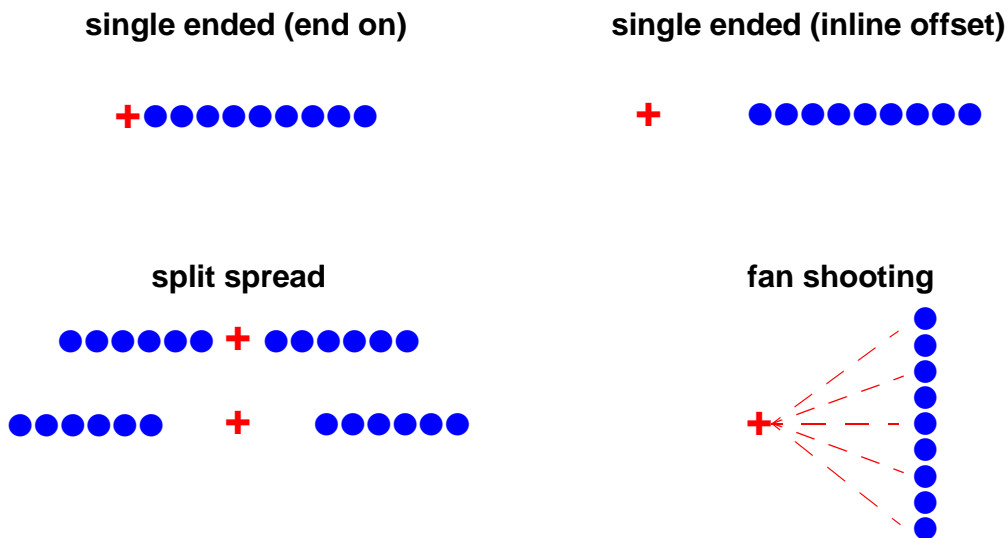

Types of reflection spreads. The symbol o and + represent source and geophone-group center locations, respectively.

“roll along”

In land seismic, often more geophones are put in the field than the measurement system can use. In this way the active channels can be connected when needed and there is no need to change the total field setup.

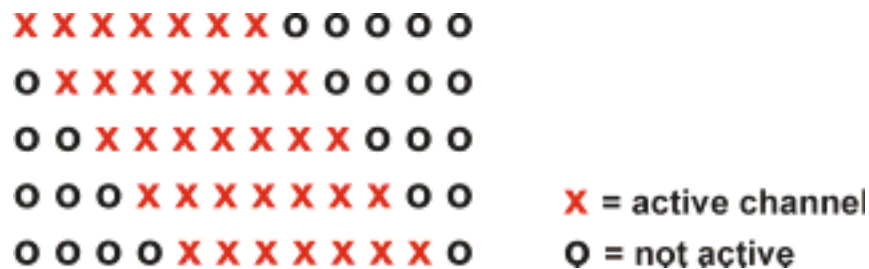

Principle of “Roll along” - Measurement

6.3 CDP, CMP and Zero-Offset, Common offset

There are different possibilities to sort the data:

- **Common shot** - all traces, that belong to the same shot
- **Common midpoint (CMP)** - all traces with the same midpoint
- **Common receiver** - all traces, recorded with the same geophone
- **Common offset** - all traces with the same offset between shot and geophone

Common mid point - CMP

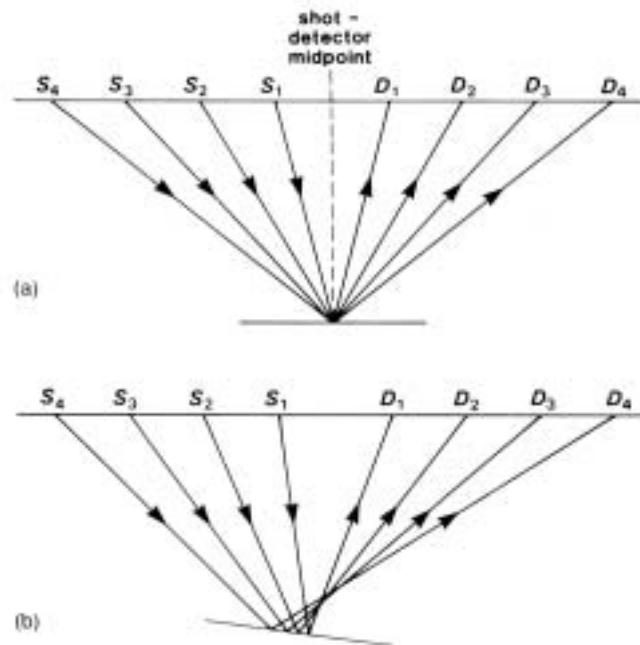

Difference between CMP and CDP: For a horizontal Reflector all traces that have the same midpoint, have also the same reflectionpoint in the subsurface. If the layer is inclined then the traces have a different reflectionpoint.

For a horizontal layered earth the reflectionpoint lies between source and receiver (midpoint). Using more shots with different positions of the source and receivers several combinations of source and receivers exist which have the same midpoint. When a horizontal layering is present the reflection then also comes from an equal point in the subsurface (Common depth point - CDP). For an inclined layer the point of reflection for traces with the same midpoint are not equal anymore. The nomenclature CDP is not valid anymore. However several processing programs still use the word CDP instead of CMP.

Zero offset

Zero offset data is characterised when the source and receiver are present on the same location. There is no moveout. For a normal measurement this is seldom the case. When the traces are corrected for the moveout and are stacked then a zero offset trace is obtained.

Common offset

All traces with equal offset between source and receiver. This configuration is often used for several Single channel systems. Also Georadar measurements are often carried out with a fixed offset between source and receiver.

Fold

The fold indicates the number of traces per CDP. This is often the number of traces in a CMP. The theoretical formula for the fold is given by:

$$\text{Fold} = \frac{\text{Number of Geophones} \cdot \text{Distance between Geophones}}{2 \cdot \text{Distance between shots}}$$

The number of traces which are measured at a certain geophone position is called “**surface fold**”

Crooked line method

Sometimes access and/or structural complications make it impossible to locate lines in desired locations. The field recording may be done in the same way as CMP surveying, except that the line is allowed to bend. Usually, a best-fit straight line is drawn through the midpoint plot, rectangular bins are constructed and those traces whose midpoints fall within a bin are stacked together. The bins are often perpendicular to the final line, but sometimes bins are oriented in the strike direction. Because the actual midpoint locations are distributed over an area, they contain information about dip perpendicular to the line and in effect produce a series of cross-spreads, from which the true dip can be resolved. Lines are sometimes run crooked intentionally to give cross-dip information.

3D-Seismic

The sources and receivers do not lie on a line, but in both horizontal directions sources and receiver are placed. In this way not only for different offsets, but also information from different directions (azimuths) is obtained. Here also bins are defined and all traces of the specific CMP are gathered after processing in that bin.

7. Seismogram

7.1. The seismic Trace

In Seismics we measure the amplitudes of the movement of the ground with time. Such a measurement is called a **Seismogramm** or seismic **trace**;

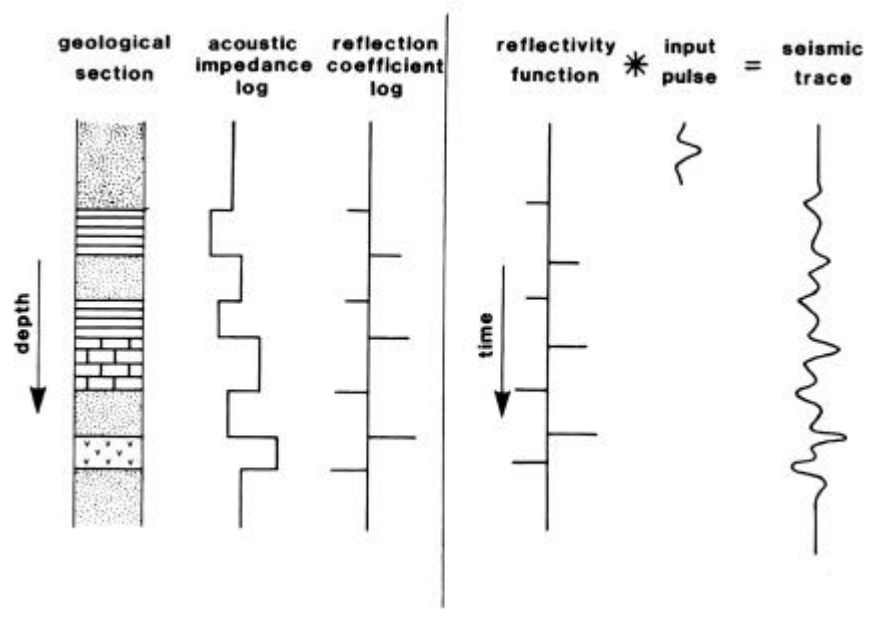

From a geological subsoil to a seismic trace.

The properties of the geological subsoil (density and seismic velocity) determine the acoustic impedance of a layer. From these impedances the reflectivity function of an interface can be derived (see Chapter. 2). This function is convolved with the signal of the seismic wave. The result is a seismic trace, on which also noise is add.

Remark: note that the wave travels half of the time downwards and the other half upwards. This must be taken into account when the source signal is convolved with the reflectivity function.

The principle of convolution is discussed more thoroughly when the data processing is discussed

Waveform

The most important waveforms in seismic are shown in the figure below and are the

- **Minimum-Phase** wavelet
- **zero phase** wavelet

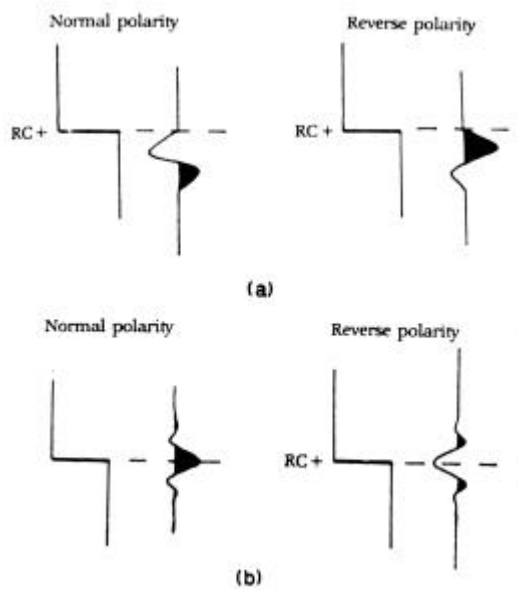

The most important waveforms in seismics: (a) Minimum-Wavelet und (b) Zero-Phase Wavelet. Both waveforms are shown with normal and reverse polarity.

Representation

In reflection seismic the travelttime is in general shown with increasing time along the vertical increasing downwards (larger travelttime corresponds to a larger depth).

There are several ways to represent seismic traces. The sort of representation depend on the processing used, but also on the number of traces.

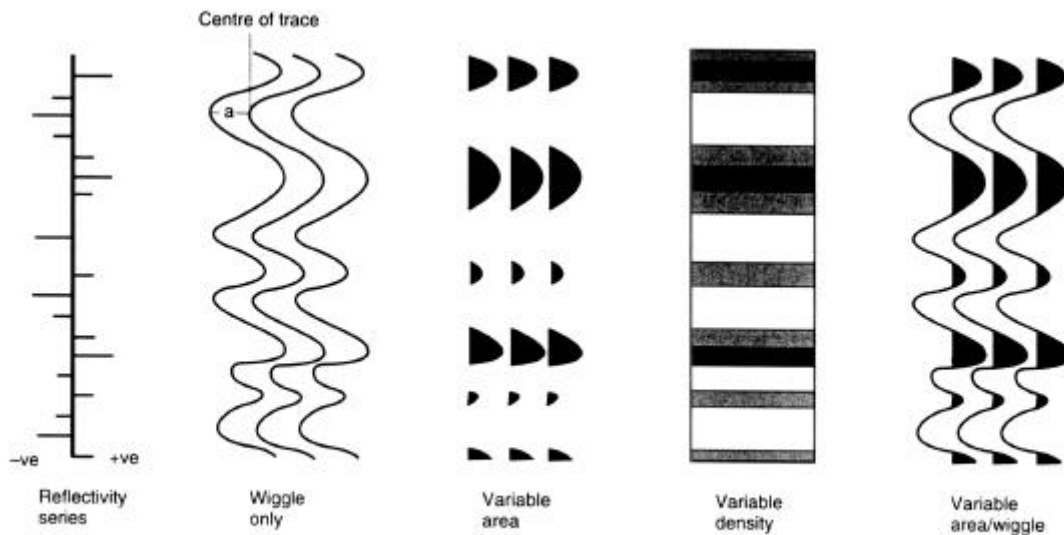

Different representations of a seismic trace.

“Wiggle”

For the simplest representation the amplitude is depicted as a curve (Wiggle).

“Variable area+wiggle”

When there are more traces then the result is disordered. The right half of the trace is drawn black. Standard (set by SEG) is: the positive half of the wave on the right site is colored black. This is in seismics the most used representation.

“Variable area”

When a lot of traces are depicted close to each other, then most of the time only the positive half of the traces is plotted. (e.g. for smaller version of seismic sections.). To suppress noise one often plot only a part of the half of the waves (**Variable Amplitude**).

“Variable density”

For the interpretation the amplitudes are often plotted in different grayscales or colours (“variable density”). This is standard for Georadar or seismic Interpretation. In this way the differences in amplitudes are more clear.

7.2 Seismogram of a shot**The important elements are**

- Reflections
- Refractions
- Interface waves
- Multiples
- Noise

Reflections, Refractions and interface waves are already discussed in Chapter 2.

Multiples

-> internal reflections in a layers, which occur when exceptionally large reflection coefficients are present.

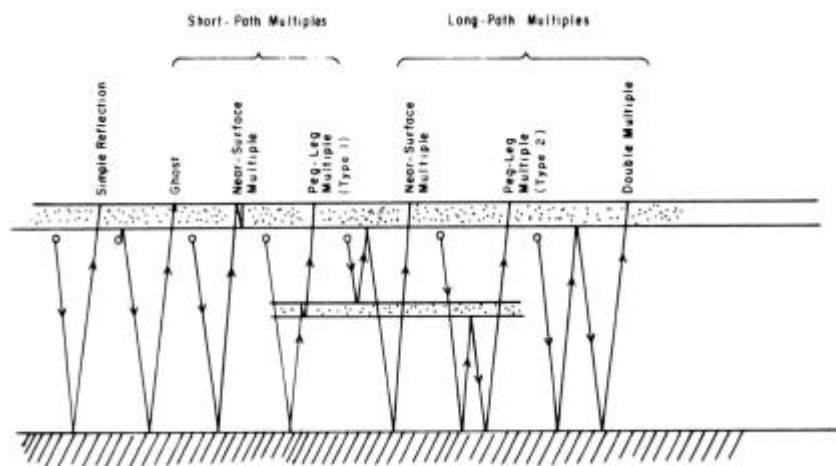

Example for the travelpaths of multiple reflections.

We distinguish:

- Multiples on the surface and
- Multiples between two interfaces of a layer (“peg-leg multiple”)

Noise

The S/N ratio “**Signal-to-noise ratio**” gives the ratio between the amplitude of a signal (e.g. Reflections) to background noise (“random noise”) or noise sources (“coherent noise”).

One aim of the dataprocessing is to increase the S/N ratio.

7.3. Resolution

Vertical resolution

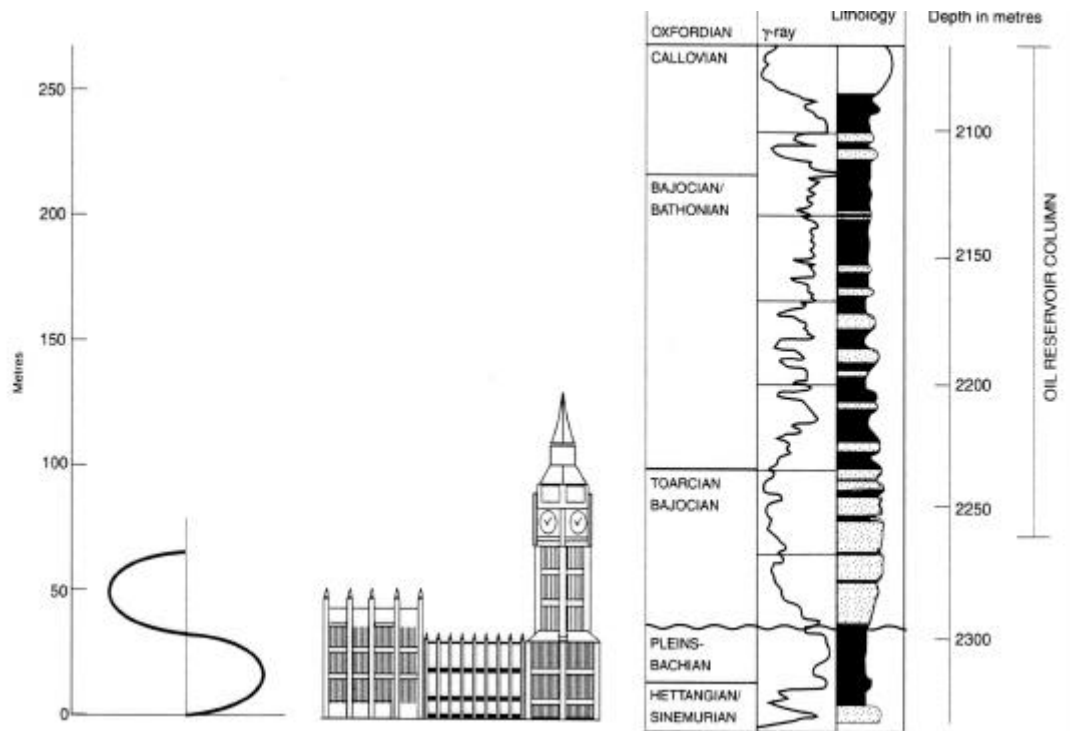

Comparison between the wavelength of a 30-Hz Signal, Big Ben and a Log of a drilling.

Vertical resolution means: How thick must a layer be, to discern the top and bottom of the specific layer. Theoretically, a layer can be distinguished when it has a thickness of 1/4 wavelength (**Rayleigh-Kriterium**).

The wavelength is determined by the ratio of the velocity and the frequency of the seismic wave:
 $\lambda = v / f$.

Lateral Resolution

The lateral resolution depends on the distance between the source and receiver at the surface and the depth of the layer. Energy that is returned to a detector within half a wavelength of the initial reflected arrival interferes constructively to build up the reflected signal, and the part of the interface from which this energy is returned is known as the first Fresnel zone, or, simply, Fresnel zone.

The width of the Fresnel zone represents an absolute limit on the horizontal resolution of a reflection survey since reflections separated by a distance smaller than this cannot be individually distinguished. The width w of the Fresnel zone is related to the dominant wavelength λ of the source and the reflector depth z by

$$w = \sqrt{2z\lambda}$$

for $z \gg \lambda$.

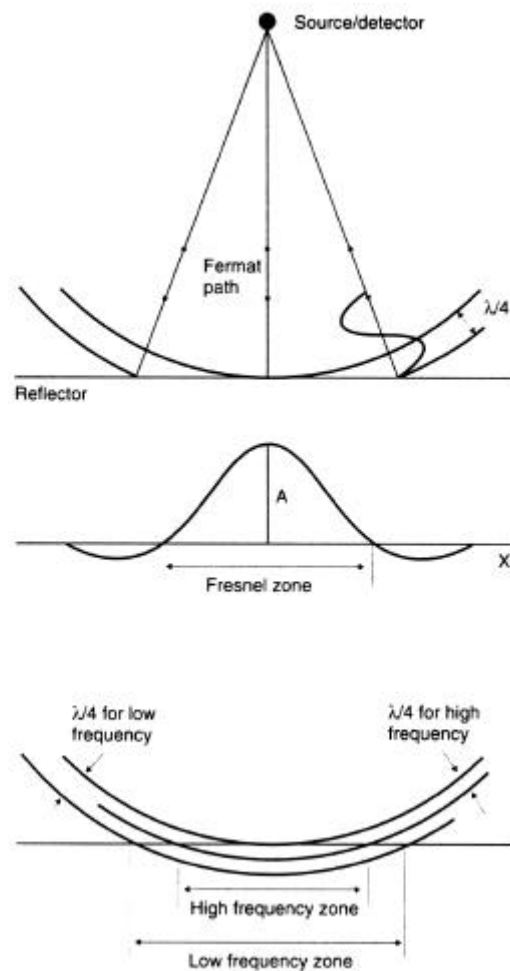

Principle of the Fresnel-Zone

8. Basic scheme for processing of reflection data

The aim of this lecture is to show the principles and their applications. The mathematics is only briefly discussed. More is discussed in Reflexionsseismik 2.

8.1. Aim of dataprocessing:

=> to obtain a representative image of the subsurface.

- (1) To improve the signal to noise ratio: e.g. by measuring of several channels and stacking of the data (white noise is suppressed)
- (2) To obtain a higher resolution by adapting the waveform of the signals
- (3) Isolation of the wanted signals
(Reflections isolated from multiples and surface waves).
- (4) Realistic image by geometrical correction
(Conversion from travelttime into depth and correction from dips and diffractions).
- (5) To obtain information about the subsurface(velocities, reflectivity etc.)

8.2. Basic framework for the data processing

We will discuss the different steps in more detail.

In principal two different types of processing steps can be distinguished:

- (1) **Ondimensional** Filter and Methods
These methods are employed on seperate traces.
- (2) **More dimensional** filter
These methods are employed on more traces e.g. CMP, Shotgathers or stacked sections.

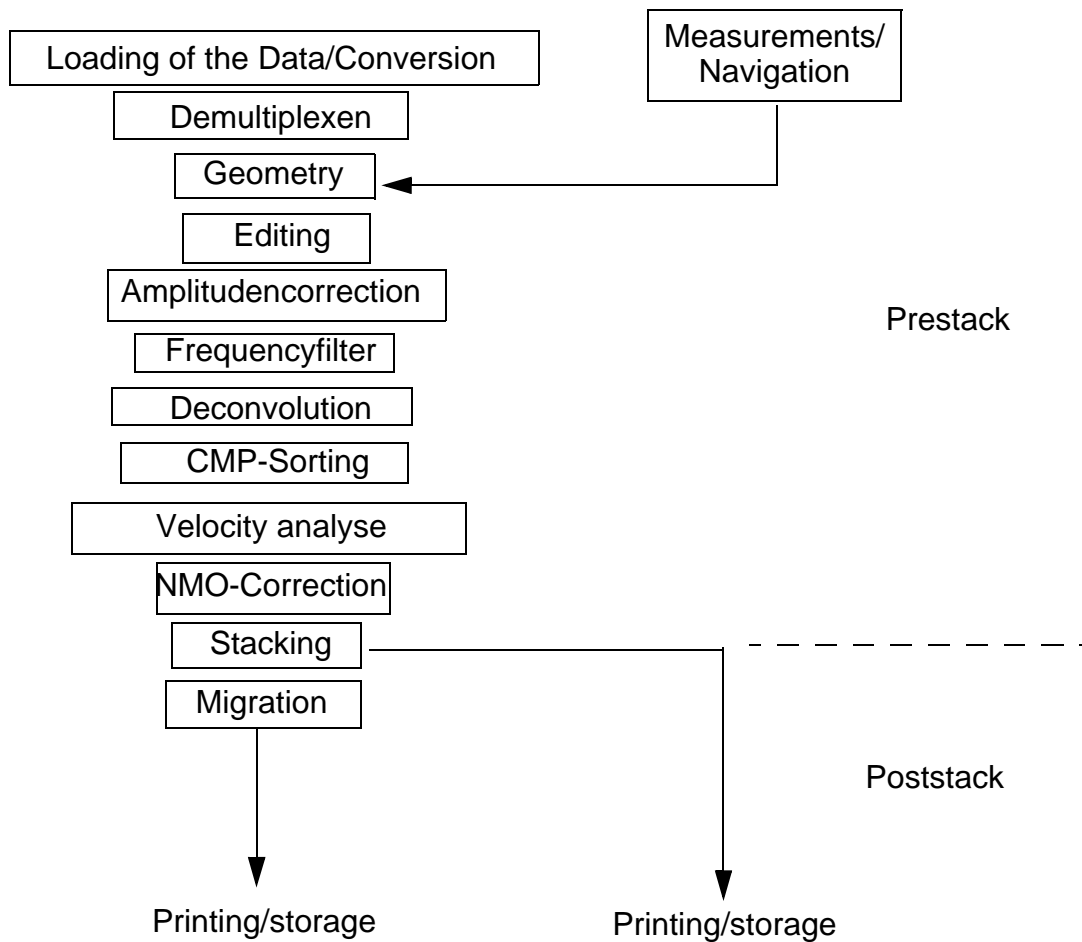

Basic scheme of the processing of seismic reflection data. The order of the different processing steps can vary. Additional processing steps can be added to improve the quality of the measured reflections.

9. Loading the data, demultiplexen, data-Format

9.1. Principle of Demultiplexing (Sorting of the data)

The principle of multiplexing is already discussed in the section measurement system. It is used when the capacities of the AD converter are not sufficient to digitize and save all channels at the same time. This is common for older measurement systems or for measurements with a large time window and a lot of channels per shot. The separate values of all channels are sorted by samples and not by channels:

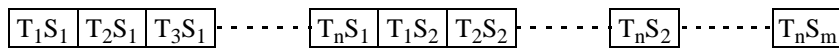

$T_i = \text{Trace } i; S_j = \text{Sample } j$

It is difficult to process the data in this form. It is more convenient and illustrative when the data is sorted by traces:

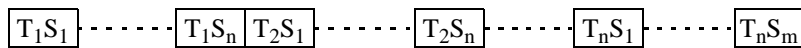

$T_i = \text{Trace } i; S_j = \text{Sample } j$

9.2. Dataformats

To deal with seismic data and their processing it is helpfull to know something about the dataformats which are used to store these data.

Almost every program and every large oil company has developed their own format. In the course of time there have been developed several standards, to make an exchange possible between the different programs. The most important standards are:

- SEG-Y**
- SEG-D**
- SEG-2**

SEG stays for *Society of Exploration Geophysicists*. This is the most important society of geophysicists and seismologists in the oil industry.

The different formats are very similar. The most important standard today is the SEG-Y format. Every file consist of several parts. The standard describes which information is put where in the file.:

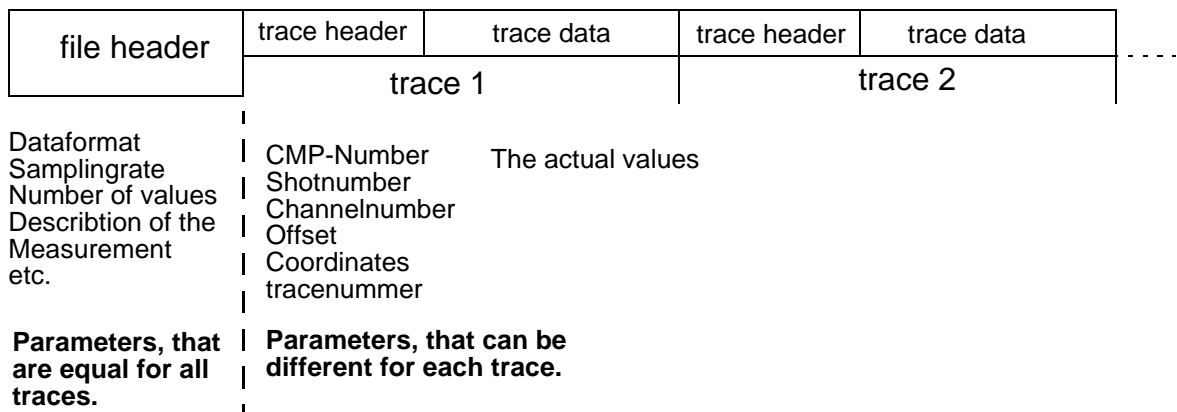

Structure of the SEG-Y Format

The other Formats SEG-D and SEG-2 are often used for the storage of raw data. They are suitable for multiplex data and make it possible to save traces with different lengths. E.g. the SEG2 format saves each shot separately.

Using digital storage, the way in which a certain value is saved, also different formats are used:

IBM-Reel (4-Byte floating-point, Standard)

IEEE (4-Byte floating-point)

4-Byte Integer

It is important to know that the storage of bytes at Intel-PC's differs from the storage at workstations or Macintosh computers. The important difference is that the bytes are swapped (also called "*byte-swapping*").

10. Amplitude Correction

10.1 Problem

As already discussed, the amplitude of a seismic signal decays with increasing travel time. To obtain a realistic image, this decay must be compensated for. In general, it is difficult to describe this amplitude decay analytically, so an approximation is usually made.

Methods to preserve amplitude information:

- Trace equalisation
- AGC (“Automatic gain control”)
- Correction for the spherical divergence
- Programmable gainfunctions

10.2 Trace equalisation

The simplest method is the normalisation of the different traces. All absolute values of a trace are summed and compared with a reference value. A scaling factor is determined from the difference between the summation and the reference value, which is used to multiply all data with.

Other possibilities for normalisation:

- Average value (arithmetic or RMS)
- Median
- Maximum Value

These methods compensate the difference in amplitude which occurs due to the increasing distance between the source and receiver. Also lateral differences in amplitudes are compensated for.

Loss in amplitude for increasing time (or depth) are not taken into account.

10.3 Automatic Gain Control - AGC

The AGC function does not employ a gain to the whole trace, but employs a gain to a certain time sample within a time gate. First, the mean absolute value of trace amplitudes is computed within a specified time gate. Second, the ratio of the desired rms level to this mean value is assigned as the value of the gain function. This gain function is then applied to any desired time sample within the time gate, say the n -th sample of the trace. The next step is to move the time gate one sample down the trace and compute the value of the gain function for the $(n+1)$ th time sample and so on.

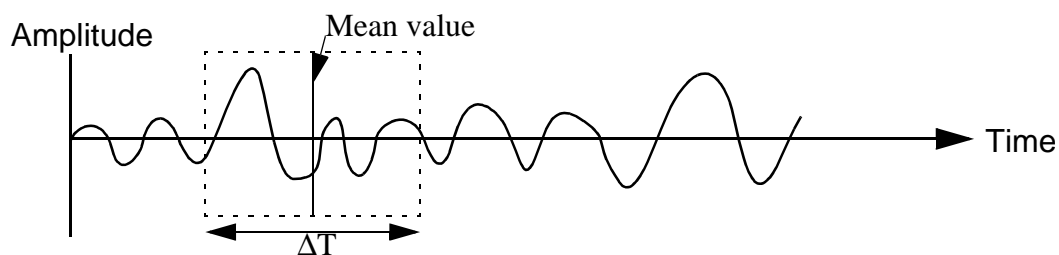

Principle of AGC

The time gate is very important. Very small time gates can cause a significant loss of signal character by boosting zones that contain small amplitudes. In the other extreme, if a large time gate is selected, then the effectiveness of the AGC process is lessened. In practise, 256- to 1024-ms AGC time gates are commonly chosen.

A disadvantage is that when the AGC gain is applied, it is not possible to reconstruct the original signal again. Therefor the AGC is only used for display and printing purposes.

10.4 Spherical Divergence Correction

The loss of amplitude, which occurs due to the spatial spreading of the wave, can be corrected for when the velocity is known. For a homogeneous space the amplitude decay can be written as $A(t)$, whereas the gainfunction $G(t)$ can be written as:

$$A(t) = \frac{1}{r}, G(t) = v \cdot t$$

In a layered space the amplitude $A(t_{tw})$ and gain $G(t_{tw})$ function can be written as

$$A(t_{tw}) = \frac{1}{[V_{rms}(t_{tw})]^2 t_{tw}}, G(t_{tw}) = \left[\frac{V_{rms}(t_{tw})}{v(0)} \right]^2 \frac{t_{tw}}{t_{tw}(0)}$$

where t_{tw} is the two way travelttime, $v(0)$ is the velocity value at specified two-way travelttime $t_{tw}(0)$.

In general, the seismic velocities are not known when the processing is started. To overcome this problem, approximate velocities are used. Later on, when a velocity analysis is carried out, the improved velocity model can be used.

This correction does not correct for the attenuation or loss due to transmission or conversion.

10.5. Programmable Gain functions (Time und Distance-dependent)

To correct for the general amplitude decay, programmable gainfunctions can be used.

It is assumed that the amplitude decay can be described by an exponentially damping function.

To correct for this exponentially damping, one uses gain functions like:

$$A(t) = A_0 k t^n e^{at}$$

where it is assumed that the amplitudes have a uniform amplitude distribution.

The amplitude decay is corrected by the exponentially increasing function as can be seen in the Figure below.

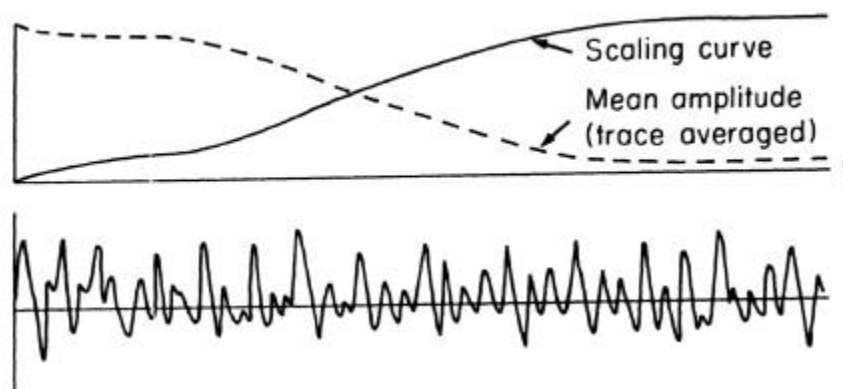

Scheme of a scaling curve, resulting in similar amplitude values along the trace.

Similar to a time-dependent gain functions, different offset-dependent gain functions are often used, so that simultaneously a time- and offset dependent gain is applied.

By using programmable gain functions, amplitude differences can disappear, when the actual gainfunction is not known anymore.

11. Filter (Frequency filter)

Frequency filter are the most important filters in digital signal processing. The energy of reflections are most of the time present in a certain frequency range. Specific noise sources and background noise are commonly present in a different frequency ranges and a separation of noise and reflection information is possible.

11.1 Fourier transformation

The basis of a digital frequency filter is the **Fourier transformation**. The principle of Fourier says that each signal can be described by a sum of Sinus- and Cosinus functions.

The Fourier transformation transforms a time queue from time domain (amplitude as function of time) to the frequency domain (amplitude as function of frequency).

Fourier transformation:

$$G(f) = \int_{-\infty}^{\infty} g(t) e^{-i2\pi ft} dt$$

Backtransformation:

$$g(t) = \int_{-\infty}^{\infty} G(f) e^{i2\pi ft} df$$

The Function in Frequency domain $G(f)$ represents the amplitude and the phasedifference of a Sinus or Cosinus function with the frequency f . We distinguish the **Amplitude spectrum $A(f)$** and the **Phasespectrum $\phi(f)$** :

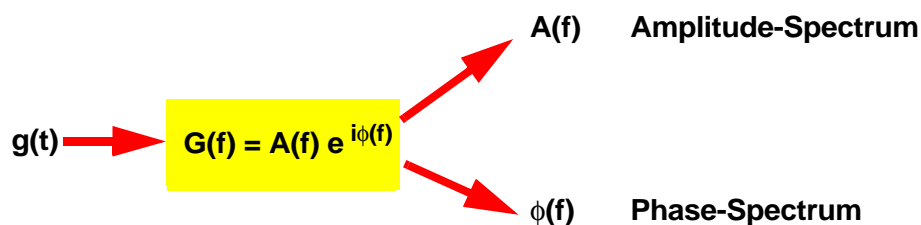

Because in frequency domain the data consists of an amplitude and phase (or real and imaginary part), often the amplitude spectrum of the energy, the "**Powerspectrum**" is shown. The Fourier transformation is numerically evaluated very efficiently by the **FFT** - the Fast Fourier Transform.

11.2 Spectrumanalysis

In seismics, we often now only roughly the interesting frequency range and the frequency range of any noise sources. To know what frequency range is interesting for further processing, the data must be tested with different filters and a comparison of these results indicate the interesting frequency range.

-

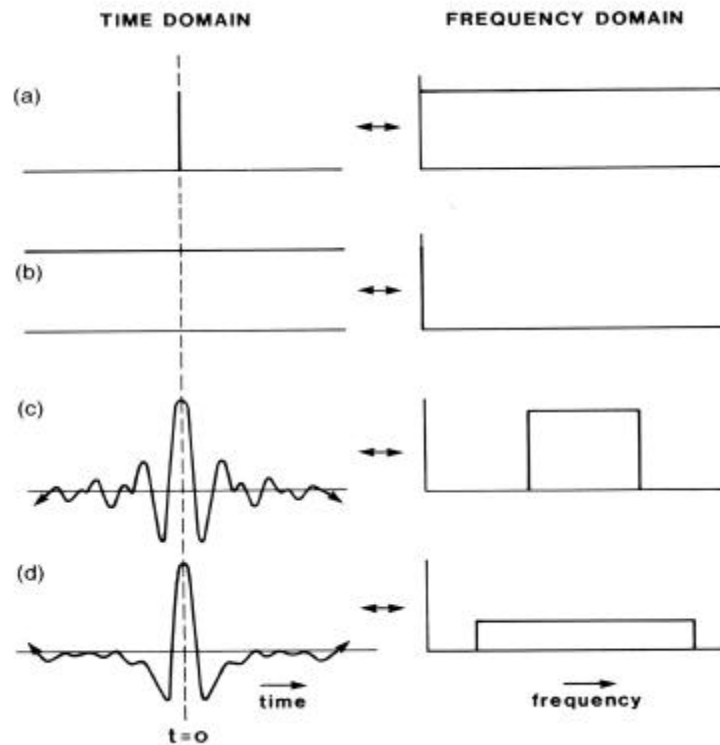

Examples of different signals and their Fourier transformation.

11.3 High cut, Low cut, Band pass filter

There are different type of filters:

- high cut, low pass
- low cut, high pass
- Bandpass
- Notch filter

Most filters are applied in the frequency domain. For example, using the Low pass filter, the amplitude of all frequencies above a certain frequency are put to zero. Similar filtering is applied for the High pass and Band pass filters

Notch-Filter

A notch-filter is used to suppress one specific frequency, for example 50-Hz-Noise due to electrical powerlines.

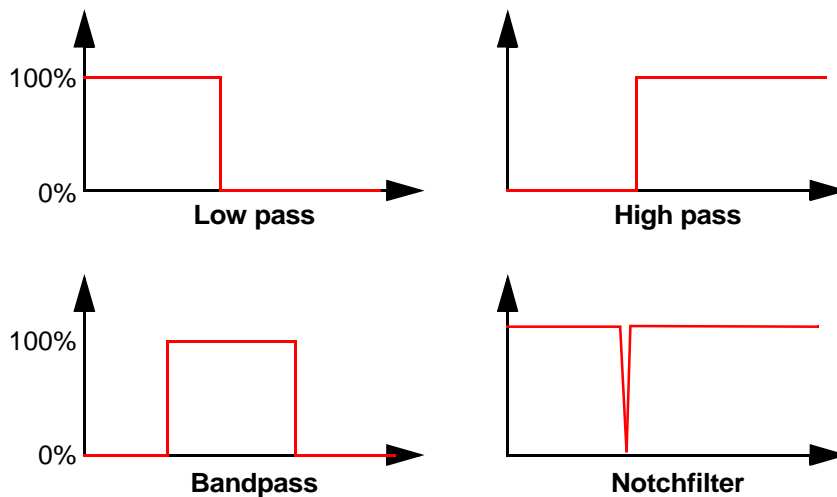

Examples of different type of filters.

Ringing

Ideal filters have very steep edges, which is in the ideal case discontinuous.

The result of such discontinuities is **ringing** (also known as Gibbs' phenomena) as can be seen in the figure below. In figure (a), the frequency domain result is present with a discontinuity at f_c . This discontinuity results in an oscillatory behaviour in the time domain as can be seen in figure (b). When a taper is used to make the transition more smooth at f_c (c), the oscillatory behaviour is less pronounced:

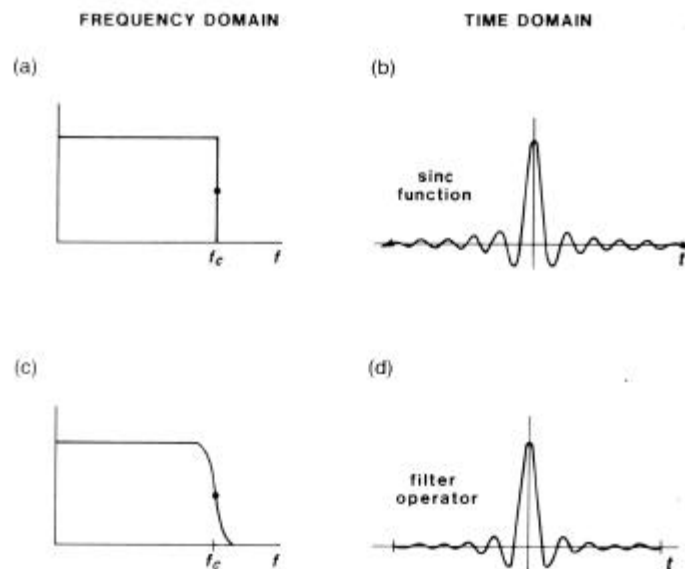

Principle of ringing which occurs in time domain when sharp boundaries are present in the frequency domain.

In practise, it is not possible to design a frequency filter which is discontinuous at the edges.

To define this tapering a slope is given as function of the frequency as follows:

- Two Frequencies in between the taper is present (Begin and End of the tapering)
- The slope of the taper is given as function of the Frequency in dB

Time-dependent Frequency filter

To take into account the larger decrease in amplitude for the higher frequencies for increasing travel time, a time-dependent frequency filter can be used. One defines different frequency filters for different timewindows.

12. Static Correction - Part 1 (Refraction)

12.1 Problem

Reflections in different traces are not always lying on a hyperbola for a horizontal reflector, but sometimes they have a certain displacement due to different lengths of the raypaths.

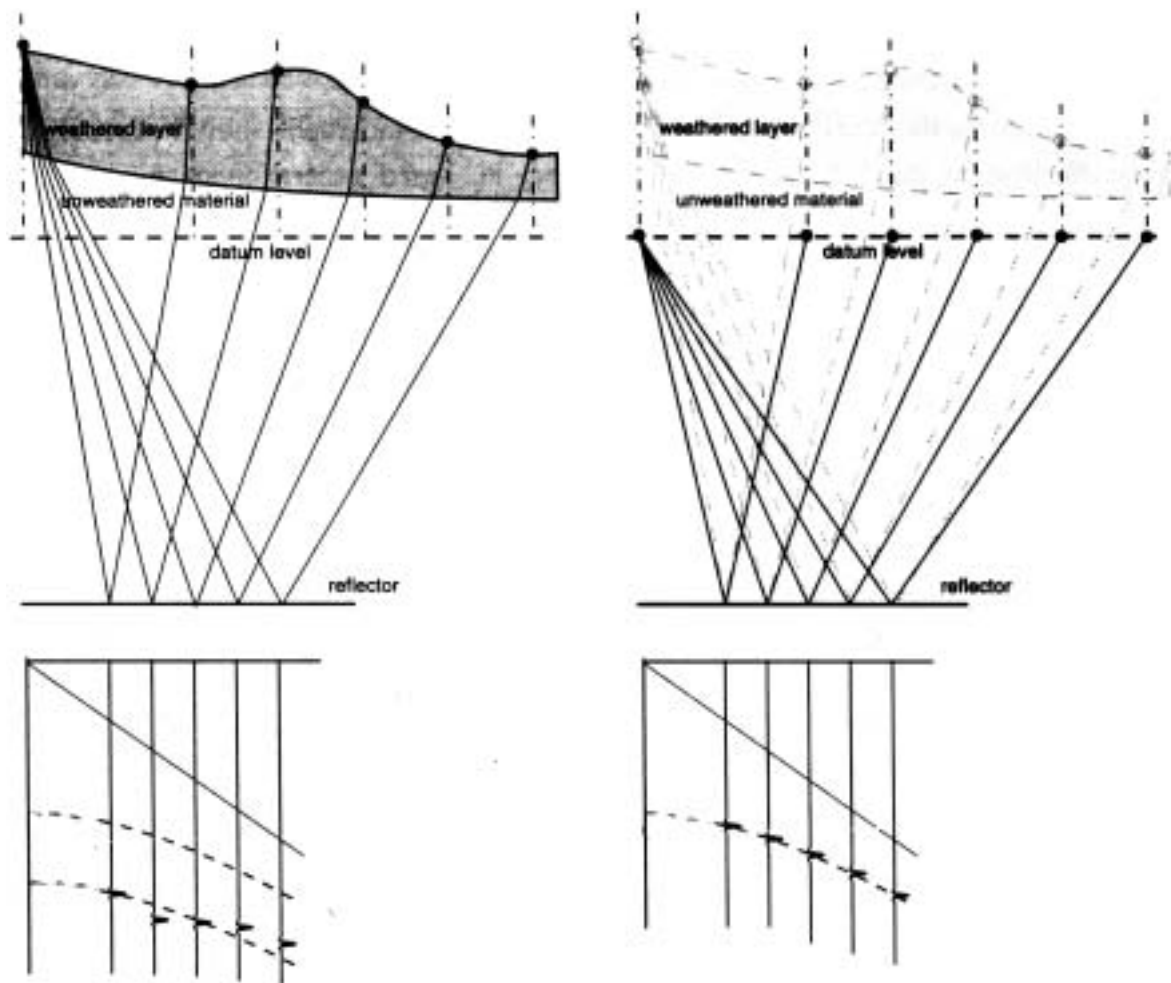

Effect of topography on measured data. The reflections are not lying on a hyperbola. After static corrections the reflection appears as if source and receiver had been positioned at the datum level (Brouwer and Helbig, 1998).

Causes for the static displacements in the data:

- Topography, i.e. Source and receiver are present at different vertical positions.
- Different depths of the boreholes in which the explosives were fired
- Weathered layer with a relative slow velocity.

Aim of static corrections

Adjust the seismic traces in such a way that the sources and receivers are present at one horizontal level. To achieve this, the travel times of the separate traces are corrected.

static Correction: The whole trace is corrected with the same time shift
dynamic Correction: Different time windows in the trace are corrected differently. This results in stretching and compression of the events (e.g. NMO-Correction)

12.2 Methods for static Correction

- Topographic Correction (elevation statics)
- “Uphole”-Correction
- Refraction statics

Topographische Korrektur

Vertical aligning of the different elevations of sources and receivers.

Shot-Static = (Elevation of source - Elevation of reference level) / Velocity.

Receiver-Static = (Elevation of receiver - elevation of the reference level) / Velocity.

Correction time for a trace = Shot-Static + Receiver-Static

“Uphole-Static”

=> Correction for the weathered (low velocity) layer.

When a shot is fired, also the travelttime to the surface is recorded and from this travelttime, the velocity of the weathered layer can be estimated.

Refraction statics

=>Correction for the weathered layer.

Using the first breaks of a certain shot (refracted energy) a model can be construced for the weathered layer (velocities and depth).

When the distance between the receiver is too large, sometimes supplementary refraction measurements are carried out

Methods to determine the velocity and depth of the weathered layer using refractions

- Delay-Time
- GRM (generalised reciprocal method)
- DRM (deminishing residual matrices)

All these methods return an averaged model. Very small displacements between the traces are not completely corrected for. For these small displacements corrections can be carried out which follow the stacking and the determination of a velocity model. These correccions are called **Reststatic** .

13. Deconvolution

13.1 Convolution

Convolution is a mathematical operation defining the change of shape of a waveform resulting from its passage through a filter.

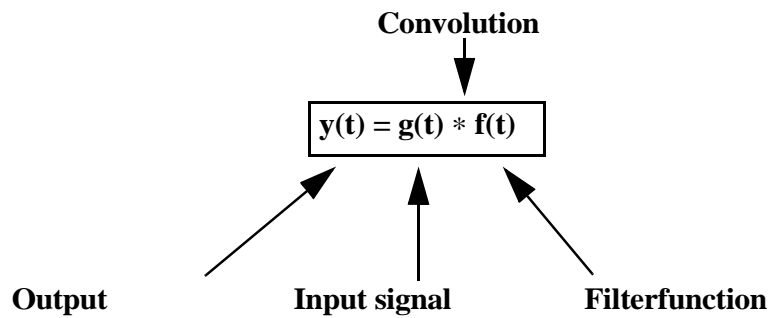

The asterix denotes the convolution operator. In seismics, we obtain a response for a certain model by convolving the seismic signal of the source with the reflectivity function.

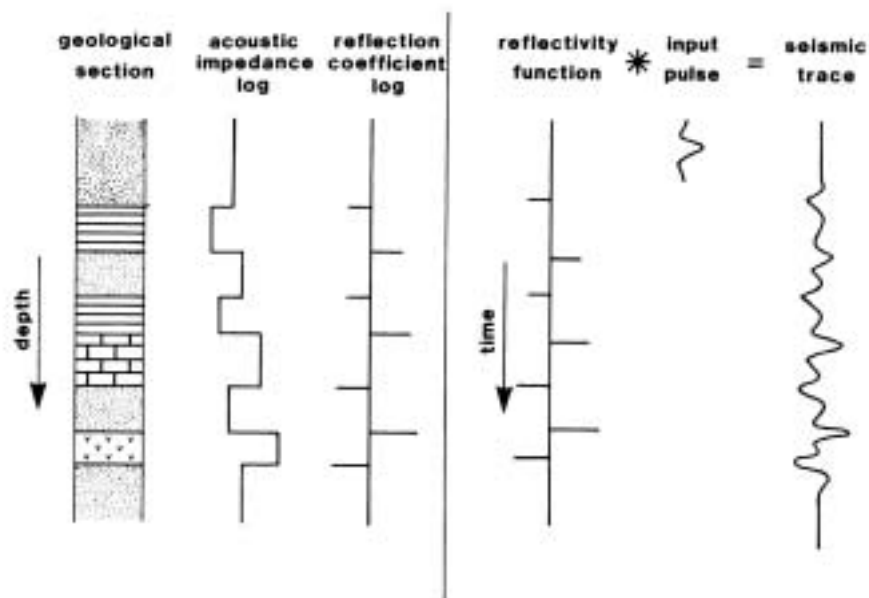

Convolution of the reflectivity function with the signal of the source returns the seismic trace.

In reality the measured signal g_t consists of the Convolution of several factors:

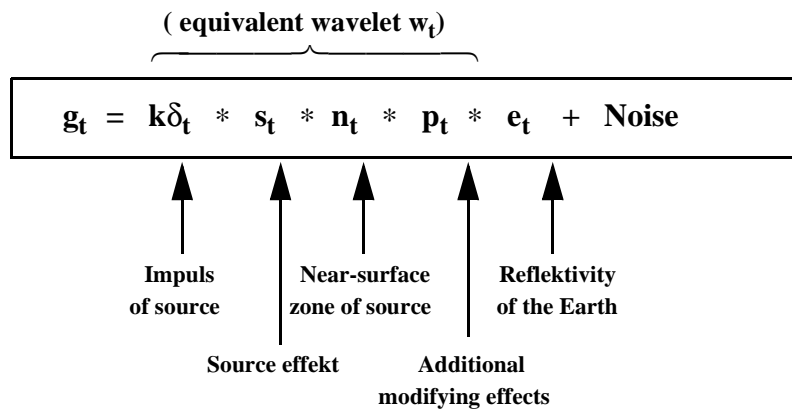

Mathematically the convolution is defined as follows:

$$y_k = \sum_{i=0}^m g_i \cdot f_{k-i}$$

where $k = 0 \dots m+n$; $g_i = (i=0 \dots m)$ and $f_j = (j= 0 \dots n)$.

The convolution can also be performed in the Fourier domain:

Convolution in time domain = Multiplication (of the Amplitudenspectrum and Addition of the Phase spektrum) in Fourier domain.

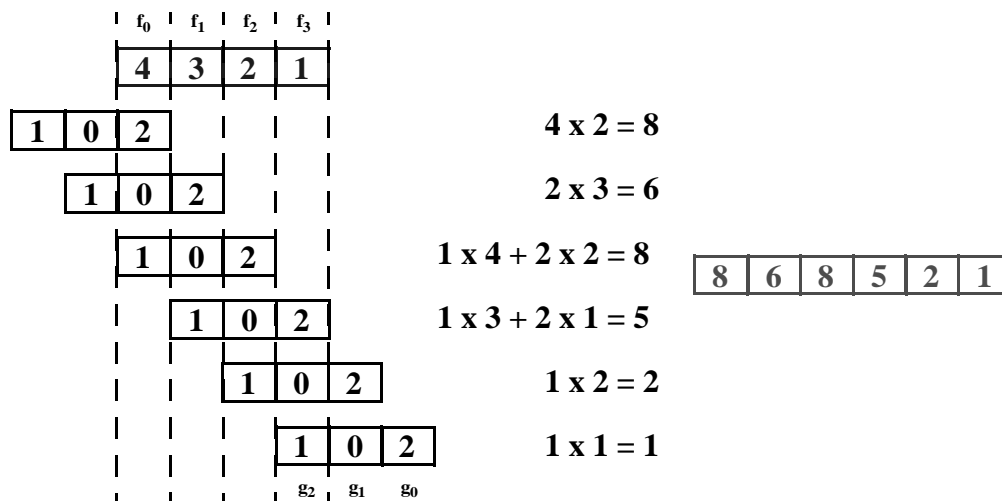

Example of a convolution

13.2 Cross-correlation

The cross-correlation function is a measure of the similarity between two data sets. One dataset is displaced varying amounts relative to the other and corresponding values of the two sets are multiplied together and the products summed to give the value of cross-correlation.

Mathematisch the cross-correlation is defined as:

$$\phi_{xy}(\tau) = \sum_i x_{i+\tau} \cdot y_i$$

where x_i : ($i=0 \dots n$); y_i : ($i=0 \dots n$); $\phi_{xy}(\tau)$: ($-m < \tau < +m$) with $m = \max.$ displacements.

Similar to the convolution, the cross-correlation can also be performed in the Fourier domain.:
Cross-correlation = Multiplication of Amplitudes and Subtraction of Phase spectrum.

Auto-correlation

The Auto-correlation is a Cross-correlation of a function with itself. It is mathematically defined as:

$$\phi_{xx}(\tau) = \sum_i x_{i+\tau} \cdot x_i$$

where $x_i = (i=0 \dots n)$; $\phi_{xx}(\tau) = (-m < \tau < +m)$ and $m = \max.$ displacement.

To make the cross-correlation and auto-correlation of different traces comparable they are normalised as follows:

Auto-correlation $\phi_{xx}(\tau)_{\text{norm}} = \frac{\phi_{xx}(\tau)}{\phi_{xx}(0)}$

Cross-correlation $\phi_{xy}(\tau)_{\text{norm}} = \frac{\phi_{xy}(\tau)}{\sqrt{\phi_{xx}(0)\phi_{yy}(0)}}$

13.3 Deconvolution

The aim of Deconvolution is the reverse of convolution in such a way that the reflectivity function is reconstructed. In practice one obtains not the real reflectivity function, but it results in

- a shortening of the Signals
- Suppression of Noise
- Suppression of Multiples.

:

$$\boxed{\mathbf{g}_t = \mathbf{w}_t * \mathbf{e}_t} \quad \longrightarrow \quad \boxed{\mathbf{e}_t = \mathbf{g}_t * \mathbf{w}_t^{-1}}$$

=> **Inverse Filtering**

However, in general the Function w_t is not known. Because of that it is not easy to obtain the inverse function w_t^{-1} .

To obtain a good approximation one can use a so-called “Optimum-Filter” or Wienerfilter.

An option is to reconstruct the waveform w_t using the Autocorrelation function. The auto-correlation function contains all the frequency information of the original waveform, but none of the

phase information. The necessary phase information comes from the minimum-phase assumption.

$$\begin{array}{ccc} \mathbf{Input-Function} & * & \mathbf{Filter} = \mathbf{Output-Function} \\ \mathbf{(known)} & & \mathbf{(wanted)} \quad \quad \mathbf{(known)} \end{array}$$

Another option is to determine a Filter operator, that from the signal the wanted Signal produces (e.g. a Spike, a Minimum Phase wavelet etc.). This is called the Wiener filter or least-squares filter.

This results in a system of equations:

$$\begin{bmatrix} g_0 \\ g_1 \\ \dots \end{bmatrix} \times \begin{bmatrix} f_0 \\ f_1 \\ \dots \end{bmatrix} = \begin{bmatrix} g_0 f_0 = y_0 \\ g_1 f_0 + g_0 f_1 = y_1 \\ \dots \end{bmatrix}$$

Solving this system of equations yields the appropriate filter operator f .

According to the aim there are different types of deconvolution:

- (1) Spiking Deconvolution: desired output function is a spike (also whitening deconvolution)
- (2) Predictive Deconvolution: attempts to remove the effect of multiples

*

14. Velocity analysis and NMO-Correction

Until now we have only discussed data processing method that improve the signal of each separate trace. Now different traces are summed, also called stacked, to improve the signal-to-noise ratio and to decrease the amount of data which will be processed to obtain an image of the subsurface. Before the stacking, a certain correction is applied on the different traces by carrying out a velocity analysis.

A good velocity model is the basis for :

- Stacking (Improvement of S/N-Ratio)
- Appropriate conversion from traveltime into depth
- Geometrical Correction (Migration)

14.1 Normal-Moveout (NMO) Correction

Principle:

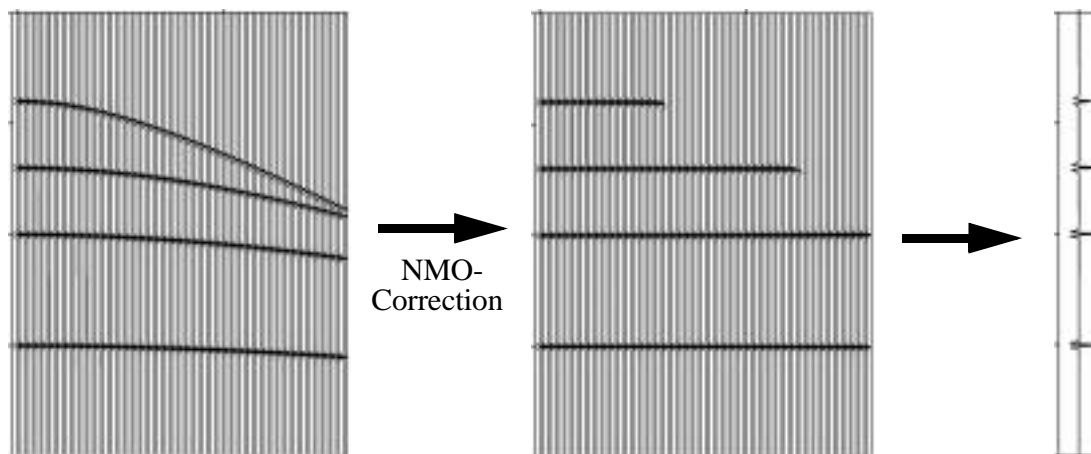

Reflectionhyperbolas

horizontal Alignment

Stacking

Principle of NMO-Correction. The Reflections are aligned using the correct velocity, such that the events are horizontally. Then all the separate traces are stacked (summed).

The traveltime curve of the reflections for different offset between source and receiver is calculated using:

$$t^2 = t_0^2 + \frac{x^2}{v_{\text{stack}}^2}$$

From this formula the NMO-correction can be derived and is given by:

$$\Delta t = t_0 - t(x) \quad \text{with} \quad t(x) = \sqrt{t_0^2 + \frac{x^2}{v_{\text{stack}}^2}}$$

The Moveout Δt is the difference in traveltime for a receiver at a distance x from the source and the traveltime t_0 for **zero-offset** distance.

The NMO-Correction depends on the offset and the velocity. In contrast to the static correction, the correction along the trace can differ. The NMO-correction is also called a **dynamic correction**.

To obtain a flattening of the reflections, the velocity must have the correct value. When the velocity is too low, the reflection is **overcorrected**; the reflection curves upwards. When the velocity is too high, the reflection is **undercorrected**; the reflection curve curves downwards.

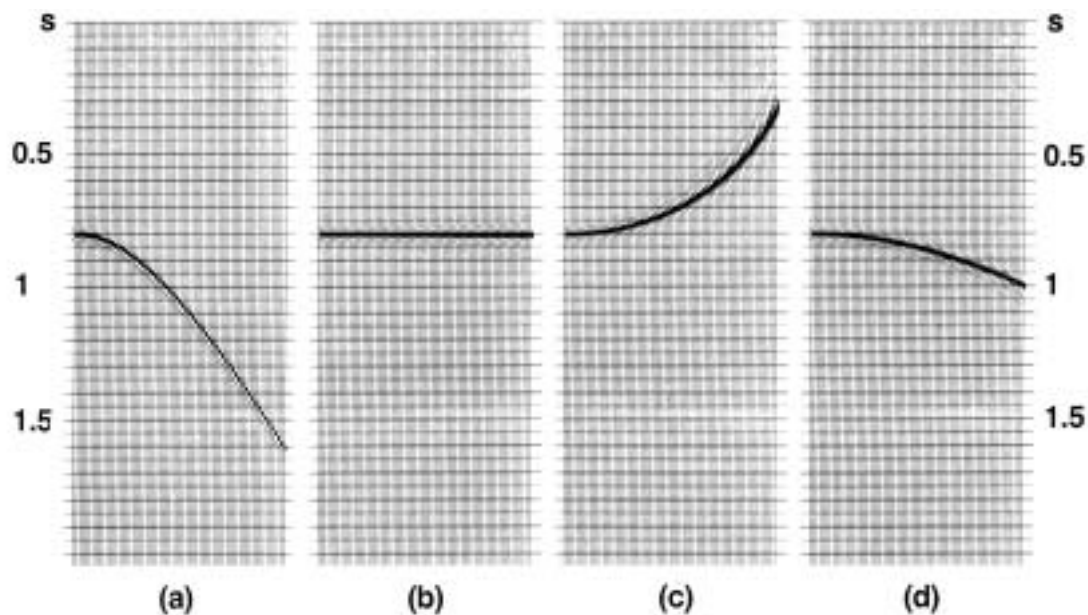

NMO-Correction of a Reflection. (a) Reflection is not corrected; (b) with proper Velocity; (c) Velocity is too low; (d) Velocity is too high.

Remark:

Low velocities have a stronger curvature than high velocities.

14.2 Methods for Velocity analysis.

The aim of the velocity analysis is to find the velocity, that flattens a reflection hyperbola, which returns the best result when stacking is applied. This velocity is not always the real RMS velocity. Therefore, a distinction is made between:

- v_{stack} : the velocity that returns the best stacking result.
- v_{rms} : the actual RMS-velocity of a layer.

For a horizontal layer, both velocities are equal. When the reflectors are dipping then v_{stack} is not equal to the actual velocity, but the velocity that results in a similar reflection hyperbola.

There are different ways to determine the velocity:

- (t^2-x^2) -Analysis.
- Constant velocity panels (CVP).
- Constant velocity stacks (CVS).
- Analysis of velocity spectra.

For all methods, selected CMP gathers are used.

(t^2-x^2) -Analysis

The (t^2-x^2) -Analysis is based on the fact, that the Moveout-expression for the square of t and x result in a linear event. When different values for x and t are plotted, the slope can be used to determine v^2 , the square root returns the proper velocity.

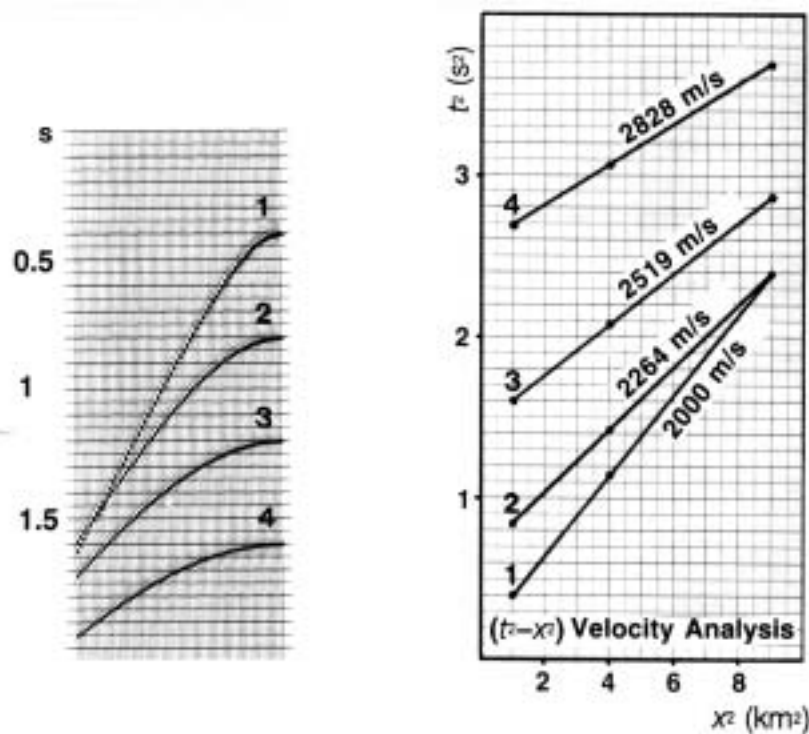

Example of a t^2 - x^2 -Analysis.

CVP - “Constant velocity panels”

The NMO-correction is applied for a CMP using different constant velocities. The results of the different velocities are compared and the velocity that results in a flattening of the hyperbolas is the velocity for a certain reflector. .

CVS - “Constant velocity stacks”

Similar to the CVP-method the data is NMO-corrected. This is carried out for several CMP gathers and the NMO-corrected data is stacked and displayed as a panel for each different stacking velocity. Stacking velocities are picked directly from the constant velocity stack panel by choosing the velocity that yields the best stack response at a selected event.

CVP and CVS both have the disadvantage that the velocity is approximated as good as the distance between two test velocities. Both methods can be used for quality control and for analysis of noisy data.

Velocity-Spectrum

The velocity spectrum is obtained when the stacking results for a range of velocities are plotted in a panel for each velocity side by side on a plane of velocity versus two-way travel-time. This can be plotted as traces or as iso-amplitudes. This method is commonly used by interactive software to determine the velocities.

Different possible methods can be used to determine a velocity spectrum:

- amplitude of stacking
- normalised Amplitude of stacking
- Semblance

•

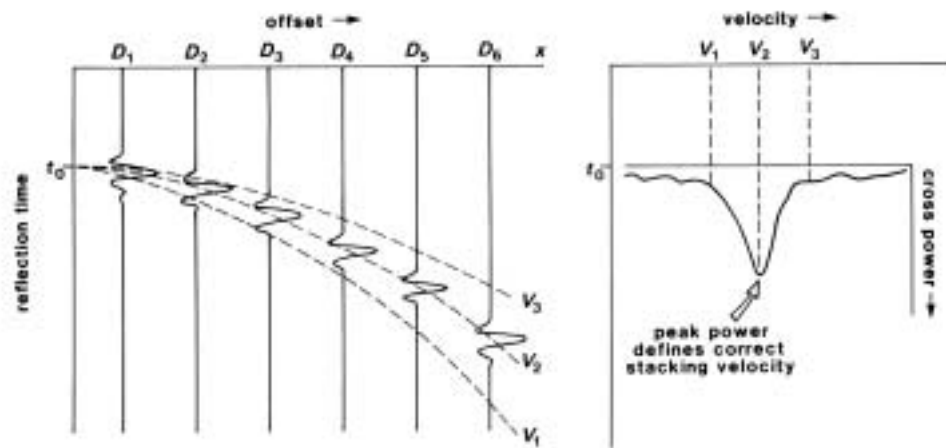

Amplitude of Stacking

$$s_t = \sum_{i=1}^n w_{i,t}$$

where n =number of NMO corrected traces in the CMP gather; w =amplitude value on the i -th trace at twoway time t .

Normalised Amplitude of stacking

$$ns_t = \frac{|s_t|}{\sum_{i=1}^n |w_{i,t}|}$$

Semblance

$$\text{Semblance} = \frac{1}{n} \cdot \frac{\sum_t s_t^2}{\sum_t \sum_i w_{i,t}^2}$$

Semblance-Calculations are only used for velocity analysis, because it returns always a value between 0 and 1.

14.3 Problem of “Stretching” of the data caused by NMO correction

NMO is a dynamic correction, that means that the values of a single trace are shifted with different amounts. This results for larger offsets in a stretching of the data and an artificial increase of the wavelength occurs.

This effect is relatively large for horizontal reflections with low velocities. To reduce the effect of the stretching on the result of the stacking procedure, the part with severe stretching of the data is muted from the data (“stretch-mute”).

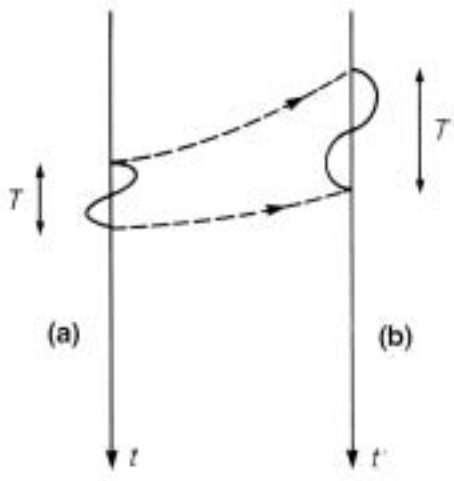

Dynamic correction results in a stretching of the data, which results in a artificial increase of the wavelength.

14.4 Factors affecting velocity estimates

The accuracy of the velocity analysis is affected by different factors:

- Depth of the Reflectors
- Moveout of the Reflection
- Spread length
- Bandwidth of the data
- S/N-Ratio
- Static Corrections
- Dip of the Reflector
- Number of traces

By a combination of CMP's that lie close together (Super gather), the accuracy is increased when a small number of traces per CMP are available (low coverage).

Errors due to dipping layers and insufficient static corrections can be reduced (DMO and Reststatics, are discussed later on).

15. Stacking

Stacking is performed by summation of the NMO-corrected data. The result is an approximation of a zero-offset section, where the reflections come from below the CMP position. (For a dipping layer, the reflections do not exactly come from below the CMP.)

15.1 Muting

Sometimes, the data contains still noise signals, that influence the stacking.

Gelegentlich enthalten die Daten auch nach der Bearbeitung noch Störsignale, welche die Stapelung beeinflussen. These traces are muted before the stacking.

Typical Noise signals are:

- Refractions (first breaks)
- Surface waves
- Air wave

Three possible muting procedures can be carried out:

- top mute: A certain timewindow in the beginning of the trace is muted (first breaks)
- bottom mute: A certain timewindow in the end of the trace is muted (surface waves)
- surgical mute: A time window in the middle of the trace is muted (air wave)

15.2 Methods of Stacking

Several methods can be used to combine the different NMO-corrected traces. The most important are:

Mean stack

All NMO-corrected traces are summed and divided by the number of traces:

$$s_{t, \text{mean}} = \frac{1}{n} \cdot \sum_{i=1}^n w_{i,t}$$

Weighted stack

In certain situations, unequal weighting of the traces in a gather may yield results that are better than the CMP stack. For example when certain traces contain a lot of noise. This type of stacking is often used to suppress multiples by weighting the large-offset data more heavily than the short-offset traces, because the difference in NMO between primaries and multiples is larger for larger offsets. A weight factor α is introduced.

$$s_{t, \text{meanweighted}} = \frac{1}{n} \cdot \sum_{i=1}^n \alpha_i w_{i,t}$$

Diversity stacking / Min-Max-exclude

Certain traces are muted and not included in the stacking procedure.

- When certain values differ too much from the average value they can be muted (diversity stacking). This to reduce the influence of spikes
- Exclusion of traces with the minimum and maximum amplitudes in the stacking procedure (min-max-exclusion or alpha-trimmed stack).

16. Special Filters

In the preceding chapters the most important processing steps for reflection seismics are discussed. Several other special filters and methods can be used to enhance the signals and to suppress noise. Two commonly used filter techniques are:

- f-k filter
- τ -p filter

Both filters use more traces at once. e.g. a whole common shot gather (CSG) or CMP (two- or three-dimensional transformations). The filters discussed before (deconvolution, frequency filter etc.) are applied on separate channels (one-dimensional transformation)

16.1 f-k filter

Most of the time, it is difficult to separate the reflections from noise. This separation can be made easier when the data is not processed in space-time domain, but transformed into another **domain**.

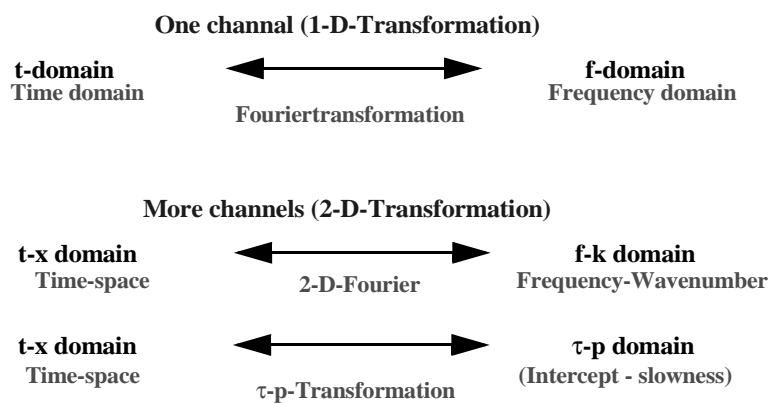

What is f-k?

The f-k transformation is in principle a two-dimensional Fourier transformation. Corresponding to the transformation of the time-axis to the frequency domain, the x-axis is transformed to the wavenumber domain. The frequency indicates the number of oscillations per second. The **Wavenumber k** indicates the number of wavelengths per meter along the horizontal axis (Some authors define k as the number of wavelengths per meter along the horizontal axis times 2π). For waves which propagate horizontally, the transformation returns the actual wavenumber. For waves that do not propagate horizontally, the horizontal component of the wave is transformed. An apparent wavelength and an apparent velocity is obtained:

$$v_a = \frac{v}{\sin \alpha}$$

$$\lambda_a = \frac{\lambda}{\sin \alpha}$$

with α =angle of the wavefront with the interface (or the angle of the ray with the vertical).

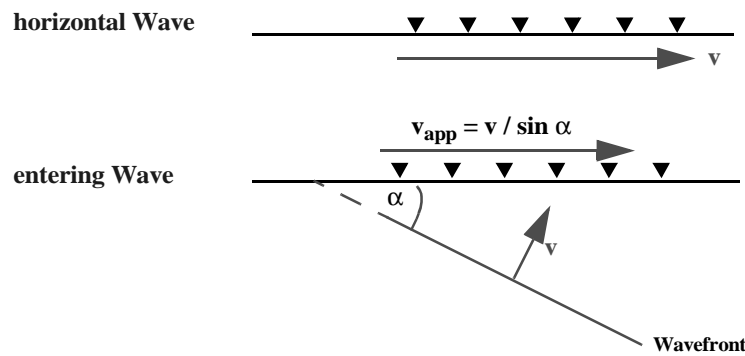

(Reflections that travel vertically, reach the geophones at the same time and therefore have an infinite apparent velocity.

The relation between the frequency and the wavenumber is given by: $f = v_a k$, i.e. the slope of a line in f - k domain is the apparent velocity v_a .

f-k spectrum

The plotting of a dataset in f - k domain is called a f - k spectrum. (Analogous to the frequency spectrum for the one-dimensional transformation from time to frequency).

The signals are separated and plotted as function of the frequency and slope (apparent velocity)

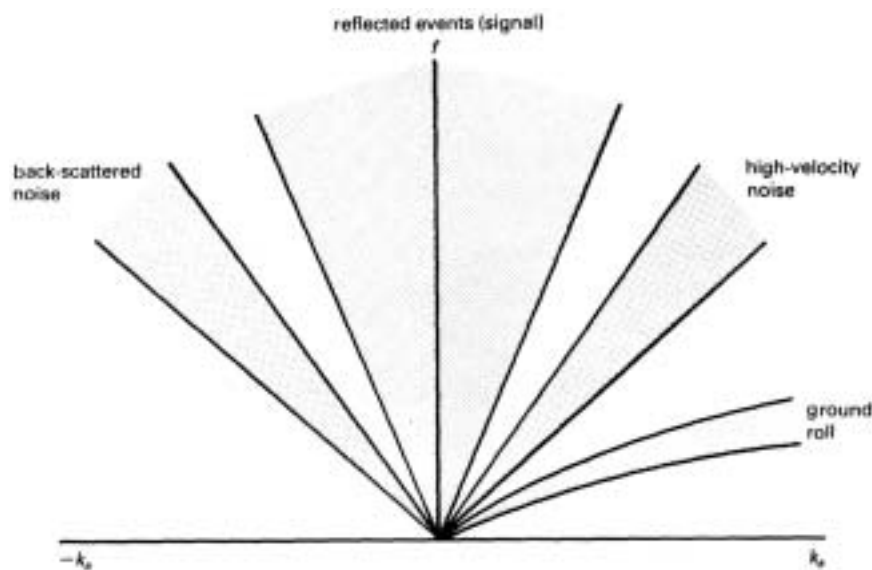

Negative wavenumbers indicate a slope in the other direction.

Applications of the f-k filter

Using the fk -transformation it is possible to mute a certain part of the f - k spectrum (for example the part that contains the interface waves). When the data is transformed back to the t - x domain, the interface waves are removed from the original data.

The spectrum that is muted is often defined as a certain fan in which the slopes or velocities are muted. (Such Filters are called "fan-filter", "pie-filter", "dip-filter", Velocity filter or Moveout-Filter)

Typical Applications:

- Suppression of noise signals with specific slopes (Interface waves)
- Suppression of multiple reflections
- Elimination of Artefacts in stacked Sections (post-stack)

Problem of spatial Aliasing

Aliasing in time domain occurs when the sampling rate of the signal is not high enough. A similar aliasing effect can occur when the apparent wavelength is smaller than twice the distance between the geophones. The spatial Nyquist-criterion is given by:

$$k_N = \frac{1}{2\Delta x}$$

where Δx =distance between Geophones.

(k_N depends on the apparent velocity and the frequency of the signal)

Spatial Aliasing can be observed in the f-k spectrum when events that are present for positive wavenumber continue on the other side of the spectrum for negative wavenumber values.

This effect is called “**wrap-around**”.

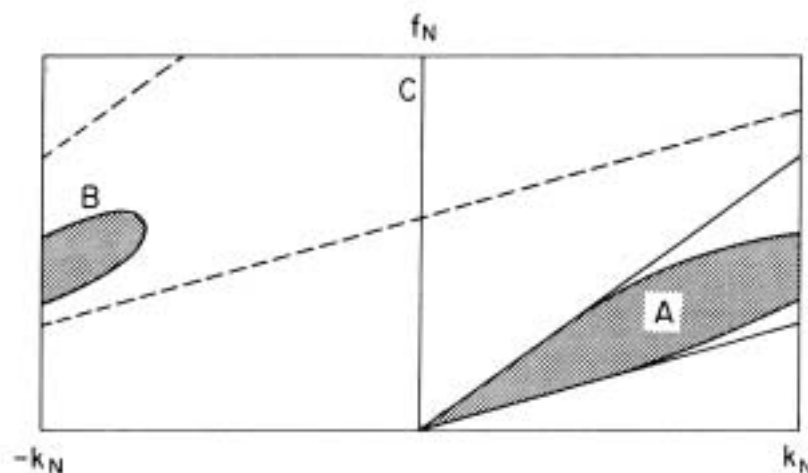

The Signal in shaded area A continue for wavenumbers larger than k_N . The Aliasing occurs when the data for wavenumbers larger than k_N appear in the spectrum as area B.

Note that:

Similar to the ringing effects that occur when a frequency filter is used with wrong parameters artefacts can also appear in the data when f-k filtering is applied.

16.2 τ -p-filter

An other filter that is often used is the τ -p filter (also called tau-p filter, Radonfilter or Slant-Stack). This filter transforms the data from (t-x) into a domain of Intercept-time τ (t_0 -time) and Slowness p ($p \sim 1/v$). The relation between t-x and τ -p is given by

$$\tau = t_0 - px$$

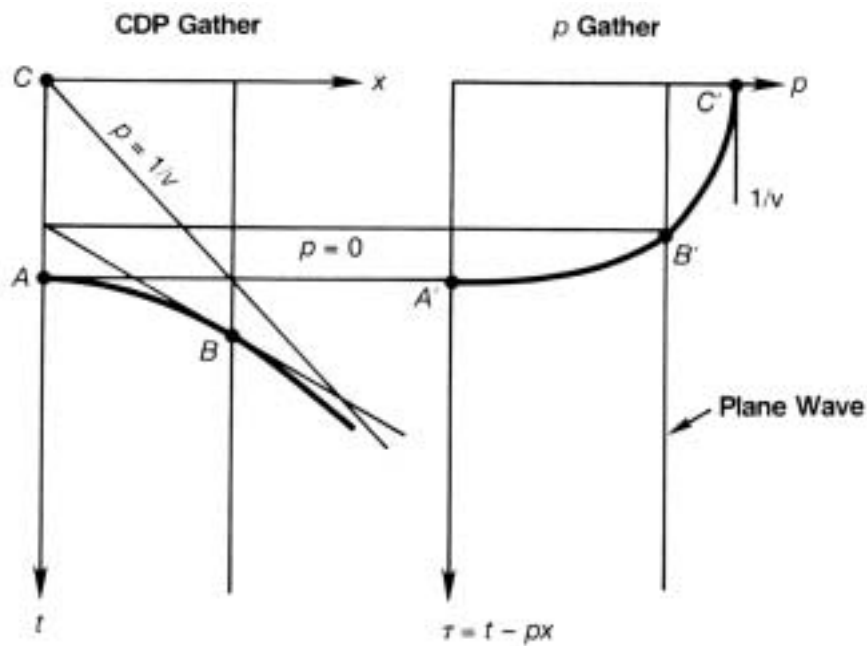

Each p -value indicates a certain slope in t - x -domain. The energy along a line is summed. The point of intersection with the t -axis ($x=0$) gives the intercept-time τ . In this way lines in t - x domain become a point in τ - p -domain and reflections become ellipses.

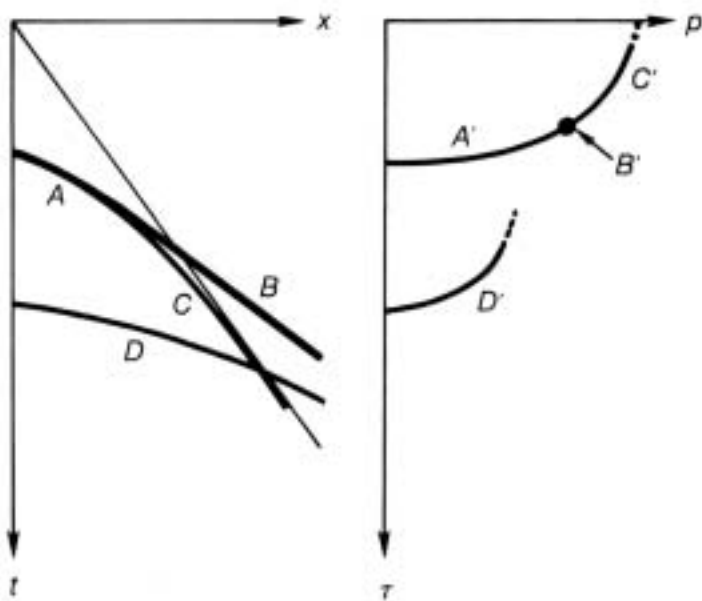

Different Elements in t - x -domain and the corresponding elements in τ - p -domain:
A, C: part of a reflection;
B: line;
D: Reflection.

Typical applications of the tau-p Filter

- Velocity filter
- Time-dependent velocity filter
- Suppression of multiples
- Interpolation between traces
- Analysis of Guided Waves

17. Residual static

In an early stage the general static corrections were discussed. Especially, the correction for the topography and the influence of the weathered layer were discussed. The aim of the static corrections is to shift individual traces in such a way that the reflections in a common midpoint gather lie as accurate as possible along a hyperbola.

Topographic corrections and refraction statics solve this problem only for a certain part. Most of the times small shifts between traces remain. To correct for these small shifts the residual static correction is applied.

17.1 Principle of Residual statics

The process of residual statics consists of shifting the separate traces in such a way that the optimal reflections are obtained. To make sure that the traces of a single CMP are not shifted randomly, the shift is divided in a value for the source (“source static”) and a value for the receiver (“receiver static”). For each source and receiver a value is determined. All traces with a certain source are corrected with the value for that source. Similarly all traces with a certain receiver are corrected with the value for that receiver.

The resulting shift (static correction) of a trace consists of the correction value of the source and receiver of the corresponding trace.

This processing still assumes that the static shifts are caused by the interface. Therefore, this processing is also called **surface consistent static correction**.

Scheme of residual static corrections

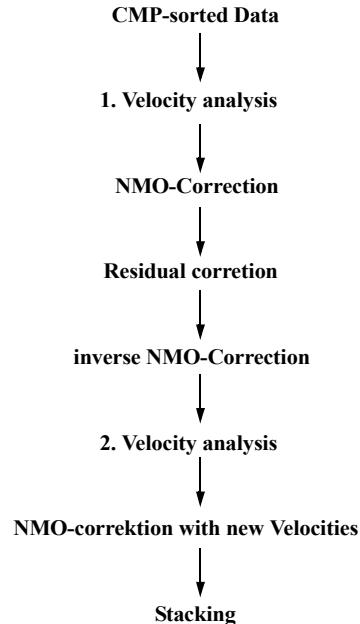

18. Migration

Stacking returns the first image of the subsurface. However, for a complex geometry and dipping reflectors, this image does not resemble with the reality. For example, the stacked data can still contain diffraction hyperbolas. The process that corrects for these effects is called **Migration** (also called “imaging”).

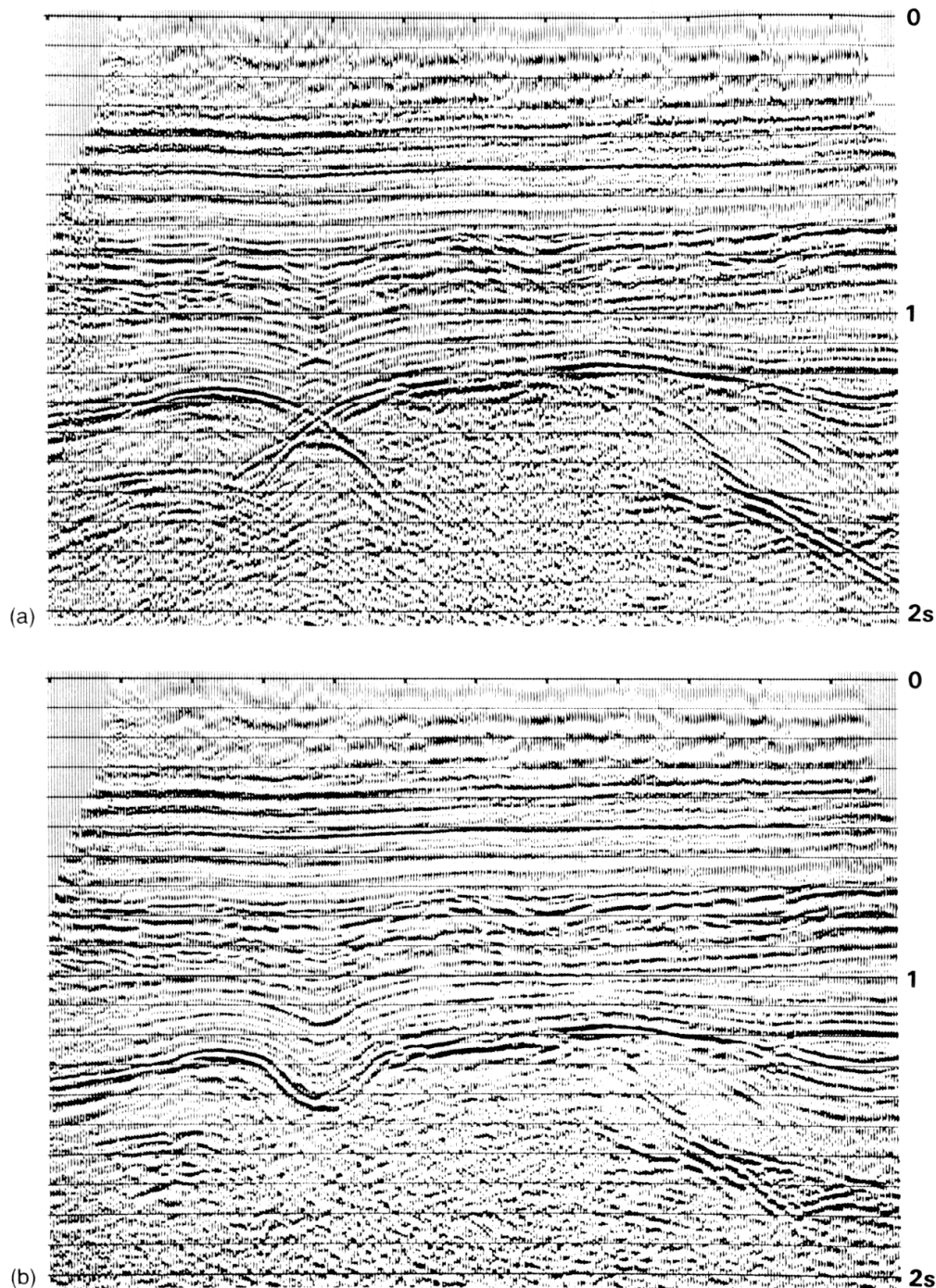

Example of a seismic Section. (a) Stacking without Migration. (b) with Migration.

18.1 Geometrical Distortion

Zero-offset traces are generated by NMO correction followed by stacking. (All following processing steps assume Zero-Offset-Data). The Data are plotted as if the reflection point is present directly below the CMP. In reality, the reflection for a zero-offset measurement is incident perpendicular on the layer. When a layer is horizontal, both facts are true. However, when a dipping reflector is present, the point of reflection is present besides the point directly below the CMP. All possible reflection points lie on a semi-circle that has a radius that depends on the travelttime.

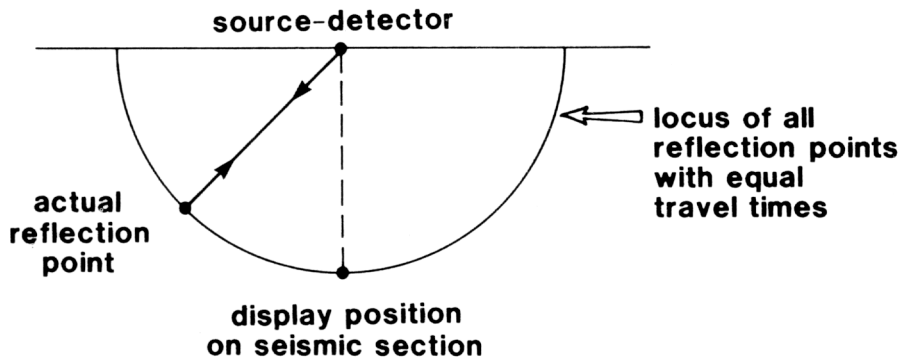

Positions of all possible reflection points with equal travelttime.

Typical Structures, that cause geometrical distortion, are:

- Dipping Reflector
- Valley
- Point reflector

Dipping Reflector

For a zero-offset measurement, the reflections coming from a dipping reflector travel perpendicular to the dipping interface. However, they are plotted in a stacked section as if they have travelled perpendicular to the surface. This is why the image of a dipping reflector obtains a wrong dip in the stacked section.

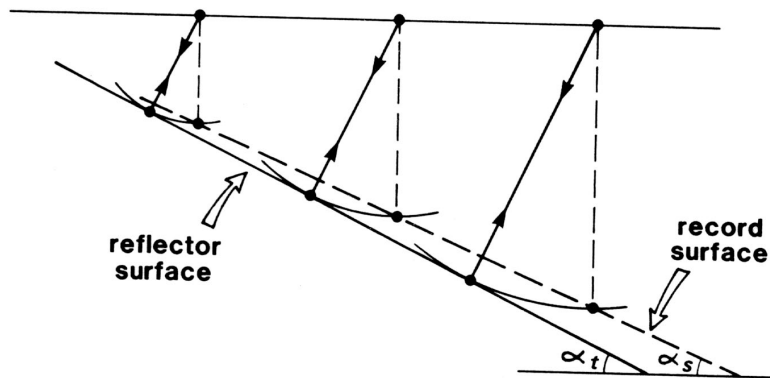

The difference between the real dip and the dip in the stacked section is given by:

$$\sin \alpha_{\text{real}} = \tan \alpha_{\text{Stapelung}}$$

A perpendicular reflector will be plotted with a dip of 45° abgebildet. This shows that the **maximum dip of Reflections in a Stack is 45°** . Larger dips are thus due to noise signals or other effects.

Syncline

Another effect that occurs often in stacked data is for example a syncline, a valley in stratified rocks in which the rocks dip toward a central depression.

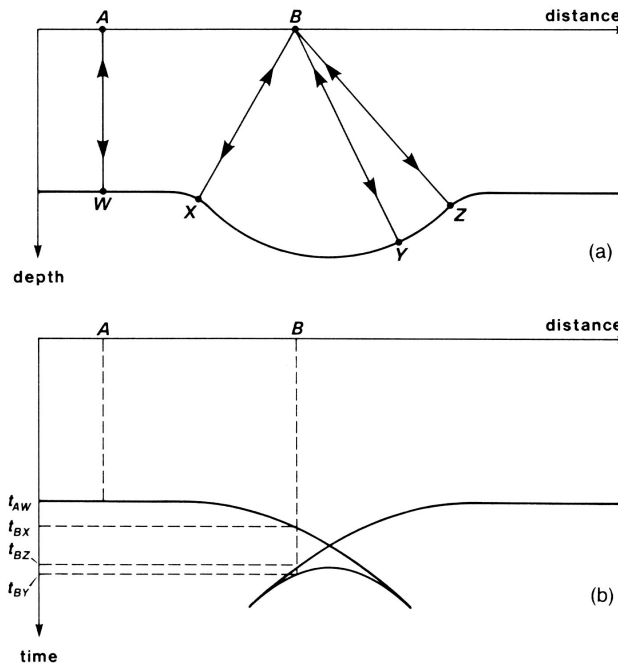

As shown in the figure, there are different rays coming from position B that are perpendicular to the reflector and thus are measured by a zero-offset measurement. The different reflections have different traveltimes, so in stead of only one reflection, three reflections are measured at position B and thus three reflections are plotted at position B. In a stacked section, the syncline is not directly distinguishable. In stead, we see a “**bow-tie**”.

Point reflector

Point reflectors appear in a stacked section as a diffraction hyperbola. This hyperbola becomes visible, because all rays from all directions are perpendicular to this point reflector and will result in a reflection. The traveltime increases with increasing distance. The travel time curve that results is a hyperbola (**Diffraction hyperbola**).

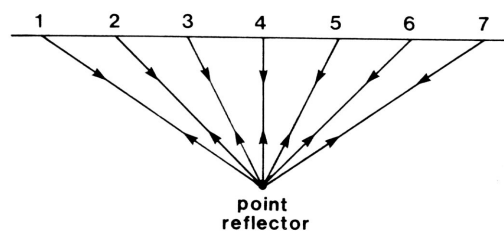

Diffraction hyperbolas also appear at edges.

18.2 Methods for Migration

Migration is a proces that reconstructs a seismic session so that reflection events are repositioned under their correct surface location and at a corrected vertical reflection time.

The following effects is corrected for:

- point diffractions are collapsed to one point
- Location and dip of layers are adjusted
- Improvement of the resolution by focusing of the energy

Basic Corrections

The real angle of a dipping reflector can be obtained by using the equation given earlier. However, the actual position of the dipping layer is not obtained.

A simple graphical reconstruction using arcs can be performed to migrate the data.

One draws a semicircle with the radius of the travel time through a reflection point. The real position lies somewhere on this circle. When different semicircles are drawn for different points on a dipping reflector, then the real position of the dipping layer can be obtained by the tangent of these circles.

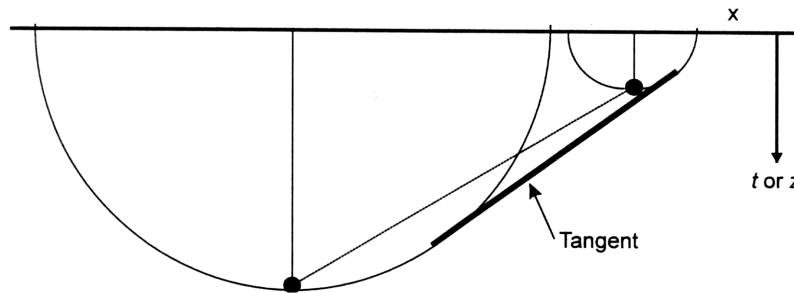

Point diffractions can be reconstructed similarly. They are present at the apex of the diffraction hyperbola and can be obtained by the different arcs that are drawn with the radius of the travel time from different points on the hyperbola.

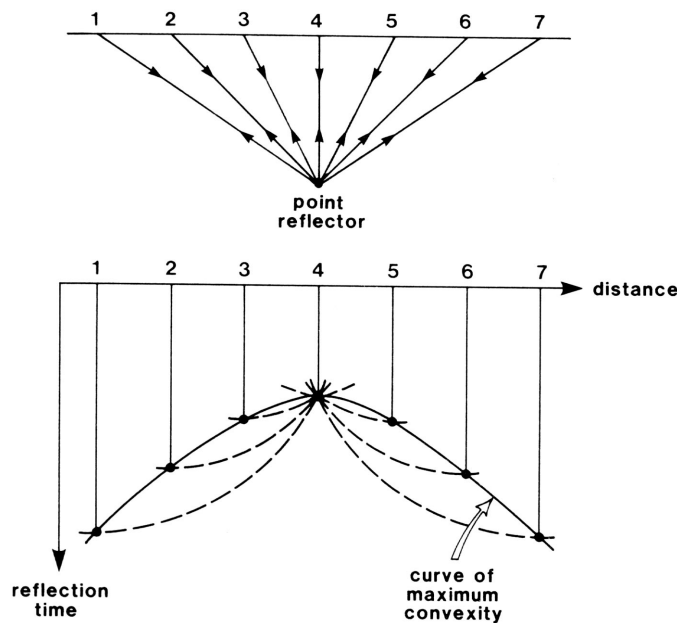

Methods for Migration

There are different ways to migrate seismic data:

- “wavefront charting”
This is in principle the method discussed before.
- Diffraction-Migration (**Kirchhoff-Migration**)
All energie is added along diffraction hyperbolas.
- **Fk-migration**
Correktion for slopes in the Fk-domain
- Downwards continuation
Operation that corrects for the propagation of the wave fronts.
(e.g. **phase shift migration**)
- wave-equation migration(**FD-Migration**)
Correction for the travelttime by solving the wave equation

The different methods have also different properties and differ in:

- Accuracy and type of und type of the required velocity model.
- Vertical velocity change can be taken into account
- Lateral velocity change can be taken into account
- Correction of dip
- Calculation time

Velocity model for Migration

Some methods only use one velocity for the whole dataset, whereas other methods can use a complex velocity model with vertical and lateral velocity changes.

In general one can say:

A complex structure in the subsurface requires a more complicated velocity model.

For a starting model, often the model is used that is employed for the stacking. However, most of the time adaption are needed (The migration velocity for deeper layers is often between 90% and 80% of the stacking velocity).

When the chosen velocity is too small, the diffractions are not fully collapsed into one point. The data is **undermigrated**. When the chosen velocity is too high, then arc appear above the diffraction point (“**Smile**”). The data is **overmigrated**.

Boundary effects

At the boundary of a seismic section arise often strong effects : half arcs or hyperbolas.

18.3 Special Migration and extension

3D Migration

Until now we only discussed two-dimensional data. In reality, the structures are not always directly beneath the profile. There are often reflections from structures that lie off-line from the seismic profile (“**side swipe**”). Reflections from such off-line structures can not migrated to their correct position by using 2D migration. To correct these structures correctly, the data must be processed and migrated in three-dimensions.

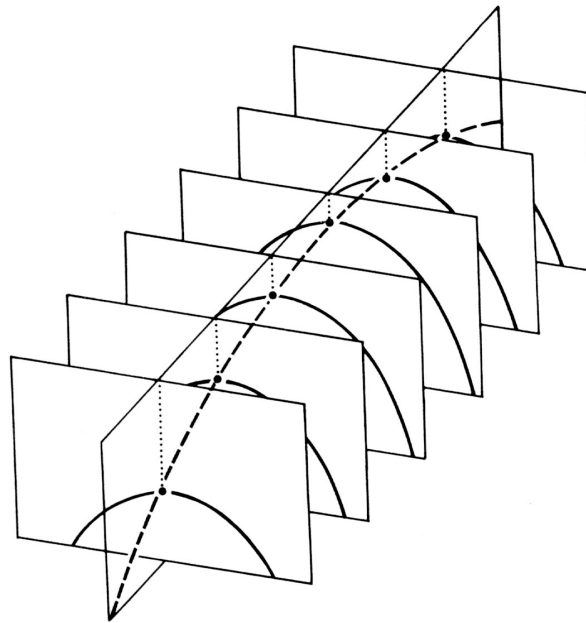

Depth migration

Until now the migration is treated mainly in time domain. However, one is also interested in the actual depth of a reflector. There are different possibilities to reach this goal:

- Change of stack in depth
- Change of migration in depth
- Depth migration

When a stacked section is converted then all geometrical distortions remain.

When a time migrated section is converted into depth then the timing of the reflections are converted into depth using the vertical velocity model.

However for complex structures and strong velocity contrasts distortions appear, because in reality the waves do not propagate only vertically. Different algorithms consider the travel path through a complex structure and transform directly the stacked sections into a depth section. The conversion from travel time into travel path is not carried out only vertically, but along the (correct) direction of the traveling waves. Depth migration converts a seismic time section into a depth section where the perpendicular travel time of each individual reflector is converted in depth using the “correct” velocity model. This is the most accurate way of migration, but requires also the most processing time.

“Dip Moveout Correction” (DMO-Correction)

(sometimes also called partial Prestack-Migration)

Until now we have assumed that the data was real zero-offset data, that is obtained by stacking of multi-offset data. It is mentioned several times that the NMO correction for strong dips does not result in the correct result. The traces of a CMP have a different reflection point and the apex of the reflection hyperbola is horizontally shifted. To correct for these effects additional processing is needed: DMO correction (“Dip Moveout”).

Prestack-Migration

One step further is to use all data which is available before the actual stacking is carried out. That means that all geometrical distortions are removed before the stacking.

=> Prestack-Migration

In principle the same correction is applied on the data as the use of DMO followed by Post-stack migration.

$$\text{DMO} + \text{Poststack-Migration} = \text{Prestack-Migration}$$

Poststack migration migrates all stacked CMP traces, whereas prestack migration migrates all traces of all shots. Because there are a lot more traces before the stacking compared with after, the prestack migration requires much more computing time.

19. Post processing

After successful stacking and migration, the data are often “post processed” for reproduction, e.g. interpretation purposes

Aim of post processing:

- Elimination of filter effects
- Eliminate effects that originate from stacking or migration
- Adjust Amplitudes for plotting purposes
- Improve coherency of Reflections

Frequently used operations in “Postprocessing”:

- Time dependent Frequency filter
- Deconvolution
- Coherency filter
- AGC

19.1 Time dependent frequency filter

Reason for filtering after Stacking:

- By using different filters additional noise is generated
- The frequency content of the data has changed due to different processing steps (e.g. NMO stretching)
- Time dependent frequency filter is often not used before the stacking procedure

Time dependent frequency filter consists of filter parameters that change with travel time. In this way, the absorption of high frequencies with increasing travel time can be adjusted for.

The filter parameters do not vary continuously, but the travel time is divided in different windows for which the different parameters are determined

19.2 Deconvolution

Sometimes, it is tried to improve the resolution of the data or to change the waveform to a predefined shape after stacking using deconvolution.

The deconvolution after stacking does not differ from the deconvolution before stacking. Parameters and the working of the operations are equal.

19.3 Coherency filter

After stacking or Migration, it is possible that the data are disturbed by noise and artefacts. Using special filters it is possible to improve the signal to noise ratio and the continuity of the reflections.

Often used filter methods are

- fk-Filter
- fx-dekonvolution (Wiener-Levingson Filter)
- Korhunen-Loeve Filter (Eigenvector-Filter)

All these Filters use several seismic traces in the calculation. (More channel-filter)

19.4 Adaption of Amplitudes

Depending on the aim of the interpretation or output, the reflections should be gained such that also weak reflections can be distinguished

When one is interested more in structures, then all reflections are amplified using an AGC gain with a small window. When the reflection characteristic, the difference in amplitude, should be preserved then an AGC gain with large window is used.

Adjustments of the amplitudes is also often needed when the data are plotted on a printer.

19.5 Archiving of Data

When all processing steps are carried out, the data is plotted or saved. This can be done by

- digital archiving and Visualisation on a computer screen
- Plotting on paper

Digital archiving

- Archiving on Magnetic tapes or CD-ROMs
- Data can be reproduced using different processing parameters or different time slices
- Interpretation on screen with an interactive program

Often the Data are archived in SEG-Y Format, which is generally used everywhere.

The data can be easily exchanged with other programs.

Printing on paper

- Safe archive
- Interpretation by hand (without expensive software-package)
- Improved view for long profiles

Components of a paper print:

Except for the data, also additional information should be mentioned on the paper print, such that everybody knows what processing was performed on the data. It is e.g. important whether the data is only stacked or also migrated. Such information is mentioned in the so-called “**sidelabel**”.

<u>Operator</u>		
Acquisition contractor	Processing contractor	Company logos
Line no.		Line identifier
SP's		Line SP range
4200%, DAS, DBS, TVF		Key processing stages
W ←		Shooting direction
Generalized index map	Generalised location map	Index map —shows survey area relative to other significant features
Shot by Date		
Processed by Date		
Contract no.		
<u>Recording data</u>		Lists recording parameters
		Diagrammatic representation of shooting and recording arrangement. Shows location of SP as marked on section
<u>Processing sequence</u>		List processing sequence in correct order
<u>Display parameters</u>		Includes statement of section polarity
<u>Legend</u>		Symbols use for section annotation
<u>Section scales</u>		Horizontal and vertical scales
(maximum 19 cm width—to allow for folding to A4)		

Example of a “Sidelabel” and its components.

It is common, additional to the information in the sidelabel, to show also the parameters that change along the profile. This information is then plotted above the data (“**Header Plots**”).

In the header plot different information can be given, e.g.:

- Velocity functions
- Fold
- Topography
- Point of intersection with other profiles
- Location of borehole loggings

20. Interpretation

In this lecture only a general overview of the interpretation of seismic data is given. Further information can be obtained for example from the course “Seismische Faziesanalyse”, that is usually given in the Summer semester.

One can distinguish different aims for the processing of the data:

- Mapping of geological Structures
- Seismostratigraphy
- Seismic Facies analyse
- Modeling

In addition there are special interpretation possibilities for 2D and 3D Data.

20.1 Mapping of geological Structures

For the mapping of geological structures in seismic data, the position of main horizons and disturbances are mapped and the form and position of faults are identified.

Aim:

- to obtain the geological profile
- to obtain depth charts of horizons and disturbances

Foregoing steps:

- “**Picking**” of the beginning of Reflections
- Determination of their travel time

When more seismic lines are available:

- Draw travel times in a map
- Generate isolines

For more crossing profiles, a horizon on a certain profile should be tracked to the other profiles to obtain a closed curve. In this way, one can check whether the same phase is correctly tracked or that one has followed a wrong reflection after a disturbance.

“Fence-Diagram”

Three-dimensional picture of crossing profiles

20.2 Seismic Sequence-Analysis (seismic sequence stratigraphy)

Aim

- Identification of sequences in seismic data
- Determine the sequence of the sedimentation in time
- Analyse sealevel fluctuations.

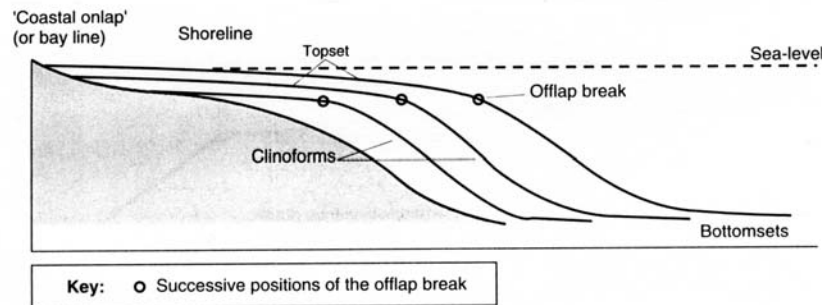

Sequence of a coast.

The fundamentals of sequence-stratigraphy were investigated in the 70” by a research group of the oil company Exxon. Different concepts were defined which are now standard to describe seismic data.

An elaborate description can be found in the articles from the Exxon-Group. Especially Mitchum, R. M., Jr. and P. R. Vail and S. Thompson, III (1977). *Seismic stratigraphy and global changes of sea level, part 2: The depositional sequence as a basic unit for stratigraphic analysis*. In: Payton (edt.), *Seismic stratigraphy - applications to hydrocarbon exploration*. Am. Assoc. Pet. Geol., Memoir, 26, Tulsa, Oklahoma, 53-62.

Vail, P. R. and R. M Mitchum, Jr. and R. G. Todd and J. M. Widmier and S. {Thompson, III} and J. B. Sangree and J. N. Bubb and W. G. Hatlelid (1977). *Seismic stratigraphy and global changes of sea level*. In: Payton (edt.), *Seismic stratigraphy - applications to hydrocarbon exploration*. Am. Assoc. Pet. Geol., Memoir, 26, Tulsa, Oklahoma, 149-212.

Sequences are on the upper- or/and lower part terminated by “**unconformities**” or concordancen. The figure below shows the most important types:

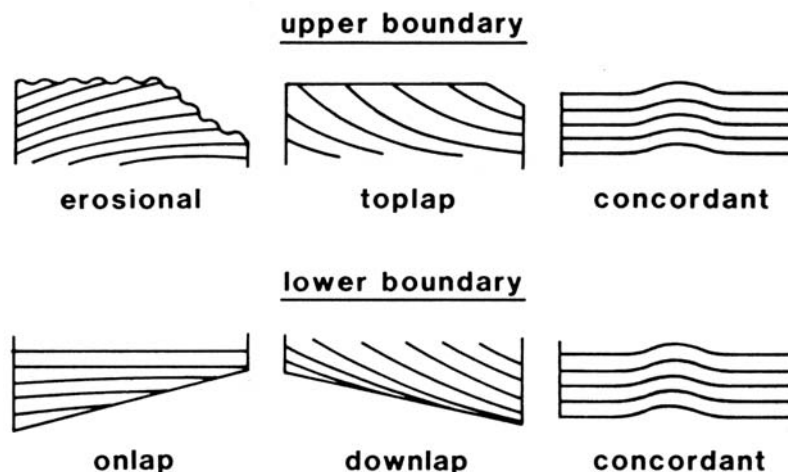

When different sequences can be identified in a seismic section, one can construct the time sequence of the sediment (**Chronostratigraphy**). One can then draw conclusions about the interpretations for different phases of relative rise or fall of the sealevel (**Transgression and Regression**).

20.3 Seismic Facies Analysis

(Only a short overview is given. More is discussed in the lecture of Gregor Eberli)

Additional to the boundaries of a seismic sequences, one can also investigate the reflection characteristics inside a sequence. Areas with similar reflection character correspond to a seismic facies. Not only the time sequence of the sedimentation can be obtained, but it is also possible that conclusions can be drawn about the sedimentation in the environment.

Similar to the boundaries of a sequence, there are different concepts, to describe the character of reflections.

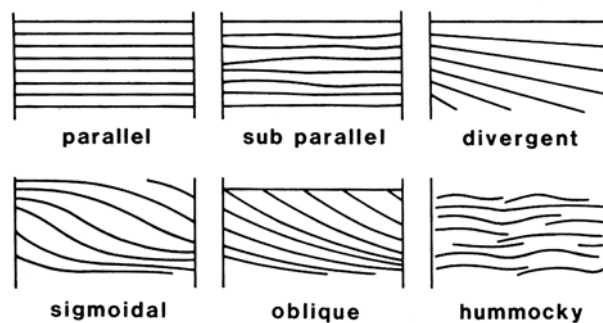

Geometry of reflections in a sequence (Selection).

Additional to the description of reflections in a sequence also different forms for seismic entities exist:

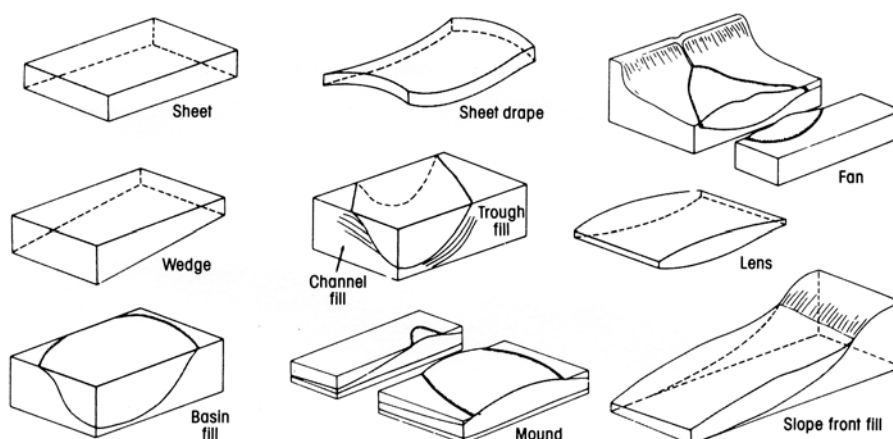

Possible Forms of seismic Entities.

20.4 Interpretation of 3D-data

For a three-dimensional interpretation we need three-dimensional data. Special systems are needed for a useful analysis and visualisation of 3D-Data.

Advantage of 3D-Interpretation

- Arbitrary slices through data is possible
- Horizontal time slices can be generated and interpreted
- Combination of different plotting methods
- Analysis of the actual dip and position of structures

Visualisation methods of three-dimensional Data

- Data-Cube
- Arbitrary slices
- Horizontal time slices
- “Chair”-Diagram

20.5 Other Aspects of interpretation

AVO - Amplitude variation with offset

Investigation of the angle-dependence of the reflections for different distances between the source and receiver. A variation in amplitude depends on the Poisson-ratio, density and the seismic velocity and can result in a conclusion concerning the oil and gas content.

One needs data with a high quality. Additionally, the data processing must be adapted such that the amplitudes are preserved

Attribute-Analysis

The common amplitudes are replaced by another parameter, e.g.:

- Instantaneous phase
- Instantaneous frequency
- Envelope

Using these attributes certain aspects of the data can show up more clearly.

Typical example for such an analysis is the emphasis and investigation of so-called “**bright spots**”. These bright spots have exceptional strong amplitudes, that are due to the high Impedance contrast of oil or gas with water.

Interpretation of “deep” reflections

In the processing of seismic Data from the deep Crust, one obtains in general no continuous reflections, but patterns with different reflectivities. In such cases the stark phases are often plotted as lines and interpreted.

21. Other related methods

Finally, some methods and concepts are discussed that are not discussed thoroughly in the lecture, but have to do with reflection seismics.

21.1 VSP - “vertical seismic profiling”

For a standard seismic measurement, the source and receiver are always present on the surface. However, it is also possible to carry out measurements where either the receiver or the source are present in a borehole (In general, the receiver is present in the bore hole).

One can distinguish:

- **zero-offset VSP:** The source is present at the surface close to the bore hole.
- **offset VSP:** The source has a certain distance from the bore hole.
- **walk-away VSP:** Measurements are carried out with different distances between the source and the bore hole .

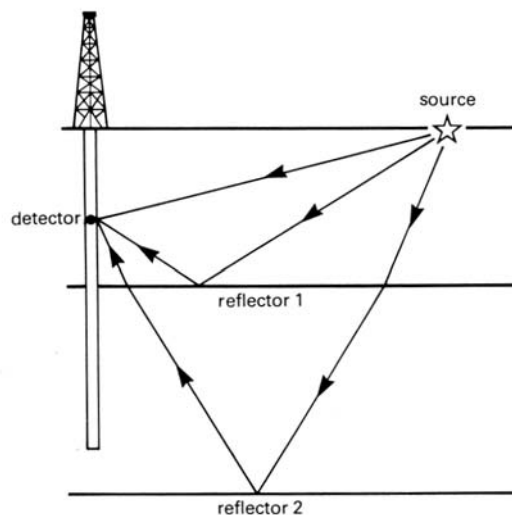

Typical offset VSP measurement.

In general, the VSP measurements are expensive (one needs a bore hole), but there are also certain advantages compared with the standard seismic measurement.

- Depth of the receiver is known
-> Improved velocity depth model.
- Smaller travel times
-> Improved resolution, less attenuation
- Improved separation between primaries and multiples
- Improved deconvolution due to the measurement of the direct wave.

In a VSP seismogram one can distinguish between upgoing and downgoing waves. The direct wave (downgoing wave) enables the determination of a velocity model. Reflections are upgoing waves.

A separation of up- and down-going waves is possible by using a fk-filter.

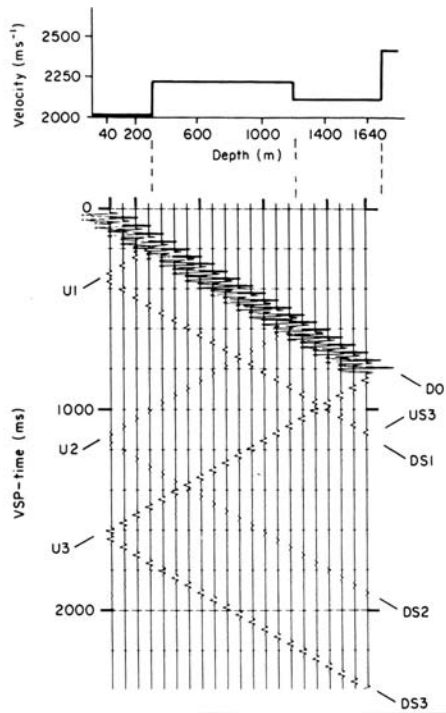

Synthetic Seismogram of a VSP-Measurement (Kearey and Brooks, 1991).

The reflections from the upgoing waves can also be aligned horizontally by shifting with the traveltimes of the direct wave. This data can then be stacked and a seismic trace is obtained that can be compared with a general surface recorded seismic trace.

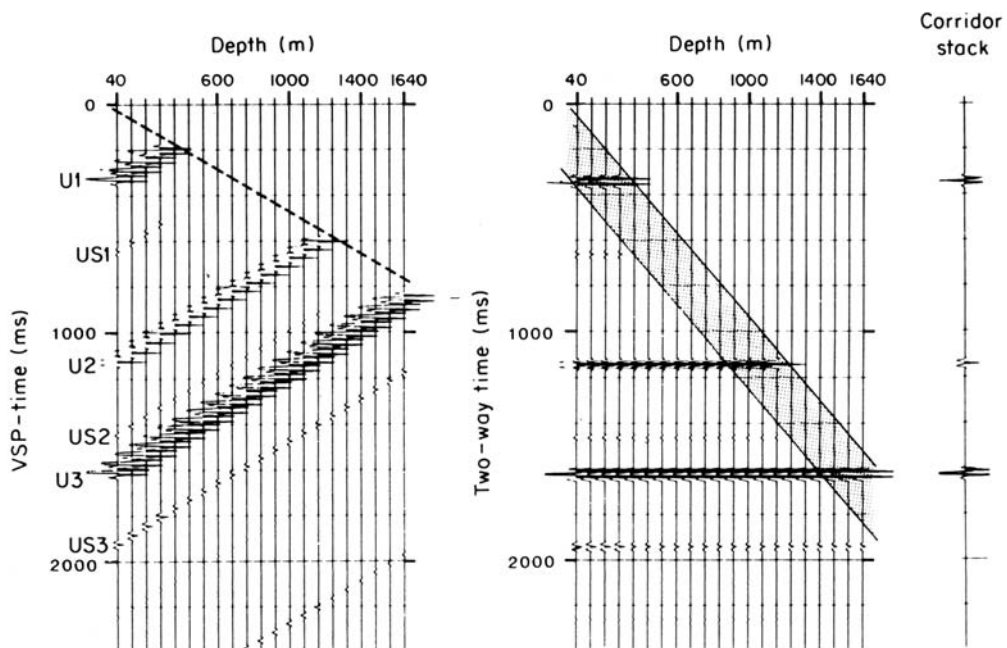

(a) Synthetic VSP section with downgoing waves removed by fk -filter; (b) Correction with the traveltimes of the direct wave ; (c) Stacked seismogram produced by stacking in the shaded dcorridor zone of (b) to avoid multiple events.

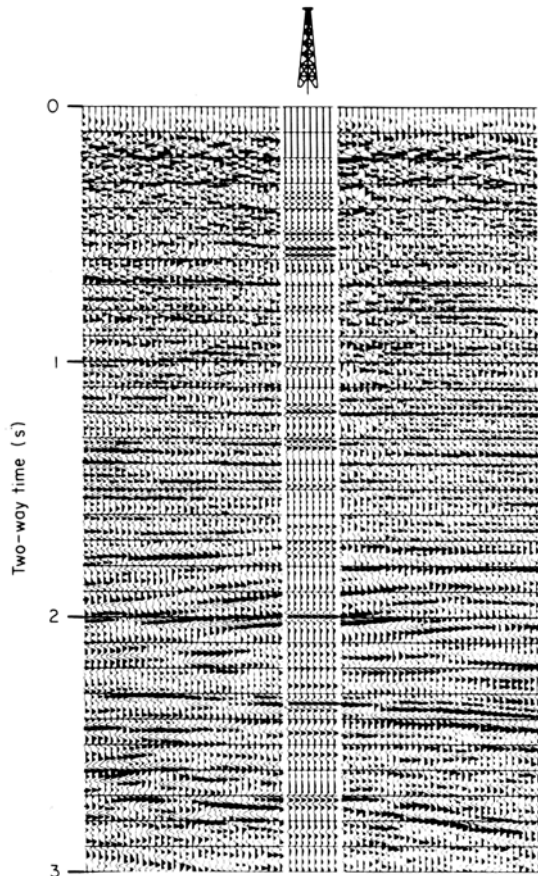

Comparison of the zero-offset VSP stacked section (last figure (c)) and a conventional seismic section based on surface profiling.

21.2 Cross-hole seismic

In stead of using only one borehole, also more boreholes for sources and receivers can be used. This method is called Cross-hole seismics.

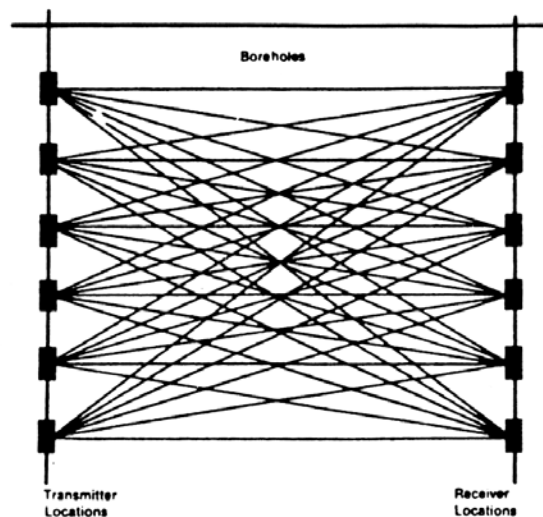

In general, only the travel time between different source-receiver combinations is used to obtain a velocity model of the subsurface between the boreholes (**Tomography**).

21.3 New developments

4D-Seismics

(time-lapse-seismics)

Repetition of 3-D seismics at a certain location at different times to analyse the changes in the subsurface. Is mainly used in the oil industry.

3-C Seismic (3-components Seismic)

Simultaneously measuring of x-, y- and z-components of the seismic wave fields.

4-C Seismic (4-components Seismic)

For marine measurements, regular 3-components geophones are placed together with a hydrophone on the bottom of the ocean.

Converted waves

Analysis and processing of P-S or S-P converted Waves, to obtain additional information of the subsurface.

21.4 Sidescan sonar

Acoustic measurement methods like the echosounder or Sidescan Sonar use a similar principle as reflection seismic. Both methods are used to investigate the bottom of the sea.

A sidescan sonar insonifies the sea floor to one or both sides of the survey vessel by beams of high frequency sound (30-110 kHz). Sea bed features facing towards the survey vessel, such as rock outcrops or sedimentary bedforms, reflect energy back towards the transducers while in the case of features facing away from the vessel, or a featureless sea floor, the acoustic energy is reflected away from the transducers.

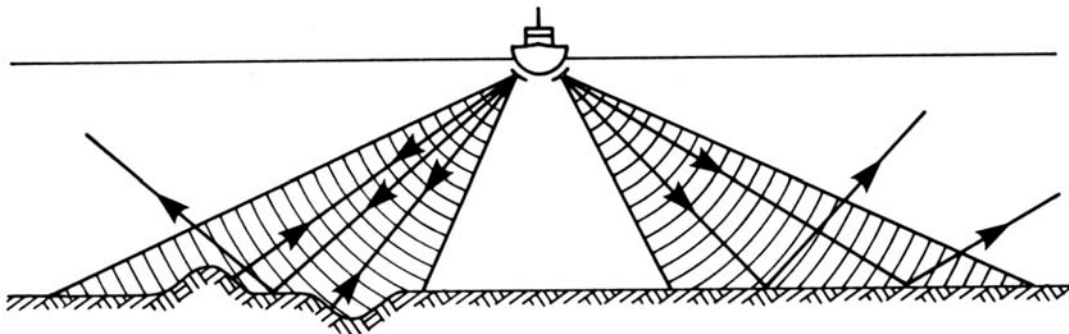

21.5 Georadar

The Georadar uses an electromagnetic signal instead of elastic waves. Often, only one source and one receiver are used with a common offset. A radargram contains reflections which are comparable with seismic results. The processing (filtering, amplitude correction, NMO and Migration) are similar.

22. Selection of used References (Figures etc.)

- Brouwer, J. and Helbig, K. (1998). Shallow high-resolution reflection seismics. Handbook of Geophysical Exploration, Volume 19. Elsevier Science, Amsterdam, 391 pp.
- Domenico, S.N. and Danbom, S.H., 1987. Shear-wave technology in petroleum exploration - past, current and future. In: Danbom, S.H. and Domenico, S.N. (eds.), Shear-wave exploration. Society of exploration geophysists, Tulsa, OK, USA.
- Emery, D. and Myers, K.J. (edt.) (1996). Sequence Stratigraphy. Blackwell Science, Oxford, UK, 297 pp.
- McQuillin, R., Bacon, M. and Barclay, W. (1984). An introduction to seismic introduction - Reflection seismic in Petroleum Exploration. Graham and Trotman, London, UK, 287 pp.
- Meissner, R and R. K. Bortfeld, 1990. DEKORP-Atlas. Springer-Verlag. Berlin.
- Sheriff, E.G. and Geldart, L.P.** (1995). Exploration Seismology, (2nd ed.). Cambridge University Press, Cambridge, 592 pp.
- Yilmaz, Ö.** (1987). Seismik data processing. SEG Tulsa, OK, 826 pp.
- Kearey, P. and Brooks, M.** (1991). An inrtoduction to geophysical prospecting. Blackwell Scientific Publications, Oxford, 254 pp.
- Reynolds, J.M. (1998). An introduction to applied and environmental geophysics. John Wiley and sons, Chichester, UK, 796 pp.
- Telford, W.M., Geldart, L.P. and Sheriff, R.E (1990). Applied Geophysics (2. ed.). Cambridge University Press, Cambridge, 770 pp.