

Reflection seismic 1 script

Educational Material

Author(s):

Kruk, Jan van der

Publication date:

2001

Permanent link:

<https://doi.org/10.3929/ethz-a-004363847>

Rights / license:

[In Copyright - Non-Commercial Use Permitted](#)

Seismische Mess-Systeme



Land



Marine

Seismic System

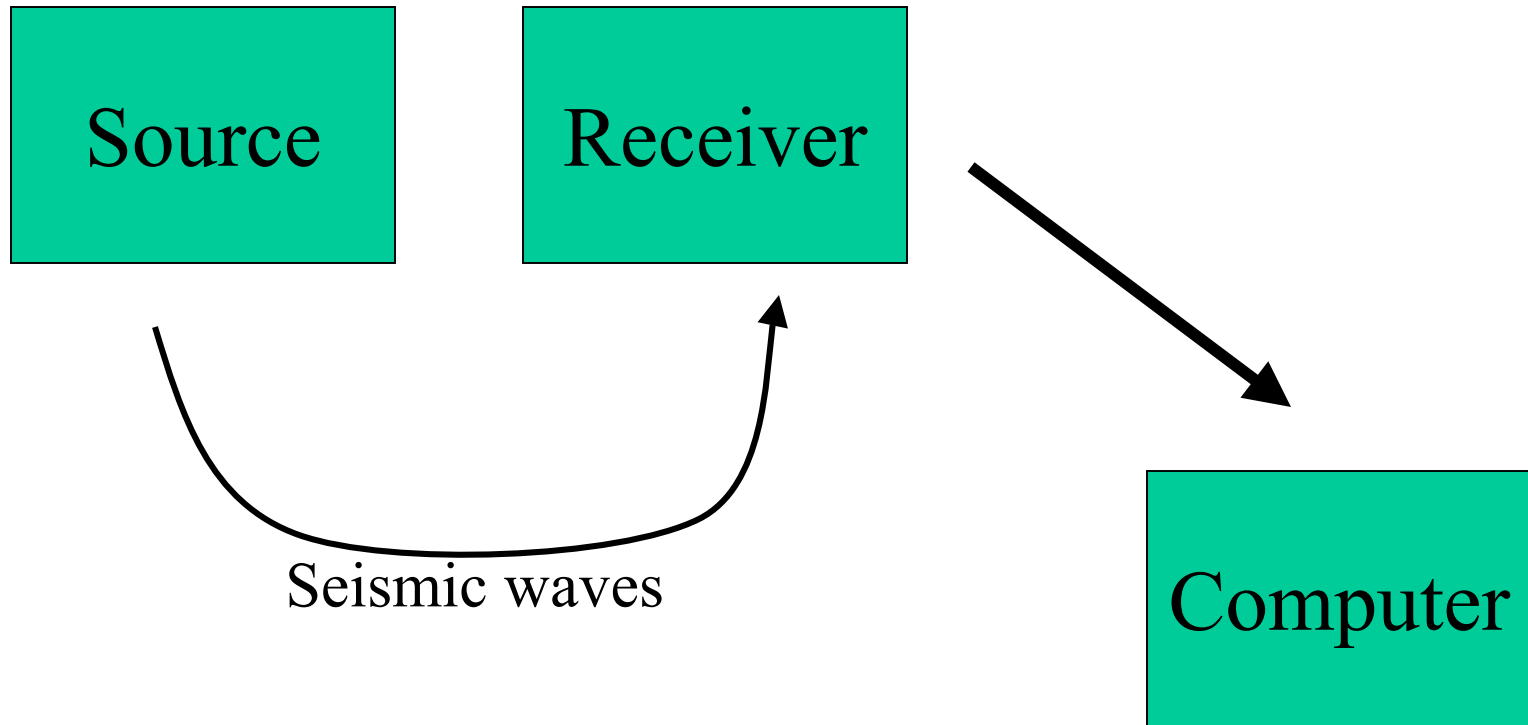

Seismic sources

Important properties:

- Energy
- Waveform
- Repeatability
- Cost and use in the field

Seismic/Acoustic spectrum

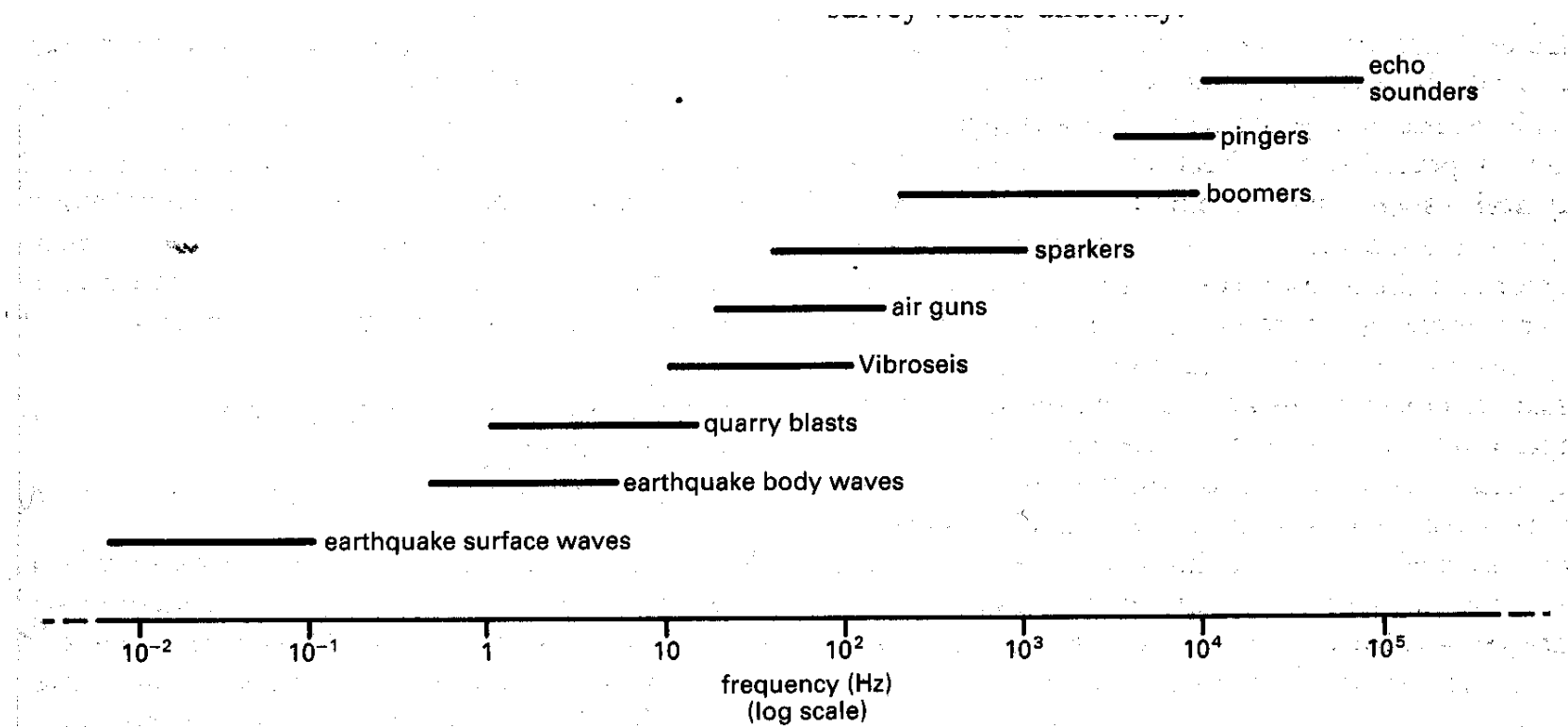

Seismic sources

Impulsive source/Non impulsive source

Explosive source/Non explosive source

Advantages/disadvantages

Dynamite (explosive impulsive source):

- 40% of the seismic measurements
- Not really repeatable
- Exact time of detonation is difficult to obtain
- Detonators are sometimes used for shallow applications
- High energy
- For each application the amount of dynamite can be adjusted

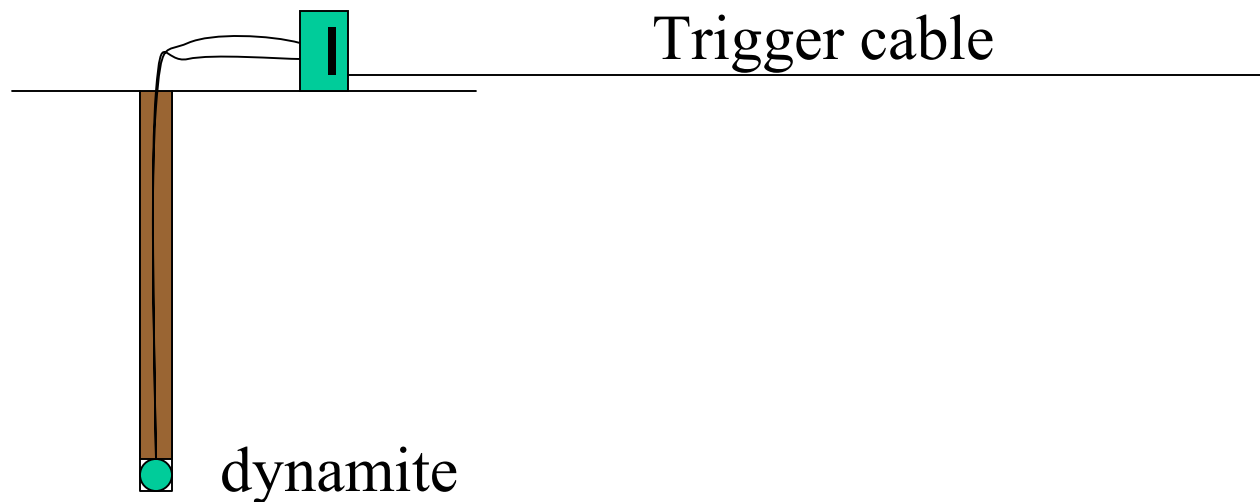



Hammer

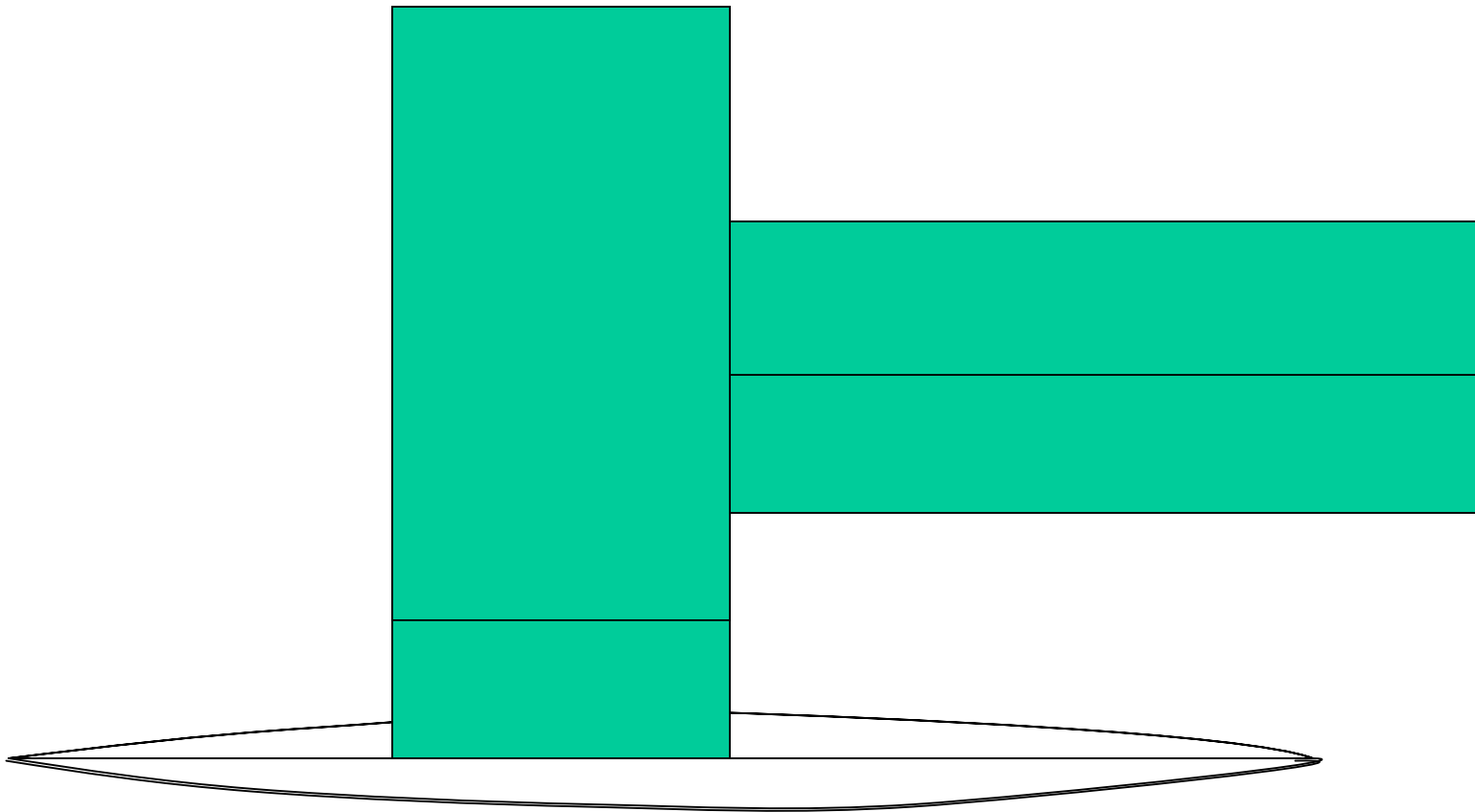

Shear wave hammer

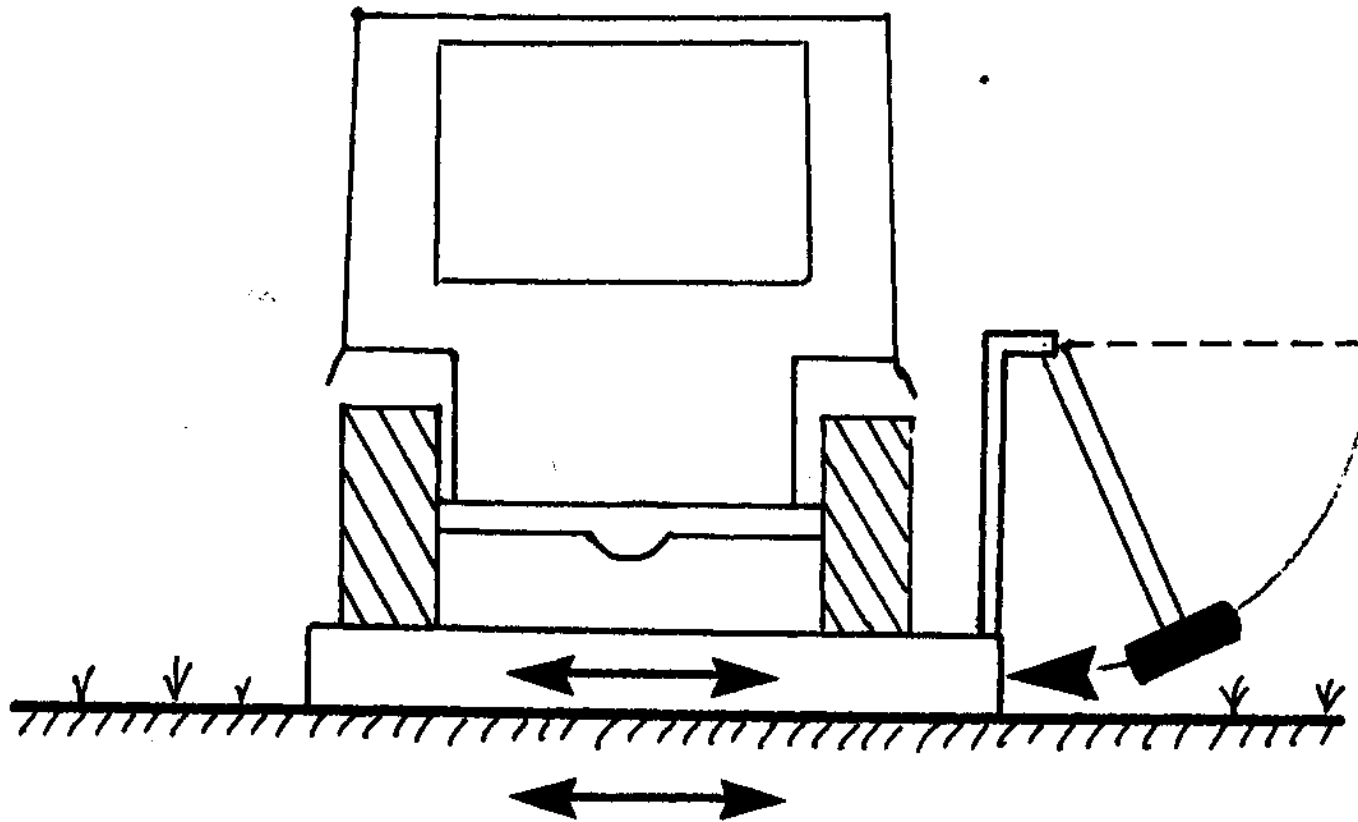



Vibroseis truck

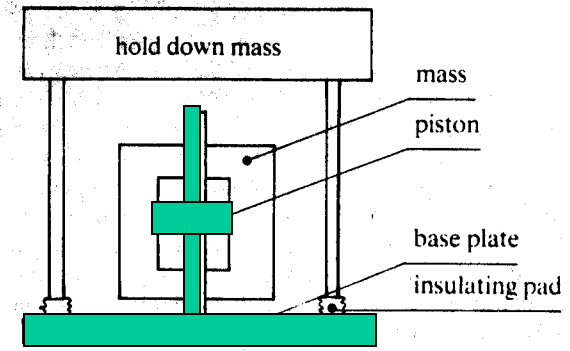

(a)

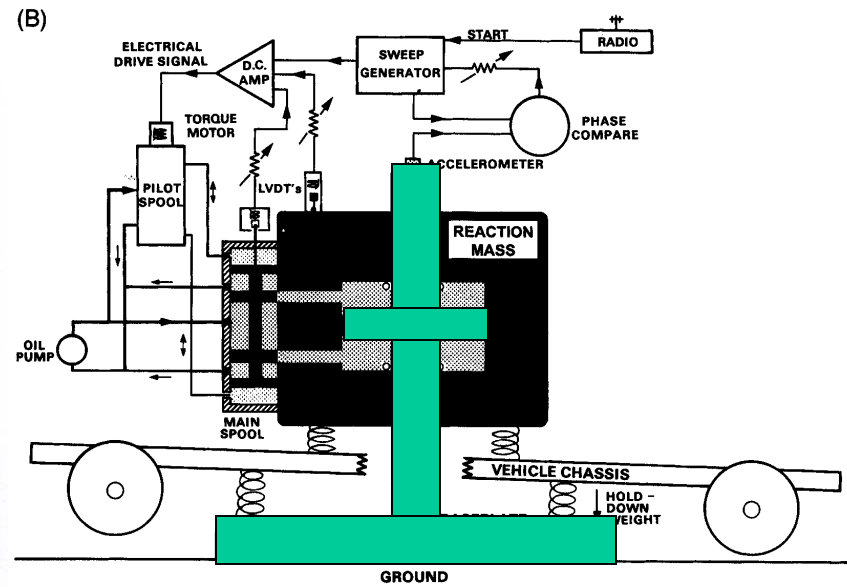
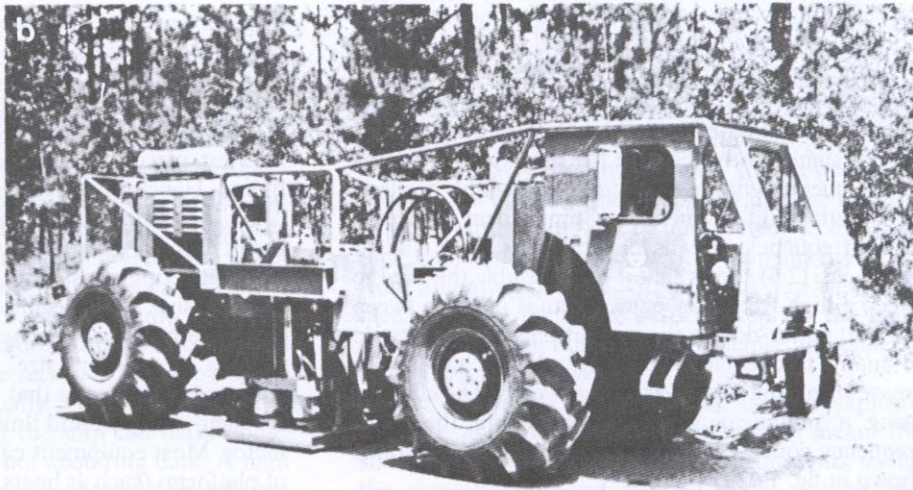

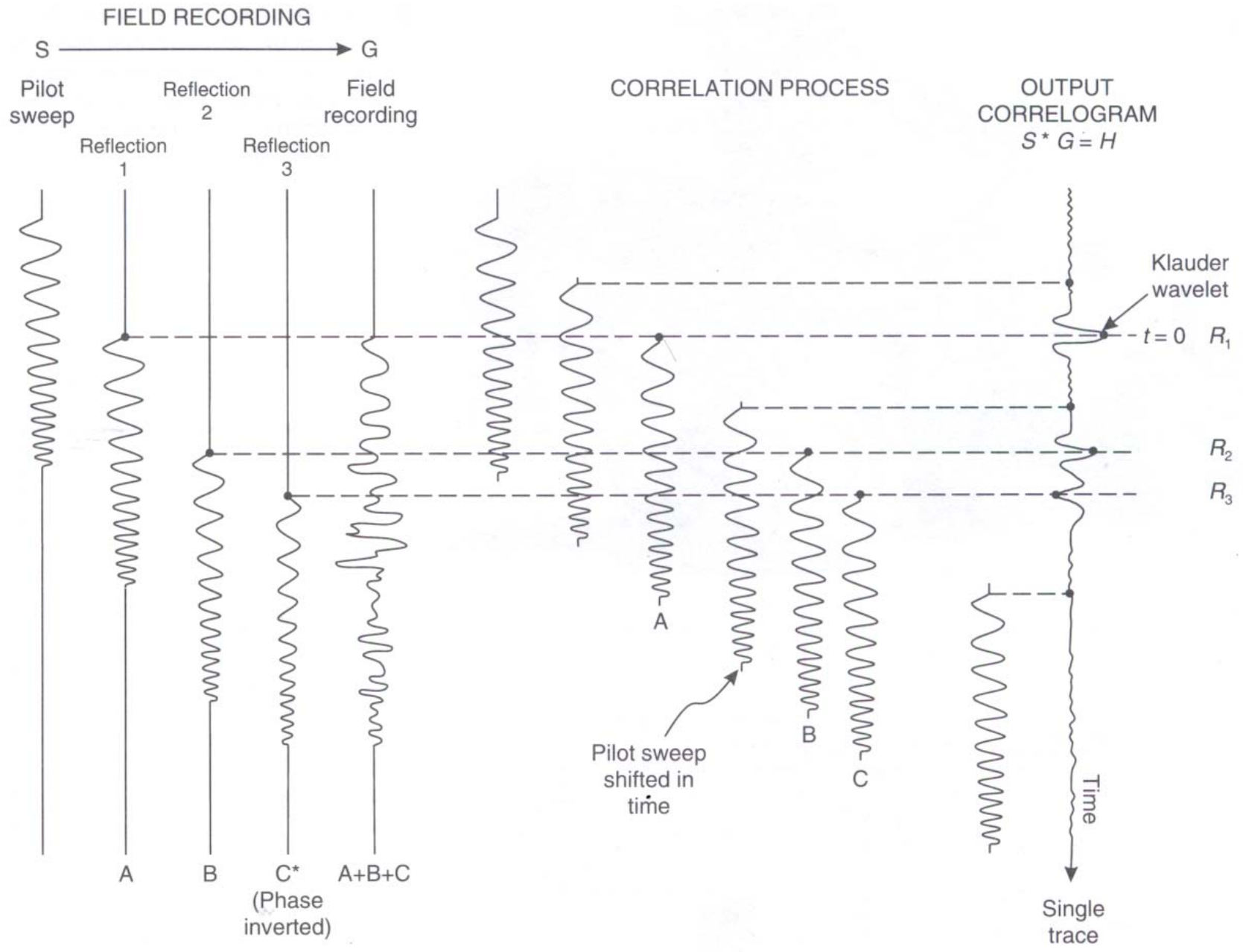

Earliest known seismoscope



Principle of a geophone

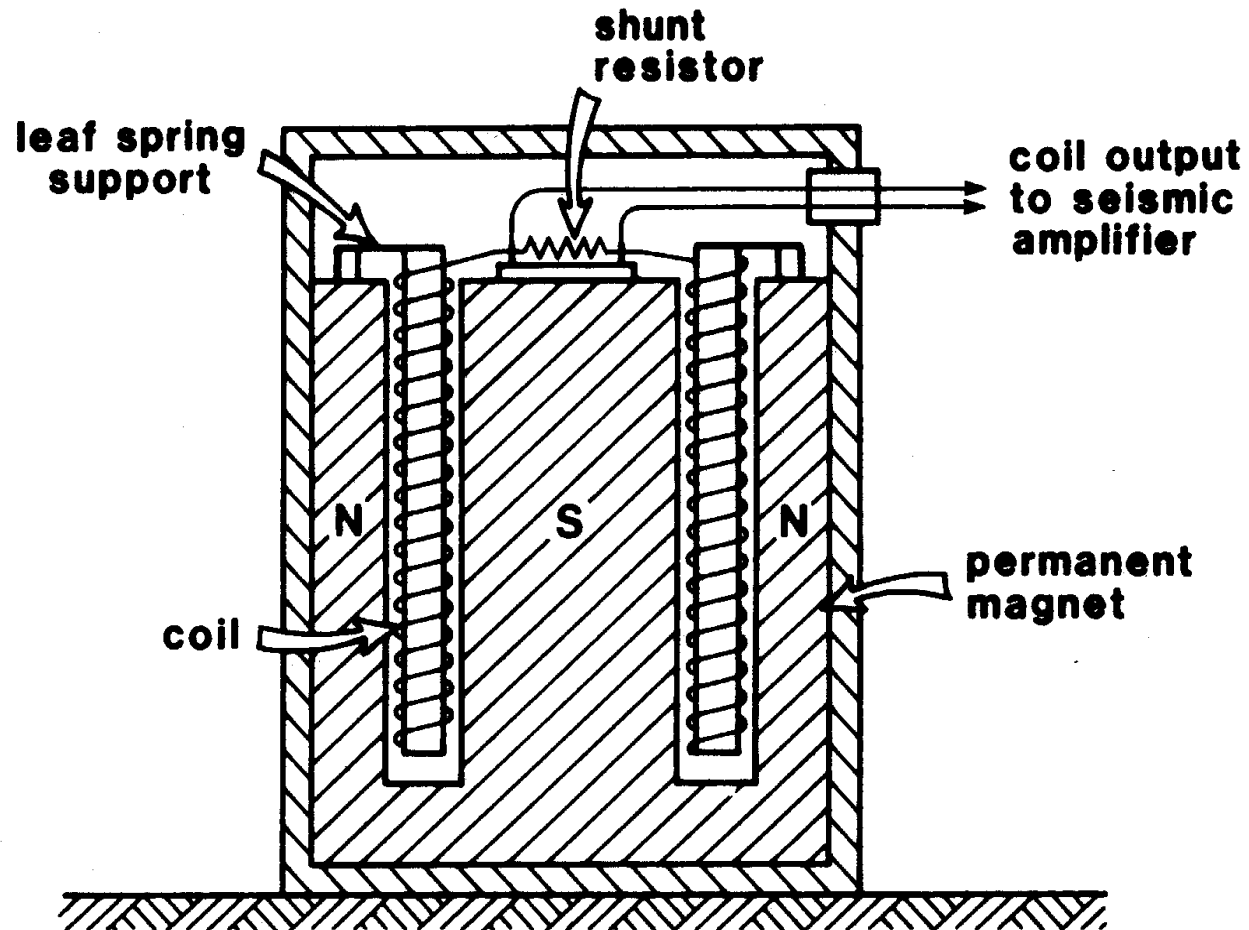

Characteristic of a geophone

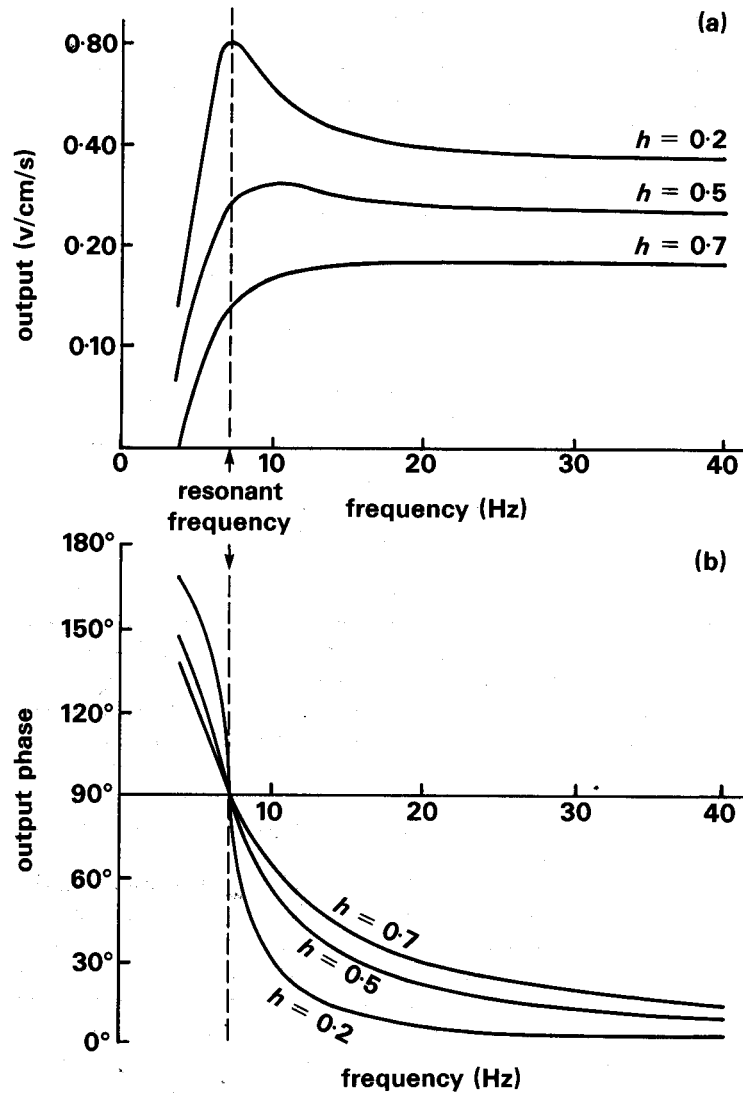

Damping factor h

Array of geophones

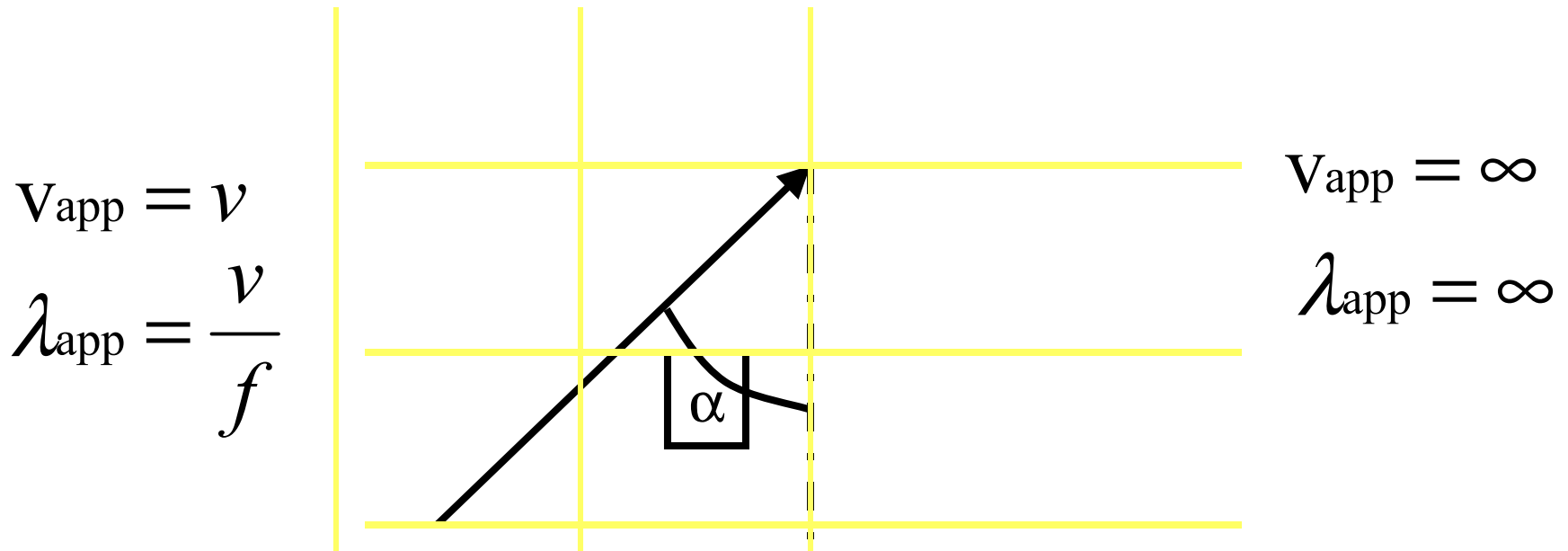

Apparent velocity:

$$V_{\text{app}} = \frac{v}{\sin \alpha}$$

Apparent wavelength:

$$\lambda_{\text{app}} = \frac{V_{\text{app}}}{f}$$



Response function:

$$R = \frac{\sin(n\beta)}{\sin(\beta)}$$

where:

$$\beta = \frac{\pi\Delta x}{\lambda_{app}}$$

And n is the number of geophones in a group

Array response function

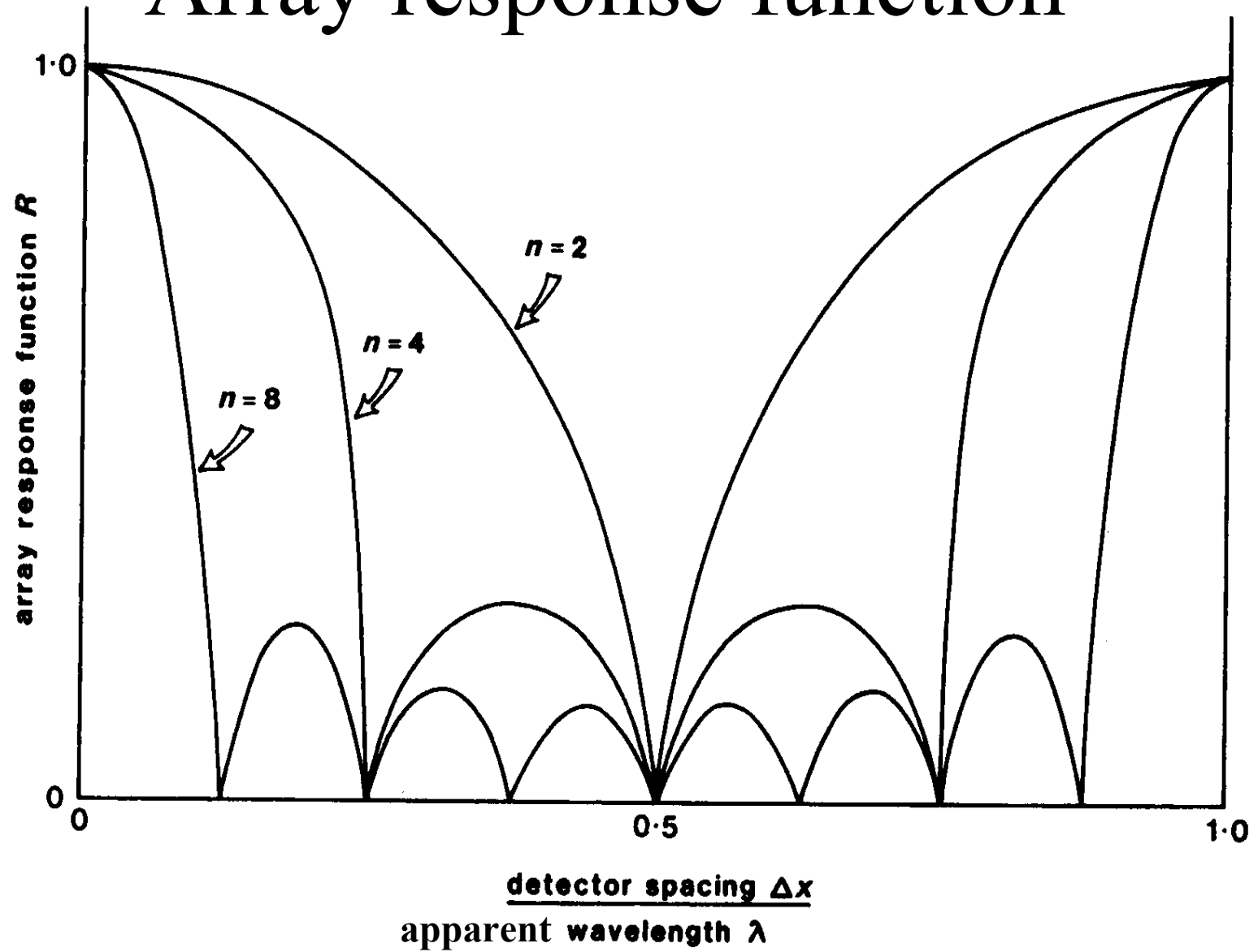

Geophone array

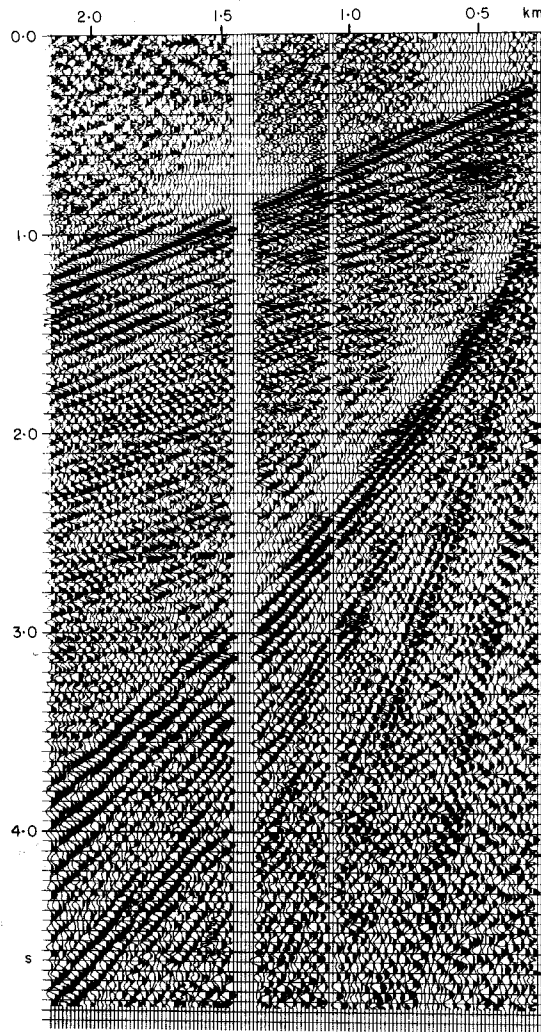

(a)

Clustered geophones

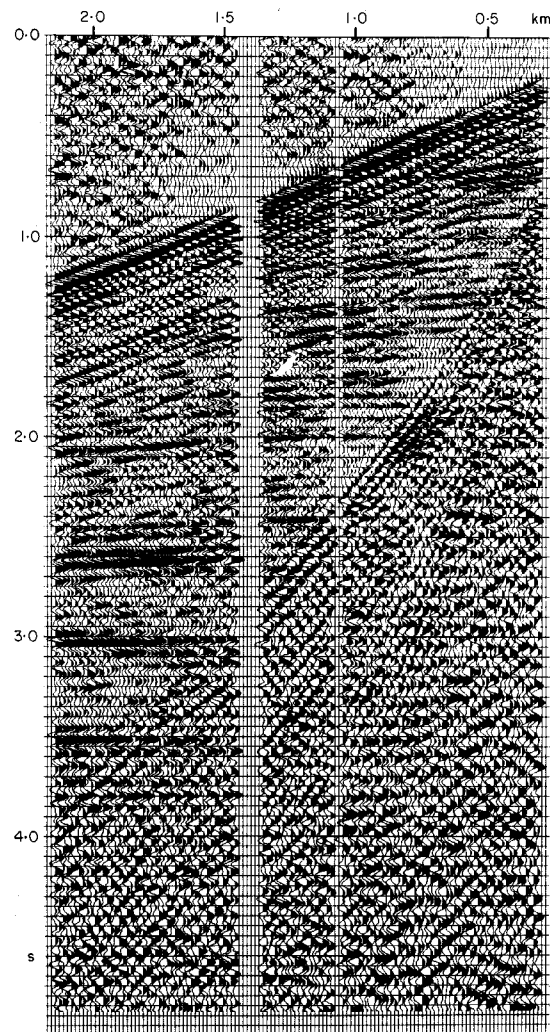

(b)

Geophone arrays



Marine seismic data acquisition



PGS J.W. Schoolmeesters

Chirp



Boomer

sea  **tter**

Modular Cost effective & Affordable



(Huntec-systems)

Principle of an Airgun

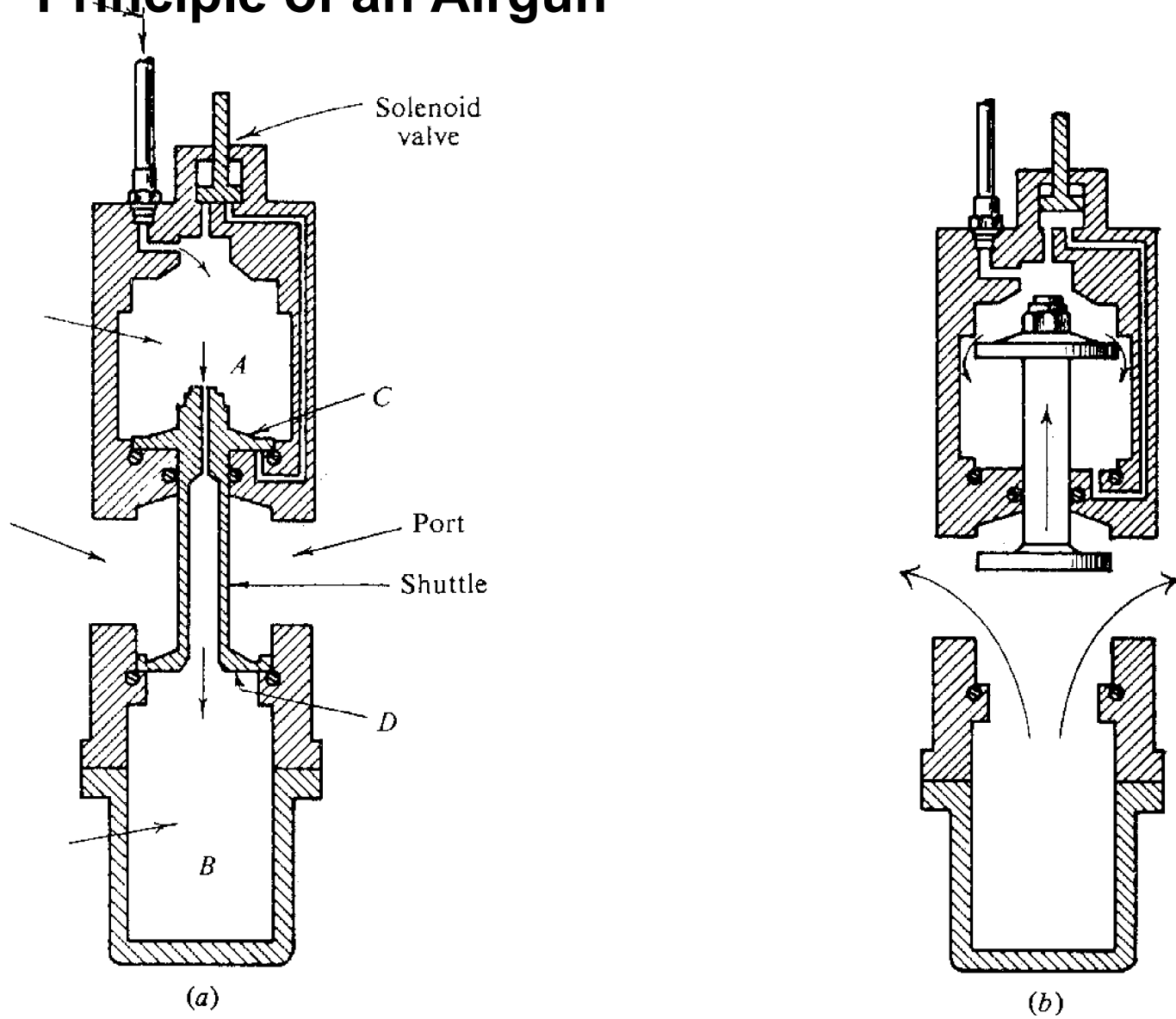

(Bolt-Systems)

Inside of an airgun

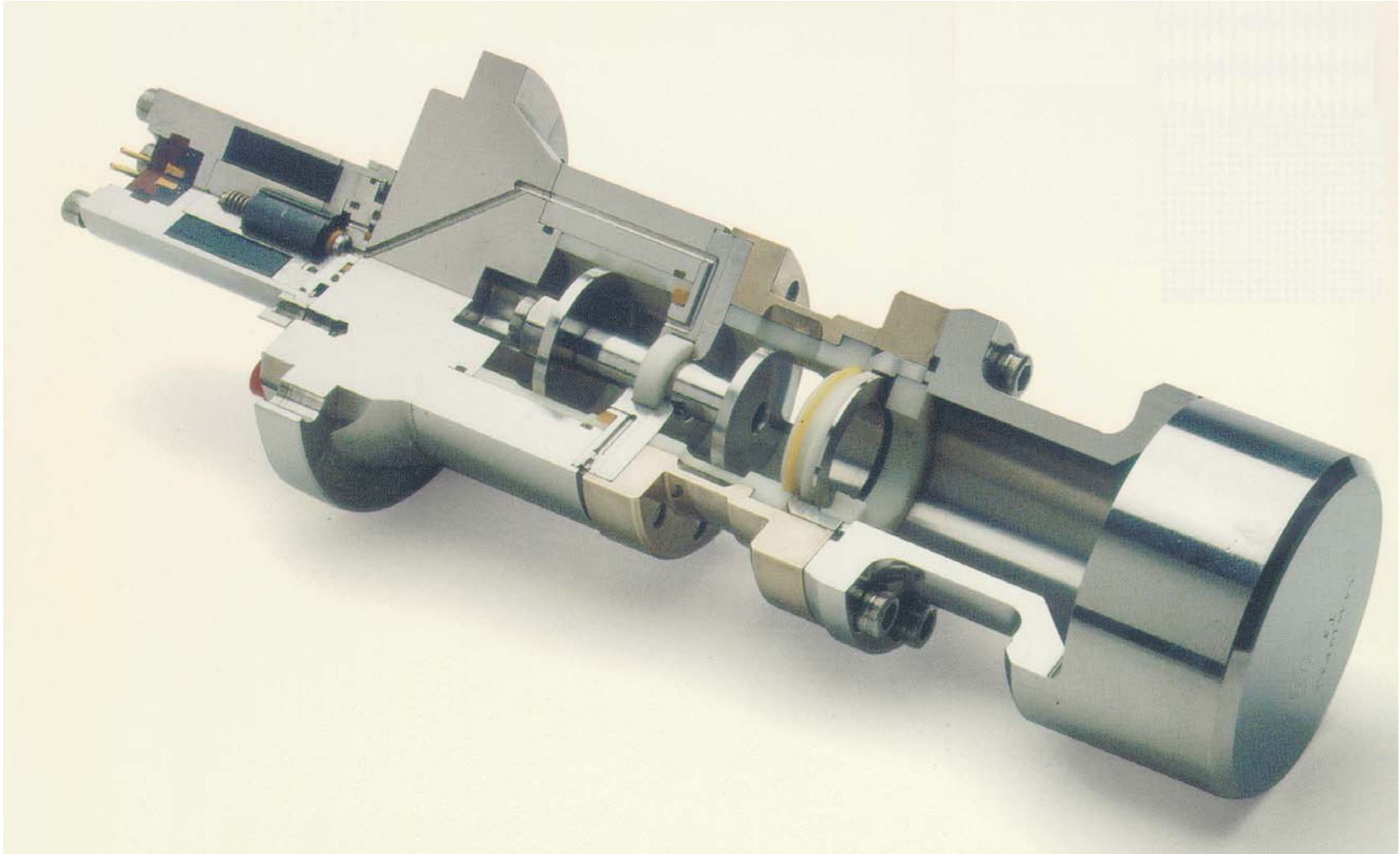

(Bolt-Systems)



Response from an airgun

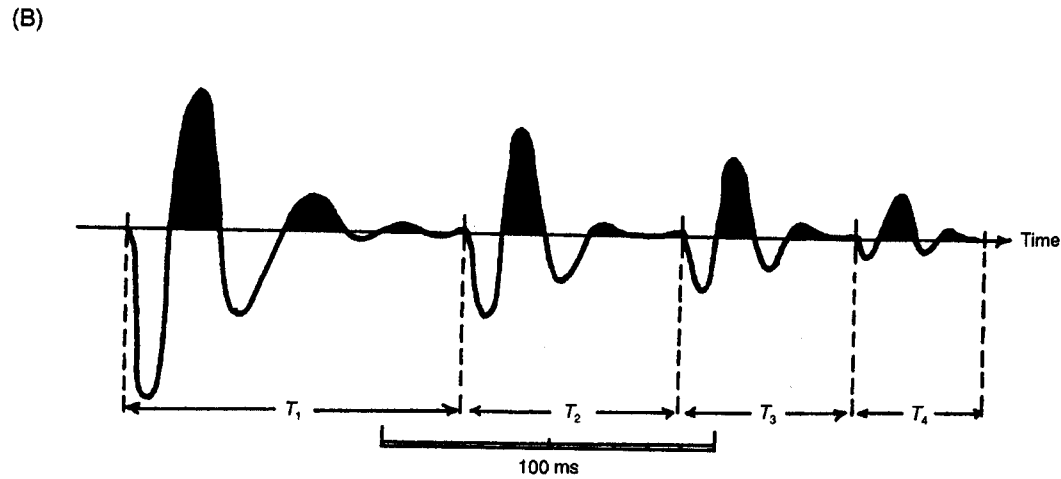
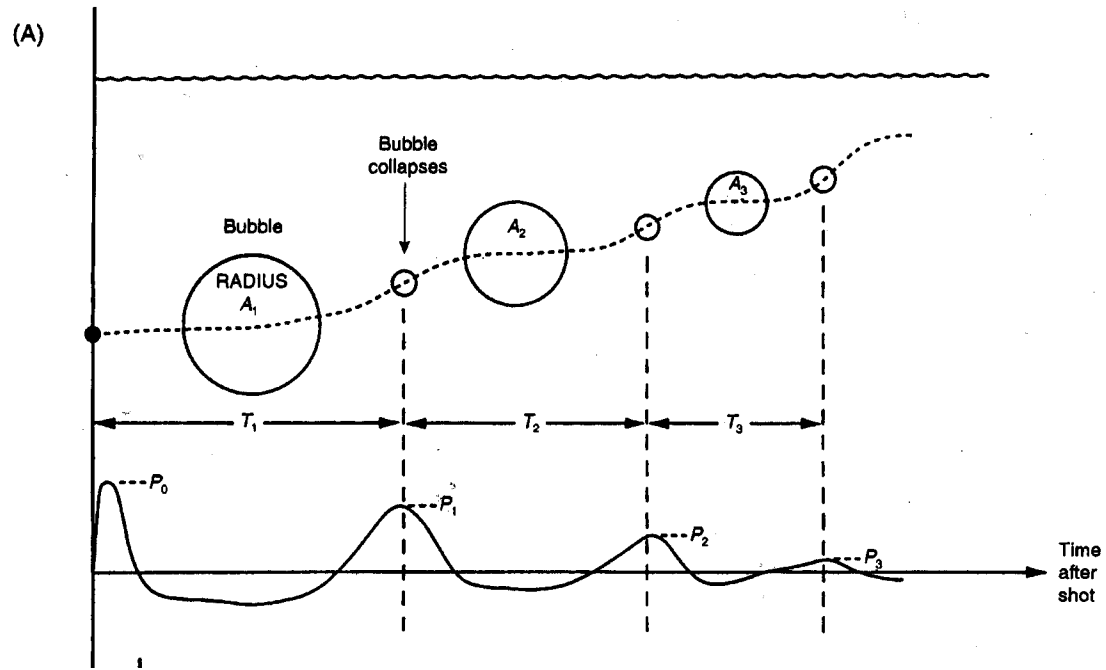

Air gun array

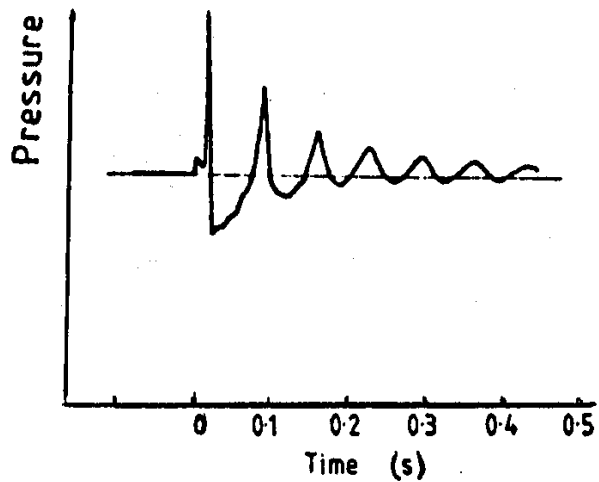

One air gun

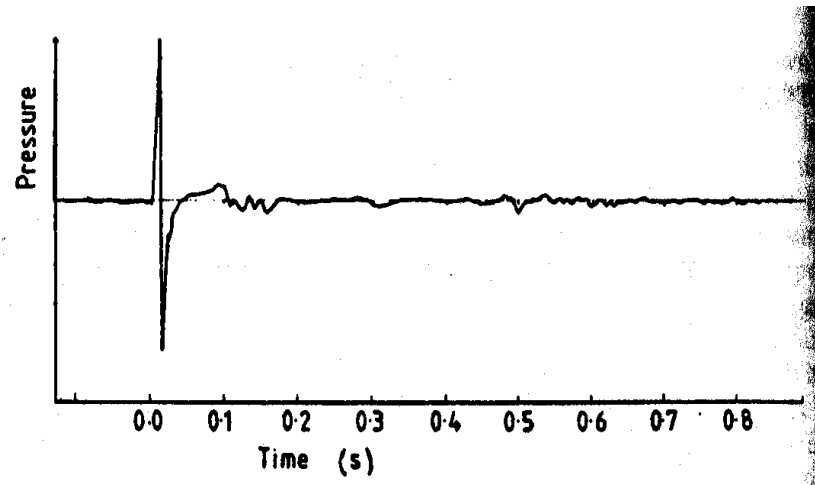

Array of air guns

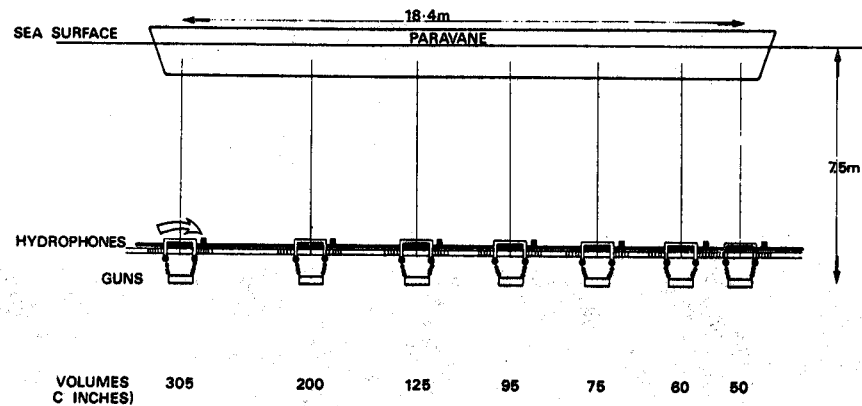

Sonobuoy

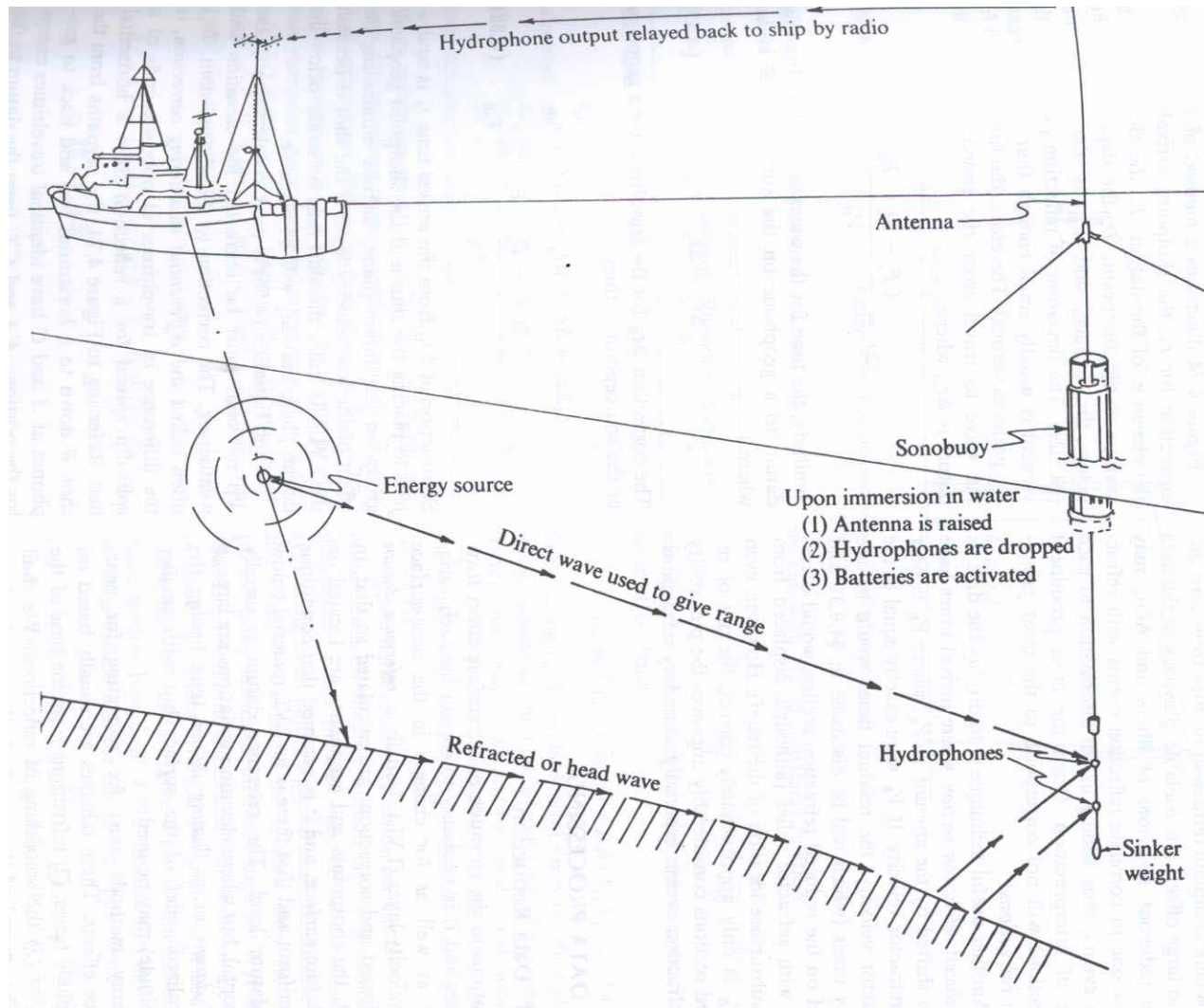

Hydrophone

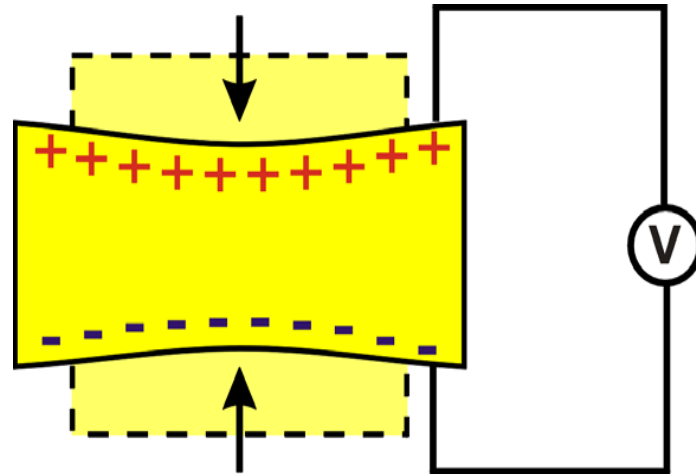

Principle of piezoelectric effect

Voltage proportional to the variation of the pressure

Acquisition Techniques

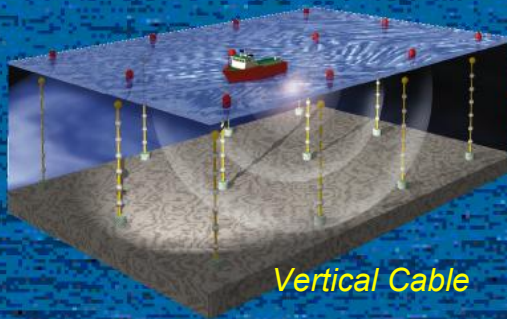

Vertical Cable

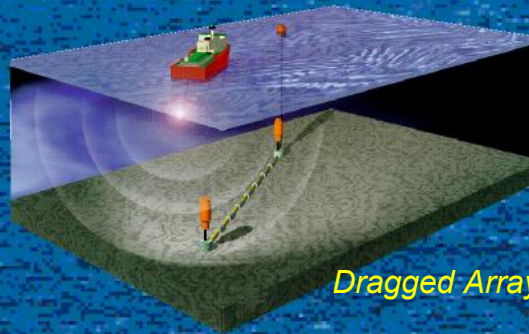

Dragged Array

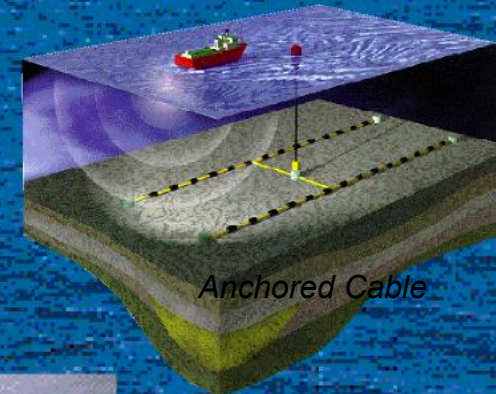

Anchored Cable

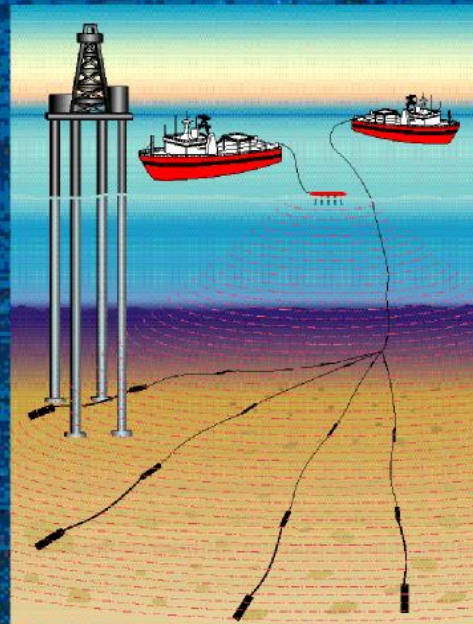

Ocean Bottom Cable



Streamer

Marine streamer

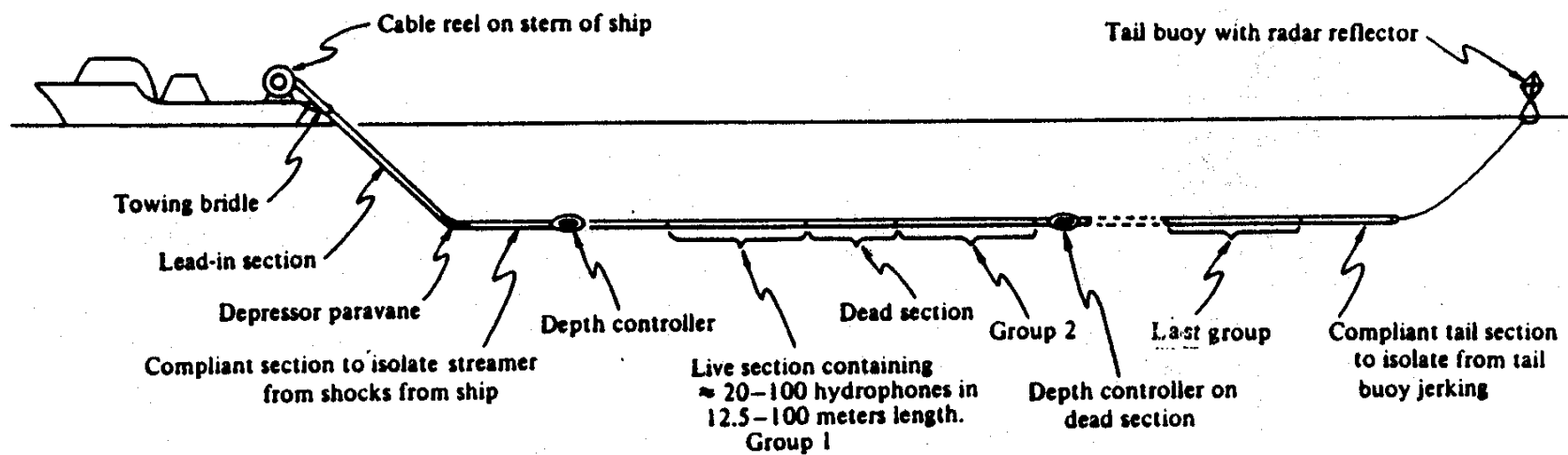



PGS J.W. Schoolmeesters

Tail Buoy





Processing room



Multi-channel seismic recording system

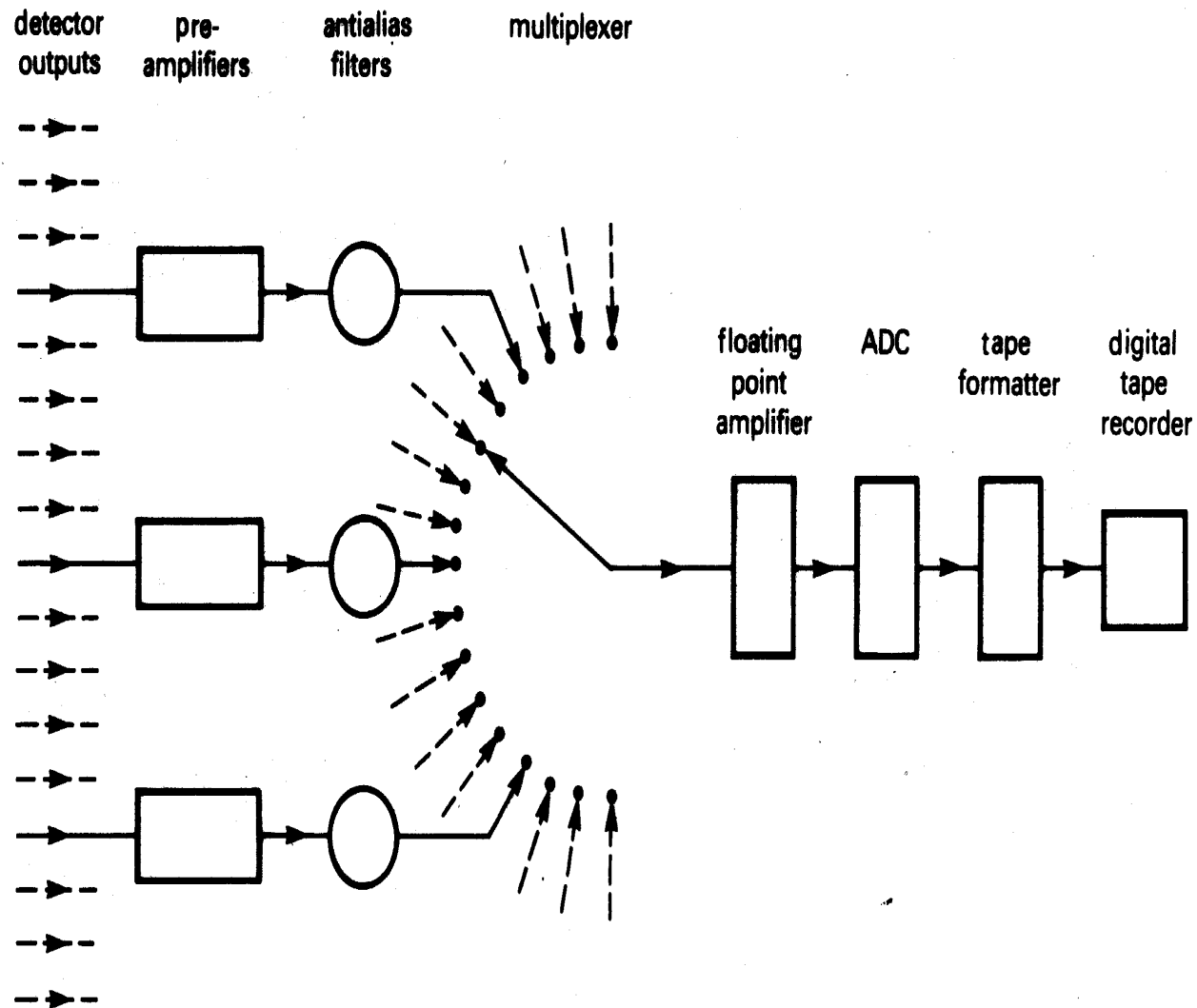

sampling

Registration of the measured data at certain time intervals

Sampling interval Δt

sampling rate $1/\Delta t$

Sampling will preserve all frequencies up to the Nyquist frequency:

$$f_N = 1/(2 \Delta t)$$

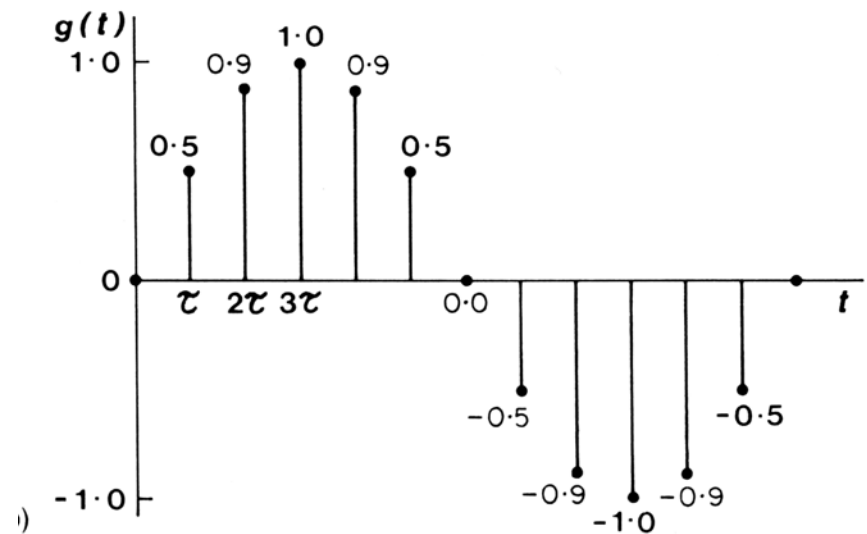
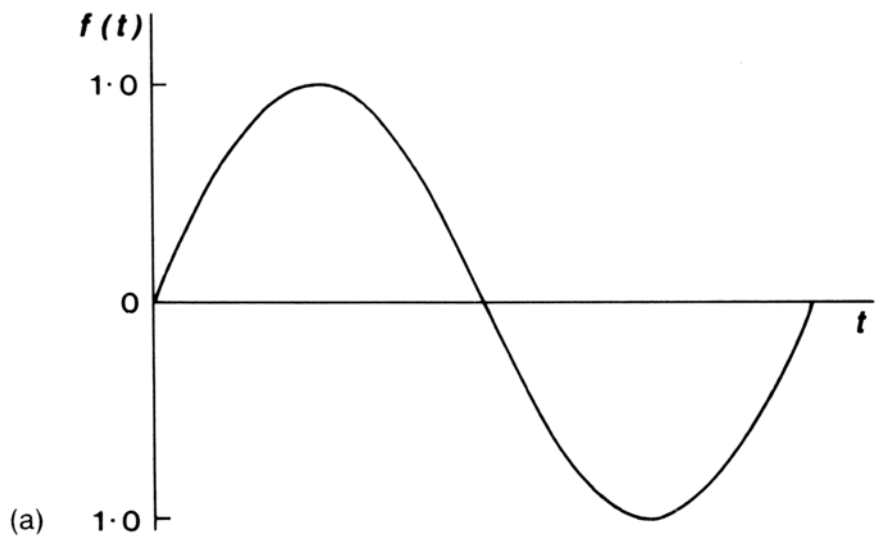

Aliasing

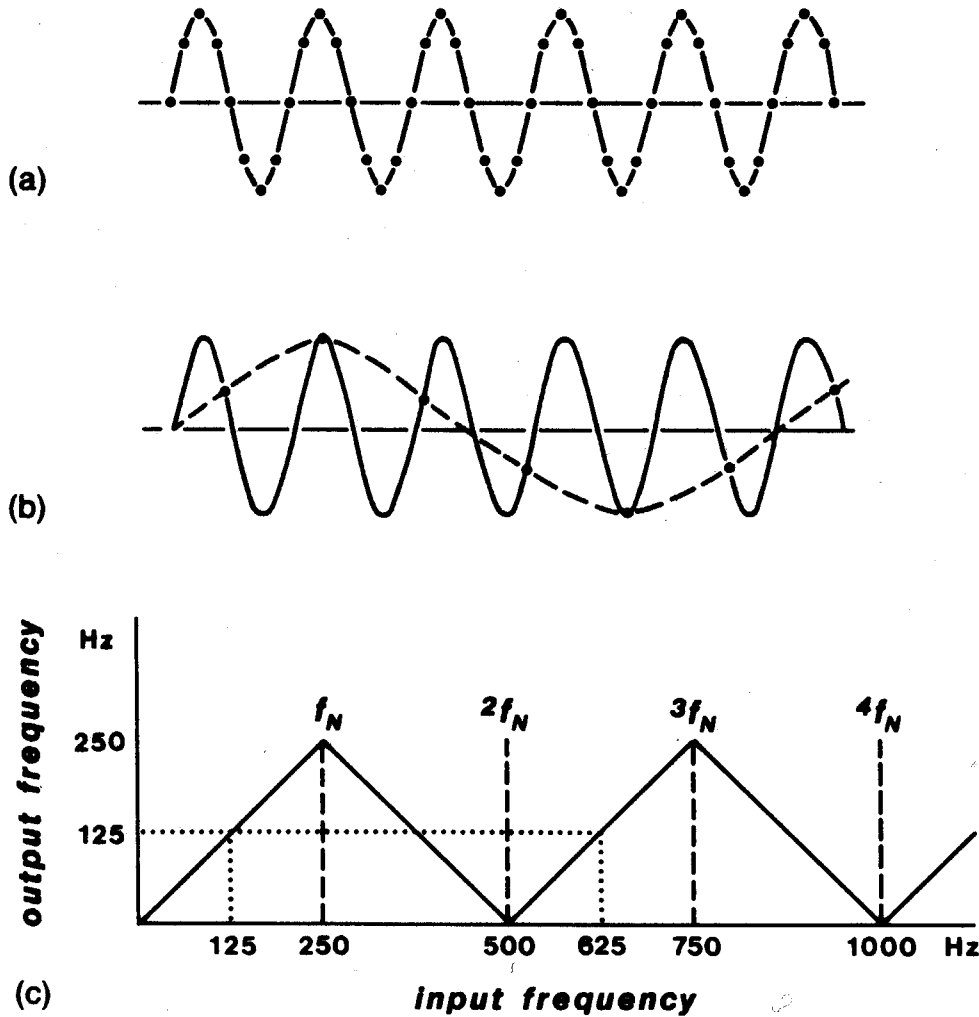

(Kearey and Brooks, 1991)

Nyquist Frequency:

$$f_{Ny} = \frac{1}{2} \frac{1}{\Delta t}$$

Typical sampling distances:

0.25, 0.5 ms:

High resolution seismic

1 ms, 2 ms

Oil exploration

4 ms or larger

Crust seismic

Dynamic range

Range which can be measured using different number of bits:

8-bit : 1 mV - 256 mV

24-bit: 1 μ V - 16 V

Dynamic range is expressed in dB,

$$20 \log \left(\frac{A_{\max}}{A_{\min}} \right)$$

Examples:

$$20 \log \left(\frac{256 \text{mV}}{1 \text{mV}} \right) = 48 \text{dB}$$

$$20 \log \left(\frac{16 \text{V}}{1 \mu \text{V}} \right) = 144 \text{dB}$$

Working of an AD-converter

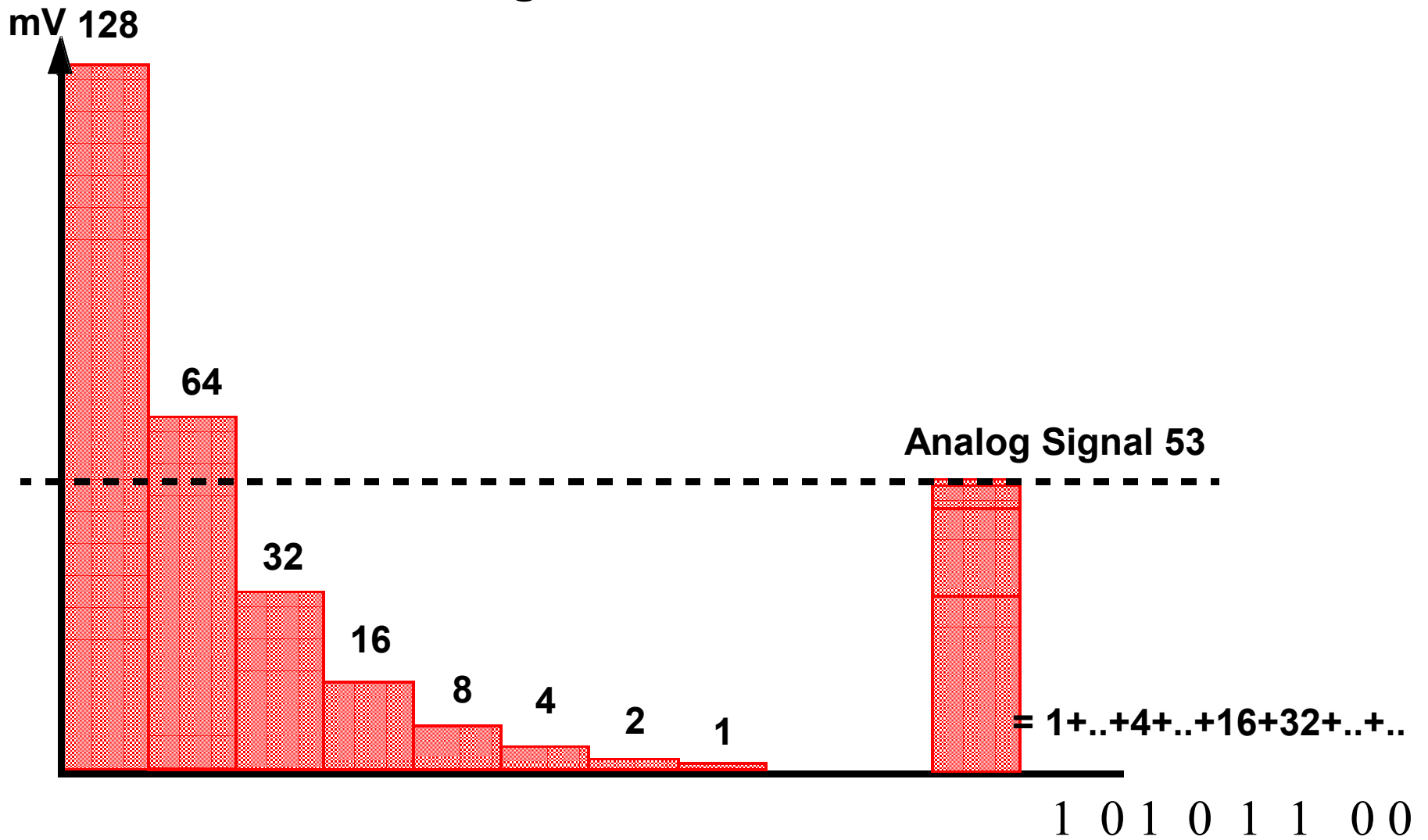

Saving requirements

Saving requirements depend on:

- Number of channels
- Number of values per channel
(Sampling rate, Time window of sampling)
- Number of bytes per sampled value

Example

Channels: 96
Sampling rate: 2 ms
Time window: 0.8 s
Format: 4 Bytes per value

⇒ $(800 / 2) \text{ Values} \times 96 \text{ channels} \times 4 \text{ Bytes} = 0.146 \text{ MBytes}$