

Small-scale steel frames developed for earthquake engineering education purposes

Conference Paper**Author(s):**

Tsiavos, Anastasios; Piskas, Dimitrios; Theodoridou, Sofia; Martakis, Panagiotis; Camathias, Ueli; [Stojadinovic, Bozidar](#) 

Publication date:

2014

Permanent link:

<https://doi.org/10.3929/ethz-a-010315344>

Rights / license:

[In Copyright - Non-Commercial Use Permitted](#)



SMALL-SCALE STEEL FRAMES DEVELOPED FOR EARTHQUAKE ENGINEERING EDUCATION PURPOSES

Anastasios TSIAVOS¹, Dimitrios PISKAS², Sofia THEODORIDOU³, Panagiotis
MARTAKIS⁴, Ueli CAMATHIAS⁵, Bozidar STOJADINOVIC⁶

ABSTRACT

A family of small-scale steel frames is designed, constructed, and subjected to educational earthquake engineering experiments. Based on a three-story moment frame prototype, variants featuring base isolation devices, braces and dampers are developed. Effort is put into achieving realistic vibration characteristics, comparable to real-life multi-story steel structures, nevertheless keeping cost and complexity to a minimum. Experiments include free vibration tests and ground motion excitation using small shaking tables. This set of models constitutes a practical, versatile and easily reproducible teaching tool for structural dynamics and earthquake engineering classes.

INTRODUCTION

Various scale models for classroom use have been proposed so far, typically featuring a simple lumped-mass frame structure with flexible elastic members, yet varying considerably in concept and material used. High flexibility and elastic response are desirable, allowing for large displacements during free vibration tests, and thus distinguishable modal shapes. However, other dynamic characteristics, notably the fundamental period and the damping ratio, are often arbitrarily chosen or implicitly constrained due to materials used.

This study focuses on the design of small-scale steel models with realistic dynamic characteristics, namely mode vibration shapes and periods comparable to those of real-scale multi-story buildings. Such models are not only limited in demonstrating free vibration, but can also be directly excited by available ground motions without the requirement of time scaling, given that the relation between motion frequency content and model eigenfrequencies corresponds to realistic circumstances.

Aschheim and Simsir (2006) have developed small-scale models composed of brass strips and metal connectors as well as low-cost accelerometers (Simsir and Aschheim, 2004) for illustrating simple performance-based design approaches. Terranova and Mosqueda (2009) have presented similar small-scale base isolated models designed using wooden dowels, pegboard, and superglue. The seismic isolation system consisted of furniture gliders and rubber bands. Such models are often used to

¹ Doctoral Student, ETH , Zurich, tsiavos@ibk.baug.ethz.ch

² Graduate Student, ETH , Zurich, piskasd@student.ethz.ch

³ Graduate Student, ETH , Zurich, tsofia@student.ethz.ch

⁴ Graduate Student, ETH , Zurich, martakip@student.ethz.ch

⁵ Graduate Student, ETH , Zurich, cueli@student.ethz.ch

⁶ Professor, ETH , Zurich, stojadinovic@ibk.baug.ethz.ch

raise awareness of earthquake engineering (Crewe, et al. 2008, Mendoza, et al., 2008), but present difficulties when the students are asked to relate the behaviour of model buildings to that of real structures. Small-scale steel frames are more realistic, and they have already been used for research purposes (Mills and Krawinkler 1980, Lignos, et al. 2008).

The goal of the project presented in this paper was to design a series of small-scale moment-resisting frames with realistic dynamic properties that can be constructed easily with widely available materials and off-the-shelf components. Two important additional requirements were: 1) to make it possible to use conventional response modification techniques, such as added damping or seismic isolation, to modify their response; and 2) to make it possible to use simple, few-degree-of-freedom, computer models to simulate their response to various dynamic excitations. The small-scale steel buildings presented in this paper are versatile, cost-effective, easy to build, maintain and modify. They feature fairly realistic vibration characteristics that are directly comparable to actual buildings. They can be used to perform a wide variety of classroom and laboratory demonstrations, ranging from structural identification to shaking-induced yielding and collapse mechanism demonstration. Back-calculating their properties to calibrate an analytical or FEM model is also an interesting task that can be left as a modelling challenge for students. Finally, with appropriate modifications, researchers can also use them to experimentally investigate their assumptions on small-scale models before embarking on full-scale tests.

CONSTRUCTION

The driving requirements for the design of these models were (a) realistic vibration characteristics, (b) ease of construction and use, (c) cost effectiveness. Complexity of the assemblages was kept to a minimum, and elaborate structural members were avoided. Simple elements such as steel plates and strips were used as floor slabs and columns. All connections are realized using threaded bolts. They were manufactured using ordinary laboratory equipment and processes (cutting, spraying, screw-threading and bolting). All structures were principally designed as moment-resisting frames, flexible in one plane and rigid in the perpendicular plane. Starting from the three-story moment frame prototype, various modifications, such as changes in geometry or addition of braces, dampers and isolators, lead to further models.

MODEL 1: THE PROTOTYPE FRAME

The original three-story model, Model 1, is designed as a simple moment frame with a fundamental period of 0.5 sec.

Figure 1 shows four different technical drawings of the building, a front view, a side view, a story plate and a base plate view. As shown in the figure, the building plan is rectangular. The frame consists of four massive, rigid steel slabs and four light, flexible columns. The bottom slab serves to anchor the model to the test frame or the shaking table, making this structure behave as a three-degree-of-freedom dynamic system. The seated-angle connections between the columns and the floor plates are intended to behave as rigid.

The component dimensions and quantities used are summarized in Table 1. The plates (Part No 1), the columns (Part No 2) and the L-shaped connections (Parts No 3, 4) are all shown in red circles in the 3D view of the three-story small-scale moment resisting frame (Fig. 2).

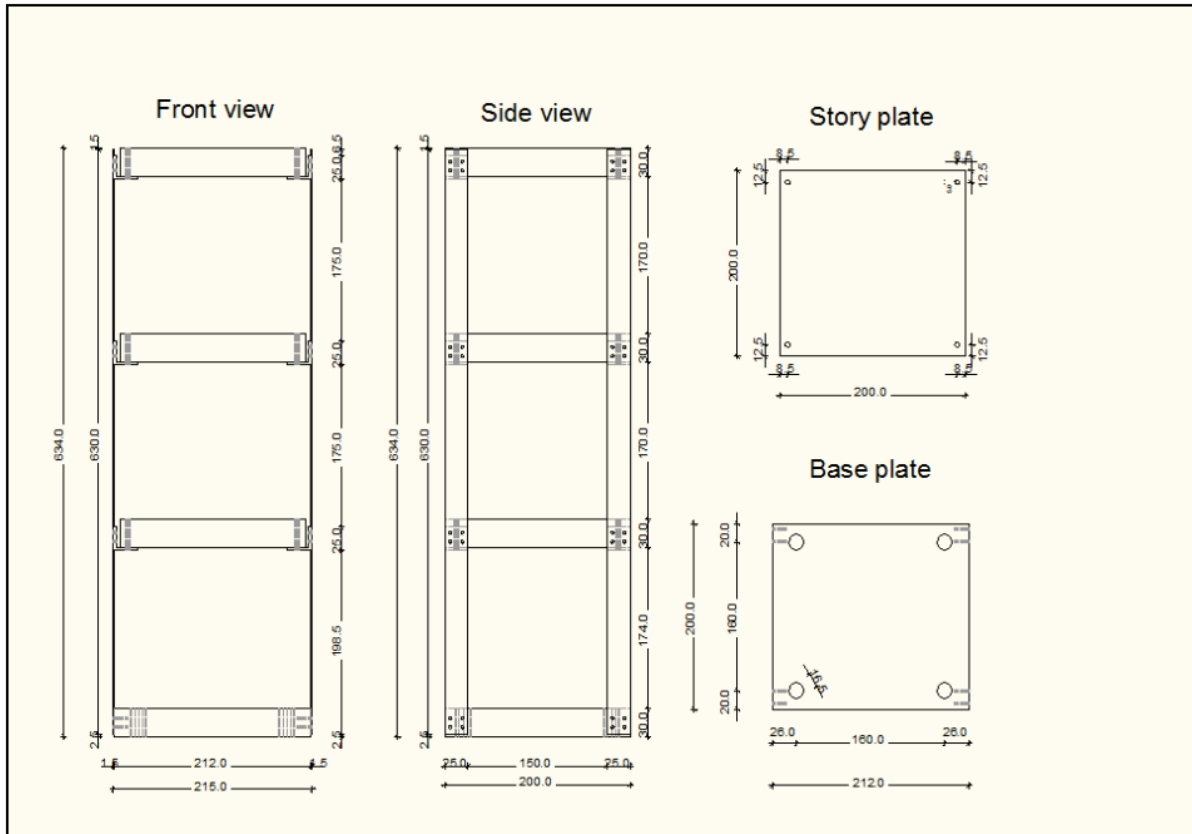

Figure 1. Design plan of a three-story small-scale moment resisting frame (Model 1)

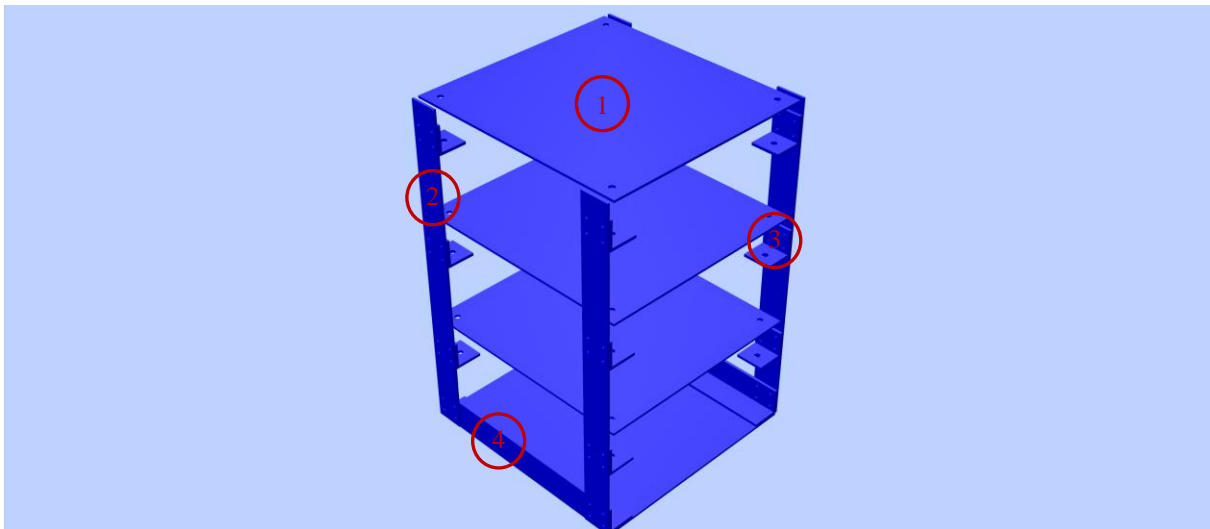

Figure 2. 3D View of a three-story small-scale moment resisting frame (Model 1)

Table 1: Materials and components of the three-story moment resisting frame

Part	Number of elements	Material	Quality	Length (cm)	Width (cm)	Thickness (cm)
1. Plates	4	Steel	S235	20	20	3
2. Columns	4	Steel	S235	60	2.5	0.15
3. L-shaped connections-Masses	12	Steel	S235	2.5	2.5	0.20
4. L-shaped connections-Base	2	Steel	S235	20	2.5	0.20

MODEL 2: EQUIVALENT SDOF FRAME

A single-degree-of-freedom (SDOF) structure, Model 2, shown in Figure 3(a) is the equivalent of Model 1 in terms of its fundamental period. The same components were used, therefore the mass of the degree of freedom and the column section are given. The story height was increased to produce the desired fundamental vibration period. The bill of materials is shown in Table 2. The resulting structure is significantly more deformable than Model 1. Even though the buckling length is also larger, the weight is also reduced, making buckling an unlikely failure mode. Therefore, dynamically, Model 2 is as stable as Model 1.

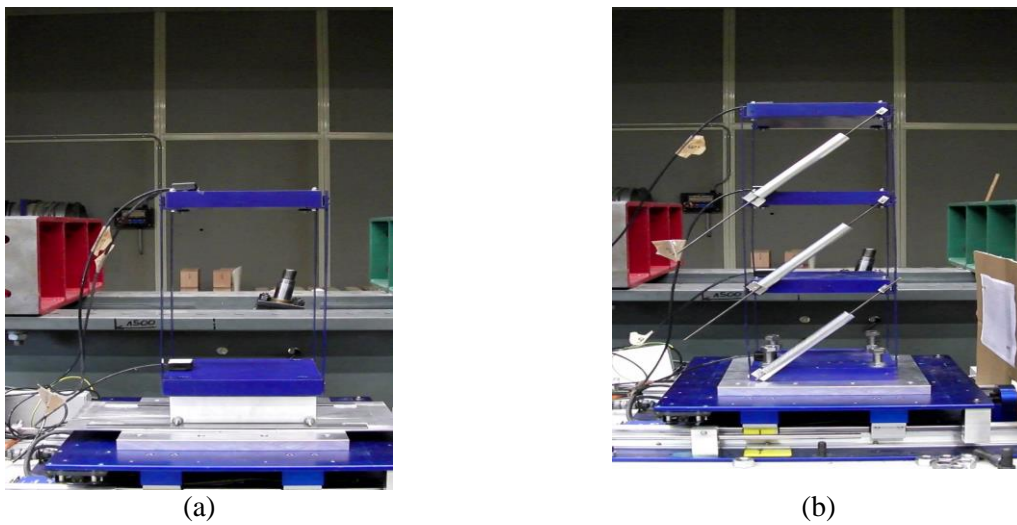

Figure 3. The equivalent SDOF small-scale moment resisting frame (a) and the small-scale three-story damped frame (b)

Table 2: Materials and components of the equivalent SDOF system

Part	Number of elements	Material	Quality	Length (cm)	Width (cm)	Thickness (cm)
1. Plates	2	Steel	S235	20	20	3
2. Columns	4	Steel	S235	35	2.5	0.15
3. L-shaped connections-Masses	12	Steel	S235	2.5	2.5	0.20

MODEL 3: DAMPED FRAME

Model 1 frame was reproduced and equipped with a damping system to make Model 3 (Figure 3(b)). A damper is made using a steel rod inserted into an aluminum tube filled with lightweight granular material (rice or sand). Damping occurs through friction between the steel bar and the tube filling. The advantage of this bracing system is that it is very easy to make and that the friction between the granular material and steel bar is fairly constant in time.

Table 3: Materials and components of the damped three-story moment resisting frame

Part	Number of elements	Material	Quality	Length (cm)	Width (cm)	Thickness (cm)	Radius (cm)
1. Plates	4	Steel	S235	20	20	3	-
2. Columns	4	Steel	S235	60	2.5	0.15	-
3. L-shaped connections-Masses	12	Steel	S235	2.5	2.5	0.20	-
4. L-shaped connections-Base	2	Steel	S235	20	2.5	0.20	-
5. Tubes	3	Aluminium	AW6026	20	-	0.15	1.0
6. Steel bars	3	Steel	S235	20	-	-	0.15

MODEL 4: BASE-ISOLATED FRAME

Model 4, shown in Figure 4, is a copy of Model 1 frame with added seismic base isolation. The seismic isolation system for this model is designed to have a fundamental period of 1.5 sec. The base isolation system consists of a one-direction railing system combined with a central core of rubber. The material used for the rubber isolator was a rubber granulate with $G=2.0$ MPa at a temperature of 20 °C. The superstructure is mounted on the railing system, which transfers the vertical load to the ground (seismic table), while it moves freely in the horizontal direction. The deformable rubber provides horizontal resistance and restores the system to its initial position. The combined use of steel wheels for vertical load and rubber for horizontal resistance creates a hybrid system that protects the isolators from buckling. A similar solution was proposed by Hamaguchi and Higashino (2000). All of the Model 4 components are listed in Table 4.

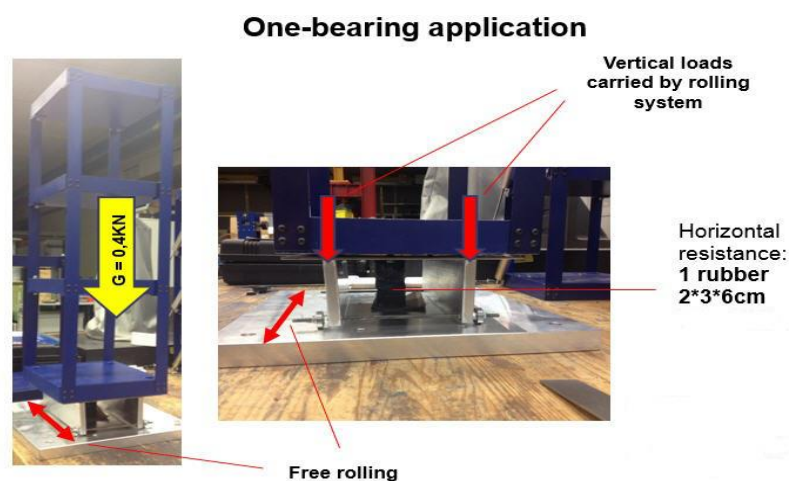

Figure 4. View of the base-isolated three-story moment resisting frame

Table 4: Materials and components of the base-isolated three-story moment resisting frame

Part	Number of elements	Material	Quality	Length (cm)	Width (cm)	Thickness (cm)	Radius (cm)
1. Plates	4	Steel	S235	20	20	3	-
2. Columns	4	Steel	S235	60	2.5	0.15	-
3. L-shaped connections-Masses	12	Steel	S235	2.5	2.5	0.20	-
4. L-shaped connections-Base	2	Steel	S235	20	2.5	0.20	-
5. Additional plate for railing system	1	Steel	S235	20	20	0.2	-
6. Blades	2	Aluminium	AW6026	20	6	1	-
7. Wheels	4	Aluminium	AW6026	-	-	0.5	1.5
8. Rod (Axis)	2	Steel	S235	16	-	-	0.3
9. Rubber	1	Elastomeric	Granulate	2	3	6	-

ANALYTICAL MODELING

Analytical and numerical modeling of the structures discussed above has been applied both in advance of construction and afterwards. In the pre-dimensioning phase, analytical modeling is as a handy ‘what-if’ design tool, whereas numerical modeling is applied in subsequent steps in order to capture details of the response. For the former, the MATLAB programming was used. For the latter, the SAP2000 modeling package was used.

EXPERIMENTAL SETUP

A series of tests has been performed to validate the vibration characteristics of the models and to illustrate the differences in the response of different types of structures subjected to earthquake excitation. The experimental setup consists of the one-direction shaking table with dimensions 45.7 cm × 45.7 cm, as shown in Figure 5(a). Each of the models is mounted on the top plate of the shaking table using an adapter plate. The responses of the models were measured using accelerometer, one mounted on each mass of the tested model, as shown in Figure 5(b).

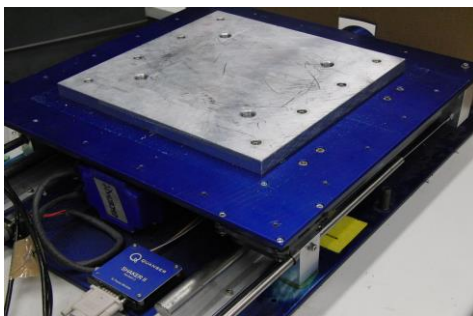

(a) Shaking table with the adapter plate



(b) Accelerometer attached to a floor

Figure 5. Test setup

The ground motion that was chosen to excite the models is the 1979 El Centro record (Imperial Valley 10/15/79 2316, El Centro array #4, 140, USGS station 955). This ground motion was scaled by 0.3 to fit into the mechanical capabilities of the shaking table. The applied record is shown in the Figure 6.

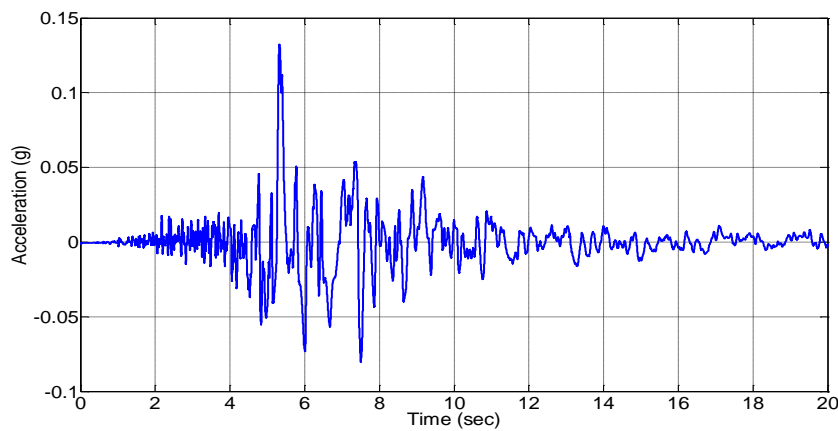

Figure 6. Ground motion excitation

VIBRATION PROPERTIES

The vibration characteristics of the three-DOF models were obtained by performing a Fourier transform of the response data measured during the ground motion excitation of the structures. The dominant frequencies of the three models are shown in the Fourier spectrum in Figure 7 and listed in Table 5.

Table 5. Mode vibration periods of the models.

[sec]	Mode 1	Mode 2	Mode 3
Model 1	0.57	0.18	0.12
Model 2	0.57	n/a	n/a
Model 3	0.47	0.16	0.11
Model 4	1.47	0.64	0.31

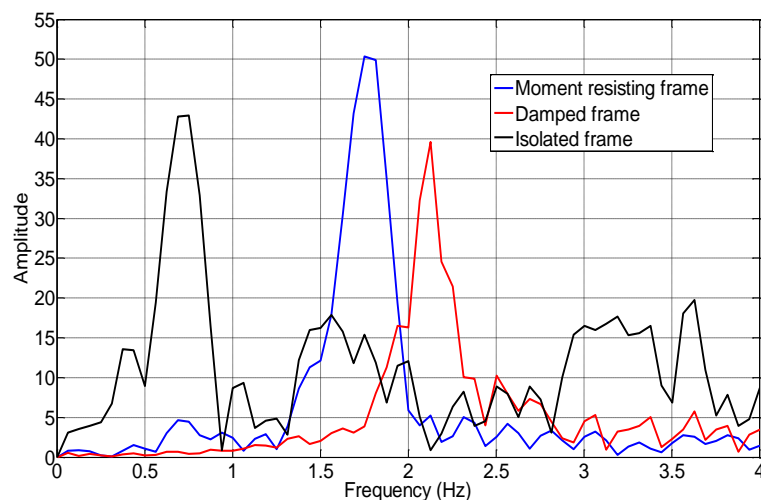

Figure 7. Dominant frequencies of different structures calculated with Fourier Spectra

As presented in Table 5 and Figure 7, the dominant frequency of the moment resisting frame is 1.75 Hz, which translates into the fundamental vibration period of 0.57 sec. The damped steel frame is stiffer with a dominant frequency of 2.12 Hz and a corresponding fundamental vibration period of 0.47 sec. The observed values are close to the analytically computed values, and show that the goal of constructing small-scale conventional three-story frames with realistic vibration characteristics was achieved. The fundamental vibration frequency of the seismically isolated structure is significantly lower, namely 0.75 Hz, corresponding to the isolation period of 1.47 sec. Such three-fold period elongation is typical of isolating a moment resisting frame structure (Kelly, 1997). While a typical isolation period design target is between 2 sec and 3 sec, there are seismically isolated structures with an isolation period of 1.5 sec.

RESPONSE TO GROUND MOTION EXCITATION

The responses of Models 1 and 4 to the selected ground motion recorded at the top floor of these structures is shown in Figure 8. The response of Model 1, the fixed-base moment resisting frame is predominantly in its fundamental vibration mode. The effectiveness of seismic isolation towards reducing the motion and acceleration of the isolated structure is clear.

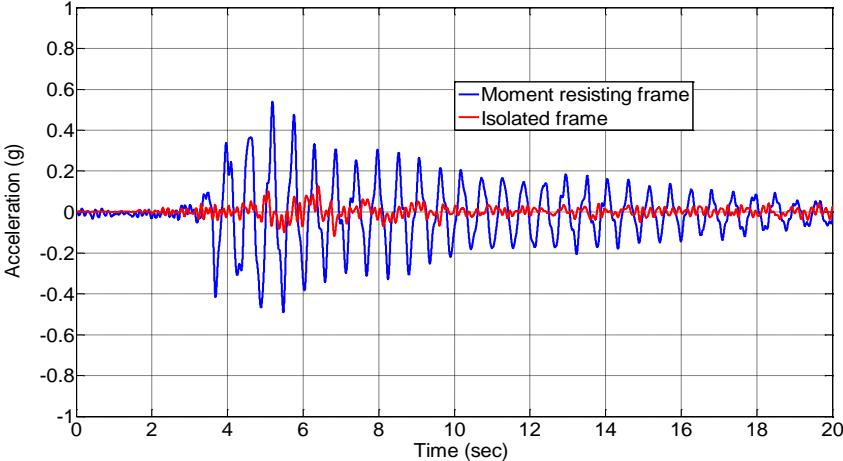

Figure 8. Acceleration time history of different structures

CONCLUSIONS

A family of small-scale building models was developed to facilitate demonstration of their dynamic properties and seismic responses in classroom situations. The main design objectives were: 1) the dynamic properties of the models should be the same as those of real buildings; 2) the analytical models of these structures should be simple, yet good enough to match the test results; and 3) procurement of materials and construction of these models should be simple and quick. The developed models are made using readily available steel components. The simplicity and the small size of the models make them easily reproducible and very suitable for teaching purposes. The vibration properties and the acceleration time histories, measured in a series of experiments, show that the seismic performance of these models is in the range of real structures.

However, the accelerations that are chosen to excite these structures should be selected with significant caution to avoid possible damage of the models due to yielding, buckling or overturning. This careful selection of accelerations combined with protection from corrosion through paint coatings can significantly extend the lifetime of these models.

REFERENCES

- Aschheim M., Simsir C. (2006), Low-cost moment-resistant frame structures for student laboratory projects on performance-based seismic design, *Proceedings of the 8th National Conference on Earthquake Engineering*, April 18 - April 22, San Francisco, CA
- Crewe A.J., Yang Y.S., Lin C.C.J and Daniell W.E. (2008), Earthquake engineering public engagement activities in Taiwan, *Proceedings of the 14th World Conference on Earthquake Engineering*, October 12-17, Beijing, China
- Hamaguchi H., Higashino M. (2000), Development of low-friction factor sliding isolation device, *12WCEE*, Auckland, New Zealand
- Kelly JM. (1997), *Earthquake Resistant Design with Rubber*. Springer: London
- Lignos D.G., Krawinkler H. and Whittaker A.S. (2008), Shaking table collapse tests of two scale models of a 4-story moment resisting steel frame, *Proceedings of the 14th World Conference on Earthquake Engineering*, October 12-17, Beijing, China
- Mendoza B., Perez M., Langdon N., Nelson N., Stojadinovic B. and Sitar N. (2008), Earthquake risk education module for high-school students", *Proceedings of the 14th World Conference on Earthquake Engineering*, October 12-17, Beijing, China
- Mills, R.S., Krawinkler H. (1980), Earthquake simulation study of a steel frame small-scale model", *Proceedings of the 7th World Conference on Earthquake Engineering*, Turkey
- Simsir C., Aschheim M. (2004), Low-cost accelerometers for student laboratory projects, *Proceedings of the 13th World Conference on Earthquake Engineering*, August 1-8, 2004, Vancouver, B.C., Canada
- Terranova B., Mosqueda G. (2009), Design and verification of a seismic isolation system for K – 12 educational models, University at Buffalo